

MainlineMedical

Your Anesthesia & Respiratory Specialist

We are with you.
Every step of the way.



Intubrite Laryngoscopes Pg. 47



STAT Orange Capnography Pg. 115



NebuTech Nebulizer + Filter Pg. 121



SunStim Pro Nerve Stimulator Pg. 78



HEPA + COVID-19 Filtration Pg. 135

INSIDE:
COVID-19 Management
Respiratory Care
Airways & Intubation

Always FREE Shipping Online with \$500+ Orders • MainlineMedical.com

Our biggest catalog yet – with even more online!



MainlineMedical.com



Find What You Need

- AIRWAY MANAGEMENT4-37
- DISPOSABLE LARYNGOSCOPES38-46
- FIBER OPTIC LARYNGOSCOPES47-65
- CONVENTIONAL LARYNGOSCOPES66-77
- DIAGNOSTICS.....78-97
- PATIENT CARE & SAFETY98-102
- GENERAL ANESTHESIA 103-111
- RESPIRATORY CARE 112-149
- INTUBATION AIDS 150-157
- INDEX..... 158-159
- COVID-19 TREATMENT.....160-163



Adult EtCO₂/O₂ Delivery Nasal Cannula
Simultaneously Provide Oxygen While Capturing End Tidal Gas

• LATEX FREE • DISPOSABLE •

- Dual nasal cannula simultaneously provides oxygen to both nostrils while obtaining CO₂ sampling during spontaneous breathing
- Effectively captures undiluted end tidal gas sample
- Designed to prevent mixing of fresh oxygen with CO₂
- 3-Channel tubing prevents kinking
- Includes male/female adapter with luer lock connector
- Available with Fits-All Connector for O₂ or oxygen connections

Item	Description	Length	Qty	\$
4107	EtCO ₂ Cannula	7'	25	\$53.95
4107F	EtCO ₂ Cannula w/ Fits-All Connector	7'	25	\$56.95
4110	EtCO ₂ Cannula	10'	25	\$62.95
4110F	EtCO ₂ Cannula w/ Fits-All Connector	10'	25	\$66.95
4114	EtCO ₂ Cannula	14'	25	\$71.95
4114F	EtCO ₂ Cannula w/ Fits-All Connector	14'	25	\$74.95

Fits-All Connector



Blue Mask Head Harness
Webbed Head Portion Permits Ventilation

• LATEX FREE • DISPOSABLE •

- Light blue molded head harness
- Equal distribution of pressure over large area
- Designed to ensure proper fit

Item	Description	Size	Qty	\$
4-1054-01	Blue Mask Head Harness	Adult	1	\$5.95



SunStim™ Plus
Peripheral Nerve Stimulator

• LATEX FREE • REUSABLE •

- Features two 60 milliamp burst simulation at 50 Hz, separated by 0.75 seconds
- Develops optimal output to ensure supramaximal stimulation: Output current is fully adjustable from 0-70mA
- Features 50 and 100Hz Tetanus, TOF and DBS

Item	Description	Qty	\$
8-1053-62	SunStim Plus Peripheral Nerve Stimulator	1	\$229.95

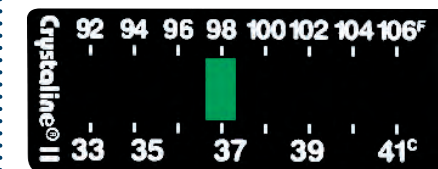

Crystalline™ II Temp Trend Indicator

Best Selling Temperature Strip

• LATEX FREE • DISPOSABLE •

- Accurate core adjusted 92° - 106°F (33° - 41°C)
- Handy wall mount dispenser box
- Economical

Item	Description	Qty	\$
8-5101-01	Crystalline II Temp Trend Indicator	100	\$87.95

HEPA Filter

Effectively Filters for COVID-19

• LATEX FREE • DISPOSABLE •



- Bacterial/viral filtration
- Sampling port
- 99.9999% Filtration efficacy
- 22mm OD/15mm ID x 22mm ID/15mm OD
- 62 mL Deadspace
- 250 mL - 1500 mL Tidal volume

Item	Description	Qty	\$
FH603074	HEPA Filter	50	\$169.95

IGuard™ Eye Protector
Non-Allergenic Adhesive

• LATEX FREE • STERILE • DISPOSABLE •



- Provides comfortable, effective patient eye protection
- Available in adult and pediatric sizes
- Non-allergenic adhesive
- Individually packaged

Item	Description	Qty	\$
9-0210-00	IGuard, Adult	25	\$132.95
9-0210-21	IGuard, Pediatric	25	\$134.95

Endotracheal Tube Introducer

The Original Blue Bougie

• LATEX FREE • STERILE • DISPOSABLE •

- Used to guide the endotracheal tube during difficult intubations by sliding over the introducer
- Designed with proper stiffness for ease of insertion
- Calibration markings enables safe and easy monitoring of insertion distance
- All 70 cm in length
- Coudé tip facilitates insertion in adults
- Manufactured from low density polyethylene



Item	Description	Size	Qty	\$
9-0212-70	Adult Coudé, Fits 6-11 mm Tubes	15 Fr	10	\$63.95
9-0212-72	Adult Straight, Fits 6-11 mm Tubes	15 Fr	10	\$63.95
9-0211-70	Pediatric Coudé/ Straight Tip, Fits 4-6 mm Tubes	10 Fr	10	\$63.95



Non-Vented Berman Airway
Length Imprinted on Airway

• LATEX FREE • DISPOSABLE •

- Length (mm) printed on airway
- Color coded for easy identification
- Non-sterile

Pk/10	Pk/50	Description	Size	mm	\$/10	\$/50
1-1220-40	1-1218-40	Newborn, Pink	00	40	\$3.95	\$14.95
1-1220-50	1-1218-50	Infant, Blue	0	50	\$3.95	\$14.95
1-1220-60	1-1218-60	Small Child, Black	1	60	\$3.95	\$14.95
1-1220-70	1-1218-70	Child, White	2	70	\$3.95	\$14.95
1-1220-80	1-1218-80	Small Adult, Green	3	80	\$3.95	\$14.95
1-1220-90	1-1218-90	Med. Adult, Yellow	4	90	\$3.95	\$14.95
1-1220-99	1-1218-99	Large Adult, Lavender	5	100	\$3.95	\$14.95
1-1220-11	1-1218-11	XL Adult, Orange	6	110	\$3.95	\$14.95



Vented Berman Airway
Facilitates Airflow

• LATEX FREE • DISPOSABLE •

- Vented design allows air to flow from either side
- Satin smooth finish
- Reinforced bite block
- Size marked on flange
- Individually wrapped

Item	Description	mm	Qty	\$
1-1515-40	Newborn Vented Berman Airway	40	50	\$18.95
1-1515-50	Infant Vented Berman Airway	50	50	\$18.95
1-1515-60	Small Child Vented Berman Airway	60	50	\$18.95
1-1515-70	Child Vented Berman Airway	70	50	\$22.95
1-1515-80	Small Adult Vented Berman Airway	80	50	\$17.95
1-1515-90	Med. Adult Vented Berman Airway	90	50	\$21.95
1-1515-99	Large Adult Vented Berman Airway	100	50	\$22.95



1-1508-00
Berman Airway
Crash Cart Kit
Includes:
7 Berman Airways
Sizes:
40 mm, 50 mm, 60 mm,
70 mm, 80 mm, 90 mm,
100 mm, 110 mm
\$11.95 10 sets
of 8 sizes

Color Coded Berman Airway
Easy Visual Identification

• LATEX FREE • DISPOSABLE •

- Vented design to allow air flow from either side
- Color coded for easy identification
- Made of polyethylene plastic
- Non-sterile
- Individually wrapped

Pk/10	Pk50	Description	Size	mm	\$/10	\$/50
1-1508-40	1-1506-40	Newborn, Pink	00	40	\$3.95	\$13.95
1-1508-50	1-1506-50	Infant, Blue	0	50	\$3.95	\$13.95
1-1508-60	1-1506-60	Small Child, Black	1	60	\$3.95	\$13.95
1-1508-70	1-1506-70	Child, White	2	70	\$3.95	\$13.95
1-1508-80	1-1506-80	Small Adult, Green	3	80	\$3.95	\$13.95
1-1508-90	1-1506-90	Med. Adult, Yellow	4	90	\$3.95	\$13.95
1-1508-99	1-1506-99	Large Adult, Red	5	100	\$3.95	\$13.95
1-1508-11	1-1506-11	XL Adult, Orange	6	110	\$3.95	\$13.95



Cath-Guide Airway

Three Channel Design for Suctioning, Gas Exchange

• LATEX FREE • DISPOSABLE •

- Flexible vinyl with a rigid bite block
- Guedel-style with three internal channels
- Center channel establishes the path for a suction catheter
- Two other channels assure the airway remains open for gas exchange
- Individually wrapped

Item	Description	Size	mm	Qty	\$
1-1160-55	Infant Cath-Guide Airway	5.5	55	48	\$54.95
1-1160-60	Small Child Cath-Guide Airway	6.0	60	48	\$54.95
1-1160-70	Child Cath-Guide Airway	7.0	70	48	\$54.95
1-1160-80	Small Adult Cath-Guide Airway	8.0	80	48	\$54.95
1-1160-90	Med. Adult Cath-Guide Airway	9.0	90	48	\$54.95
1-1160-10	Adult Cath-Guide Airway	10.0	100	48	\$54.95
1-1160-11	Large Adult Cath-Guide Airway	11.0	110	48	\$54.95
1-1160-12	XL Adult Cath-Guide Airway	12.0	120	48	\$54.95



Jaw Spreader Kit

Help Facilitate Breathing During Convulsions, Seizures

• LATEX FREE • DISPOSABLE •

- Aids in spreading the jaws during convulsive seizures and in extensive jaw or neck resections
- Universal design firmly holds the tongue down while keeping jaw open for airway placement for adults and children
- Features a deep groove to engage teeth and a butterfly finger grip for greater leverage

Item	Description	Qty	\$
9-3042-00	Jaw Spreader Kit	1	\$8.95



Traditional Guedel Airways

One Piece Construction with Bite Block

• LATEX FREE • DISPOSABLE •

- Firm, polyethylene plastic
- Built-in bite block
- Individually wrapped

Pk/10	Pk/50	Description	Size	mm	\$/10	\$/50
1-1501-60	1-1500-60	Small Child, Black	1	60	\$6.95	\$25.95
1-1501-70	1-1500-70	Child, White	2	70	\$6.95	\$25.95
1-1501-80	1-1500-80	Small Adult, Green	3	80	\$6.95	\$25.95
1-1501-90	1-1500-90	Med. Adult, Yellow	4	90	\$6.95	\$25.95



One Piece Guedel Airways

Soft Tip Reduces Tissue Damage

• LATEX FREE • DISPOSABLE •

- One piece design helps significantly reduce risks associated with separate bite blocks
- Softer second material on flange reduces the potential for dental damage

Item	Description	Size	mm	Qty	\$
1-1100-00	Premature, Clear	000	35	50	\$37.95
1-1100-10	Newborn, Pink	00	50	50	\$37.95
1-1100-11	Infant, Blue	0	55	50	\$37.95
1-1100-01	Small Child, Black	1	65	50	\$37.95
1-1100-15	Child, White	1.5	70	50	\$37.95
1-1100-02	Small Adult, Green	2	80	50	\$37.95
1-1100-03	Med. Adult, Yellow	3	90	50	\$37.95
1-1100-04	Large Adult, Red	4	100	50	\$37.95
1-1100-05	XL Adult, Orange	5	120	50	\$37.95

vital signs



Color Coded Guedel Airways

Reinforced Bite Block

• LATEX FREE • DISPOSABLE •

- Satin smooth finish
- Size imprinted on flange
- 100% polyethylene plastic
- Individually wrapped

Item	Description	Size	mm	Qty	\$
1-1516-60	Small Child	1	60	50	\$40.95
1-1516-70	Child	2	70	50	\$40.95
1-1516-80	Small Adult	3	80	50	\$40.95
1-1516-90	Med. Adult	4	90	50	\$40.95
1-1516-99	Large Adult	5	100	50	\$40.95



Clear PVC Guedel Airway

Color Coded Bite Block

• LATEX FREE • DISPOSABLE •

- Rigid built-in bite block
- Smooth, soft, clear PVC finish
- Color coded for easy identification
- Non-sterile
- Individually wrapped

Pk/10	Pk/50	Description	Size	mm	\$/10	\$/50
1-5010-30	1-1521-30	Premature, Clear	000	30	\$12.95	\$43.95
1-5010-20	1-1521-20	Newborn, Pink	00	40	\$12.95	\$43.95
1-5010-10	1-1521-10	Infant, Blue	0	50	\$12.95	\$43.95
1-5010-01	1-1521-01	Small Child, Black	1	60	\$12.95	\$43.95
1-5010-02	1-1521-02	Child, White	2	70	\$12.95	\$43.95
1-5010-03	1-1521-03	Small Adult, Green	3	80	\$12.95	\$43.95
1-5010-04	1-1521-04	Adult, Yellow	4	90	\$12.95	\$43.95
1-5010-05	1-1521-05	Large Adult, Red	5	100	\$12.95	\$43.95
1-5010-06	1-1521-06	XL Adult, Orange	6	110	\$12.95	\$43.95



Guedel Airway

Soft Clear Airway

• LATEX FREE • DISPOSABLE •

- Ruschelit PVC
- Color coded for easy identification
- Siliconized
- Satin finish

Item	Description	Size	mm	Qty	\$
1-2470-01	Premature, Clear	000	30	10	\$23.95
1-2470-02	Newborn, Pink	00	40	10	\$23.95
1-2470-03	Infant, Blue	0	50	10	\$23.95
1-2470-10	Small Child, Black	1	60	10	\$23.95
1-2470-20	Child, White	2	70	10	\$23.95
1-2470-30	Small Adult, Green	3	80	10	\$23.95
1-2470-40	Med. Adult, Yellow	4	90	10	\$23.95
1-2470-50	Large Adult, Red	5	100	10	\$23.95
1-2470-60	XL Adult, Orange	6	110	10	\$23.95



Sterile Guedel Airways

Color Coded

• LATEX FREE • STERILE • DISPOSABLE •

- Smooth finish with integrated bite block
- Soft PVC and nitrile blend
- Individually wrapped

Item	Description	Size	mm	Qty	\$
1-3891-03	Premature, Clear	000	35	50	\$28.95
1-3891-02	Newborn, Blue	00	50	50	\$28.95
1-3891-01	Infant, Black	0	60	50	\$28.95
1-3891-10	Small Child, White	1	70	50	\$28.95
1-3891-20	Small Adult, Green	2	80	50	\$28.95
1-3891-30	Med. Adult, Orange	3	90	50	\$28.95
1-3891-40	Large Adult, Red	40	100	50	\$28.95



Williams Intubating Airway
Male & Female Sizing

• LATEX FREE • DISPOSABLE •

- Built-in bite block
- Guides fiber optic laryngoscope placement
- One piece construction

Item	Description	Size	I.D.	Qty	\$
1-1503-09	Adult Female, Yellow	9 cm	7.5 mm	10	\$32.95
1-1503-10	Adult Male, Pink	10 cm	8.5 mm	10	\$32.95



Ovassapian Fiber Optic Airway
For Use with Fiber Optic Endoscopes

• LATEX FREE • DISPOSABLE •

- Minimize the risk of disconnection or displacement of the ET tube
- Tubular proximal half functions as a bite block
- Individually wrapped

Item	Description	I.D.	Qty	\$
1-6075-00	Ovassapian Fiber Optic Airway	8.0-9.0 mm	5	\$32.95



Williams Intubating Airway
Sterile Oral Airway

• LATEX FREE • STERILE • DISPOSABLE •

- Effectively intubates the trachea
- Guides fiber optic laryngoscope placement
- Individually wrapped

Item	Description	Size	I.D.	Qty	\$
1-3890-09	Adult Female, Orange	9 cm	7.5 mm	10	\$34.95
1-3890-10	Adult Male, Pink	10 cm	8.5 mm	10	\$34.95



Hinged Berman Airway
Ideal for Difficult Intubations

• LATEX FREE • DISPOSABLE •

- Widened anterior/posterior diameter provides a better airway between tongue and pharynx
- Design allows it to be opened longitudinally to set aside the mouth while keeping the ET tube in place
- Provides 400% more air through the passageway at all times

Item	Description	Size	Qty	\$
1-1514-80	Berman Pharyngeal Airway	8 cm	10	\$66.95
1-1514-85	Berman Pharyngeal Airway	8 cm	50	\$293.95



QuickTrach® Cricothyroidotomy Kit
Reduce Risk of Trachea Tissue Damage

• LATEX FREE • STERILE • DISPOSABLE •

- Removable stopper reduces risk of damage to the rear wall of the trachea
- Conical needle tip guarantees the smallest necessary stoma and reduces bleeding
- The syringe allows identification of the trachea by aspirating air
- Tubing for immediate ventilation
- Kits include one sterile QuickTrach, 10 mm syringe, connecting tube with 15 mm adapter and cushion neckband

Item	Description	Size	Qty	\$
1-2090-40	QuickTrach Cricothyroidotomy Kit	4 mm	1	\$196.95
1-2090-20	QuickTrach Cricothyroidotomy Kit	2 mm	1	\$196.95

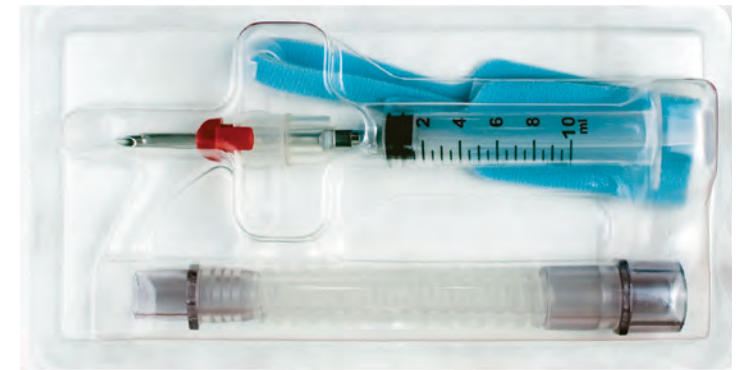

QuickTrach II® Cricothyroidotomy Kit
Includes Inflatable Cuff

• LATEX FREE • STERILE • DISPOSABLE •

- Adult size: 4 mm ID
- Pre-assembled for immediate use
- Specially grinded needle tip makes preparatory incision via scalpel unnecessary and reduces the risk of bleeding
- Stopper prevents needle from being inserted too deep
- Neck tape for safe fixation
- Box or cylinder packaging options
- Ideal for emergency bags

Item	Description	Qty	\$
1-3010-04	QuickTrach II Box Set	1	\$153.95
1-3010-94	QuickTrach II Cylinder Set	1	\$153.95

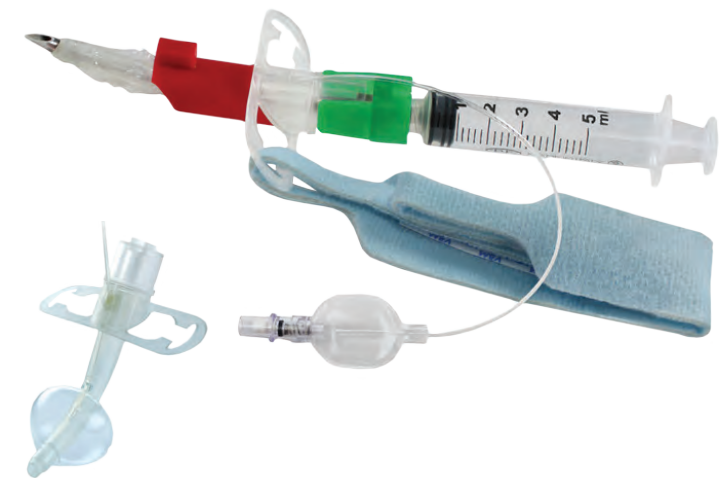

VBM Medical Inc.

Emergency Cricothyroidotomy Kit
Designed for Fast Emergency Airway Access

• LATEX FREE • STERILE • DISPOSABLE •

- Veress needle design confirms entry into the trachea and indicates any subsequent contact with the posterior wall
- 6 mm core cricothyroidotomy tube enables spontaneous breathing and Soft Seal cuff secures the airway
- Components packaged in "ready" state - in sequence of use
- Ideal for inclusion and trauma bags

Item	Description	Qty	\$
1-4650-60	Emergency Cricothyroidotomy Kit	1	\$187.95



PORTEX



Adjustable Flange Naso
Soft Neoprene Construction

• LATEX FREE • STERILE • DISPOSABLE •

- Beveled tip to reduce trauma
- Helps to prevent nasal passage damage
- 13 sizes available

Item	Size	O.D.	Qty	\$
1-5072-12	12 Fr	4.0 mm	10	\$45.95
1-5072-14	14 Fr	4.7 mm	10	\$45.95
1-5072-16	16 Fr	5.3 mm	10	\$45.95
1-5072-18	18 Fr	6.0 mm	10	\$45.95
1-5072-20	20 Fr	6.7 mm	10	\$45.95
1-5072-22	22 Fr	7.3 mm	10	\$45.95
1-5072-24	24 Fr	8.0 mm	10	\$45.95
1-5072-26	26 Fr	8.7 mm	10	\$45.95
1-5072-28	28Fr	9.3mm	10	\$45.95
1-5072-30	30Fr	10mm	10	\$45.95
1-5072-32	32Fr	10.7mm	10	\$45.95
1-5072-34	34Fr	11.3mm	10	\$45.95
1-5072-36	36Fr	12mm	10	\$45.95



Adjustable Flange Naso
Silicone Coated Latex

• LATEX • STERILE • DISPOSABLE •

- Made of silicone-coated latex
- Soft to avoid nasal passage damage

Item	Size	O.D.	Qty	\$
1-8520-20	20 Fr	6.7 mm	10	\$73.95
1-8520-22	22 Fr	7.3 mm	10	\$73.95
1-8520-24	24 Fr	8.0 mm	10	\$73.95
1-8520-26	26 Fr	8.7 mm	10	\$73.95
1-8520-28	28 Fr	9.3 mm	10	\$73.95
1-8520-30	30 Fr	10 mm	10	\$73.95
1-8520-32	32 Fr	10.7 mm	10	\$73.95
1-8520-34	34 Fr	11.3 mm	10	\$73.95
1-8520-36	36 Fr	12 mm	10	\$73.95



Adjustable Flange Naso
Mediprene Construction

• LATEX FREE • STERILE • DISPOSABLE •

- Mediprene construction
- Rounded tip
- Full size range, including pediatric

Item	Size	O.D.	Qty	\$
1-8542-12	12 Fr	4.0 mm	5	\$75.95
1-8542-14	14 Fr	4.7 mm	5	\$75.95
1-8542-16	16 Fr	5.3 mm	5	\$75.95
1-8542-18	18 Fr	6.0 mm	5	\$75.95
1-8542-20	20 Fr	6.7 mm	5	\$75.95
1-8542-22	22 Fr	7.3 mm	5	\$75.95
1-8542-24	24 Fr	8.0 mm	5	\$75.95
1-8542-26	26 Fr	8.7 mm	5	\$75.95
1-8542-28	28 Fr	9.3 mm	5	\$75.95
1-8542-30	30 Fr	10 mm	5	\$75.95
1-8542-32	32 Fr	10.7 mm	5	\$75.95
1-8542-34	34 Fr	11.3 mm	5	\$75.95
1-8542-36	36 Fr	12 mm	5	\$75.95



Robertazzi Naso
Kink Resistant Design

• LATEX FREE • STERILE • DISPOSABLE •

- Smooth, soft beveled tip for comfortable insertion
- Resilient - resists collapse or kinking
- Soft material avoids damaging the nasal passage

Item	Size	O.D.	Qty	\$
1-2312-20	20 Fr	6.7 mm	10	\$46.95
1-2312-22	22 Fr	7.3 mm	10	\$46.95
1-2312-24	24 Fr	8.0 mm	10	\$46.95
1-2312-26	26 Fr	8.7 mm	10	\$46.95
1-2312-28	28 Fr	9.3 mm	10	\$46.95
1-2312-30	30 Fr	10 mm	10	\$46.95
1-2312-32	32 Fr	10.7 mm	10	\$46.95
1-2312-34	34 Fr	11.3 mm	10	\$46.95
1-2312-36	36 Fr	12 mm	10	\$46.95

MainlineMedical.com
more great products online



Robertazzi Naso
Latex Material

• LATEX • STERILE • DISPOSABLE •

- Resists collapse or kinking
- Smooth, soft surface for easy insertion
- Processed to reduce latex protein

Item	Size	O.D.	Qty	\$
1-5076-20	20 Fr	6.7 mm	10	\$26.95
1-5076-22	22 Fr	7.3 mm	10	\$26.95
1-5076-24	24 Fr	7.6 mm	10	\$26.95
1-5076-26	26 Fr	8.6 mm	10	\$26.95
1-5076-28	28 Fr	9.3 mm	10	\$26.95
1-5076-30	30 Fr	10 mm	10	\$26.95
1-5076-32	32 Fr	10.7 mm	10	\$26.95
1-5076-34	34 Fr	11.2 mm	10	\$26.95
1-5076-36	36 Fr	12 mm	10	\$26.95

Latex Robertazzi Kit
with Sterile Lubricating Jelly

Item	Size	Qty	\$
1-5076-04	20 Fr, 24 Fr, 28 Fr, 32 Fr	1	\$12.95
1-5076-06	22 Fr, 24 Fr, 26 Fr, 28 Fr, 30 Fr, 32 Fr	1	\$17.95
1-5076-09	20 Fr, 22 Fr, 24 Fr, 26 Fr, 28 Fr, 30 Fr, 32 Fr, 34 Fr, 36 Fr	1	\$27.95



Robertazzi Naso
Flexible & Soft

• LATEX FREE • STERILE • DISPOSABLE •

- Beveled tip to reduce trauma
- Smooth, resilient surface
- Soft and flexible; comparable to latex
- Multi-size kit available

Item	Size	O.D.	Qty	\$
1-5075-20	20 Fr	6.7 mm	10	\$35.95
1-5075-22	22 Fr	7.3 mm	10	\$35.95
1-5075-24	24 Fr	7.6 mm	10	\$35.95
1-5075-26	26 Fr	8.6 mm	10	\$35.95
1-5075-28	28 Fr	9.3 mm	10	\$35.95
1-5075-30	30 Fr	10 mm	10	\$35.95
1-5075-32	32 Fr	10.7 mm	10	\$35.95
1-5075-34	34 Fr	11.2 mm	10	\$35.95
1-5075-36	36 Fr	12 mm	10	\$35.95

Robertazzi Kit
with Sterile Lubricating Jelly

Item	Size	Qty	\$
1-5075-04	20 Fr, 24 Fr, 28 Fr, 32 Fr	1	\$19.95
1-5075-06	22 Fr, 24 Fr, 26 Fr, 28 Fr, 30 Fr, 32 Fr	1	\$27.95
1-5075-09	20 Fr, 22 Fr, 24 Fr, 26 Fr, 28 Fr, 30 Fr, 32 Fr, 34 Fr, 36 Fr	1	\$39.95

PORTEX™



PVC Naso
Maximum Kink Resistant

• LATEX FREE • STERILE • DISPOSABLE •

- Smooth satin finish for easy insertion
- Made of implant-tested polyvinyl chloride plastic
- Beveled edge for patient comfort

Item	Size	O.D.	Qty	\$
1-3400-60	18 Fr	8.0 mm	10	\$43.95
1-3400-70	21 Fr	9.5 mm	10	\$43.95
1-3400-80	24 Fr	10.5 mm	10	\$43.95
1-3400-90	27 Fr	12.0 mm	10	\$43.95

MainlineMedical.com
more great products online

flexicare
TOTAL QUALITY • TOTAL CARE



NasoClear® PVC Naso
Sizes Labeled Clearly

• LATEX FREE • STERILE • DISPOSABLE •

- Clear airway provides visual confirmation of any blockages
- Large flared opening prevents airway from traveling down nasal passage

Item	Size	O.D.	Qty	\$
1-8950-40	20 Fr	4.0 mm	10	\$19.95
1-8950-50	24 Fr	5.0 mm	10	\$19.95
1-8950-60	28 Fr	6.0 mm	10	\$19.95
1-8950-70	30 Fr	7.0 mm	10	\$19.95
1-8950-75	32 Fr	7.5 mm	10	\$19.95
1-8950-80	34 Fr	8.0 mm	10	\$19.95
1-8950-85	36 Fr	8.5 mm	10	\$19.95
1-8950-90	38 Fr	9.0 mm	10	\$19.95

flexicare
TOTAL QUALITY • TOTAL CARE

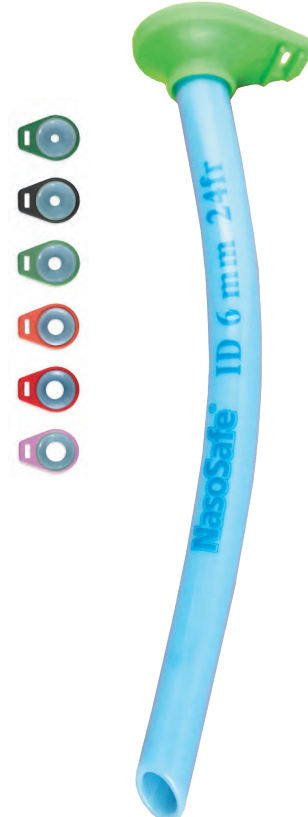

NasoSafe® PVC Naso
Patented Safety Grip Holds Airway Securely in Place

• LATEX FREE • STERILE • DISPOSABLE •

- Ideal for use when oral passage is not accessible - suitable for nasal suctioning
- 360° swiveling safety grip allows optimal positioning for patient comfort
- Rounded edge tip and angle cut helps reduce risk of injury during intubation

Item	Size	O.D.	Qty	\$
1-8542-12	12 Fr	4.0 mm	5	\$75.95
1-8542-14	14 Fr	4.7 mm	5	\$75.95
1-8542-16	16 Fr	5.3 mm	5	\$75.95
1-8542-18	18 Fr	6.0 mm	5	\$75.95
1-8542-20	20 Fr	6.7 mm	5	\$75.95
1-8542-22	22 Fr	7.3 mm	5	\$75.95

SALTER LABS



Flex-Tip Naso
Easy Insertion & Advancement of Tube

• LATEX FREE • STERILE • DISPOSABLE •

- Patented tip design facilitates insertion and tube advancement
- Flex-tips are clinically proven to reduce nasal bleeding
- Soft, flexible PVC with trumpet-style design

Item	Size	O.D.	Qty	\$
H-NPA-12	12 Fr	4.0 mm	10	\$33.95
H-NPA-14	14 Fr	4.7 mm	10	\$33.95
H-NPA-16	16 Fr	5.3 mm	10	\$33.95
H-NPA-18	18 Fr	6.0 mm	10	\$33.95
H-NPA-20	20 Fr	6.7 mm	10	\$33.95
H-NPA-22	22 Fr	7.3 mm	10	\$33.95
H-NPA-24	24 Fr	8.0 mm	10	\$33.95
H-NPA-26	26 Fr	8.7 mm	10	\$33.95
H-NPA-28	28 Fr	9.3 mm	10	\$33.95
H-NPA-30	30 Fr	10.0 mm	10	\$33.95
H-NPA-32	32 Fr	10.7 mm	10	\$33.95
H-NPA-34	34 Fr	11.3 mm	10	\$33.95
H-NPA-36	36 Fr	12.0 mm	10	\$33.95

SunMed



PVC Naso
Beveled Tip

• LATEX FREE • STERILE • DISPOSABLE •

- Beveled tip to reduce trauma
- 15 mm fitting
- Multi-size kit available

Item	Size	O.D.	Qty	\$
1-5073-12	12 Fr	4.0 mm	10	\$26.95
1-5073-14	14 Fr	4.7 mm	10	\$26.95
1-5073-16	16 Fr	5.3 mm	10	\$26.95
1-5073-18	18 Fr	5.9 mm	10	\$26.95
1-5073-20	20 Fr	6.7 mm	10	\$26.95
1-5073-24	24 Fr	7.6 mm	10	\$26.95
1-5073-26	26 Fr	8.6 mm	10	\$26.95
1-5073-28	28 Fr	9.3 mm	10	\$26.95
1-5073-30	30 Fr	10 mm	10	\$26.95
1-5073-32	32 Fr	10.7 mm	10	\$26.95
1-5073-34	34 Fr	11.2 mm	10	\$26.95
1-5073-36	36 Fr	12 mm	10	\$26.95

PVC Naso Kit
with Sterile Lubricating Jelly

Item	Size	Qty	\$
1-5073-05	20 Fr, 24 Fr, 28 Fr, 32 Fr, 36 Fr	1	\$13.95

RUSCH
A TELEFLEX COMPANY



PVC Naso
Smooth, Rounded Edges for Comfort

• LATEX FREE • STERILE • DISPOSABLE •

- 38° beveled tip anatomically designed to reduce mucosal trauma
- Smooth, soft compliant PVC and round edges provide improved patient comfort

Item	Size	O.D.	Qty	\$
1-2000-25	12 Fr	3.0 mm	10	\$36.95
1-2000-30	14 Fr	4.6 mm	10	\$36.95
1-2000-35	16 Fr	5.3 mm	10	\$36.95
1-2000-40	18 Fr	6.0 mm	10	\$36.95
1-2000-45	19 Fr	6.3 mm	10	\$36.95
1-2000-50	20 Fr	6.6 mm	10	\$36.95
1-2000-55	22 Fr	7.3 mm	10	\$36.95
1-2000-60	24 Fr	8.0 mm	10	\$36.95
1-2000-65	26 Fr	8.6 mm	10	\$36.95
1-2000-70	28 Fr	9.3 mm	10	\$36.95
1-2000-75	30 Fr	10.0 mm	10	\$36.95
1-2000-80	32 Fr	10.6 mm	10	\$36.95
1-2000-85	34 Fr	11.3 mm	10	\$36.95
1-2000-90	36 Fr	12.0 mm	10	\$36.95



Flex-Tip® Endotracheal Tubes
Tapered Distal Tip for Non-Traumatic Intubation

• LATEX FREE • STERILE • DISPOSABLE •

- Designed to facilitate rapid, non-traumatic intubation
- Unique, patented design has a flexible, curved, centered, tapered distal tip
- Tapered tip is designed to flex and slide gently along the airway through the larynx, down the trachea on its curved backside without catching on airway tissue

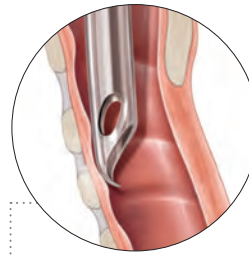

Tapered tip slides more gently along airway compared to traditional ET tubes

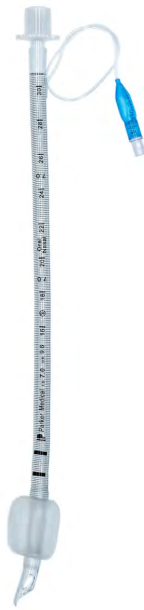
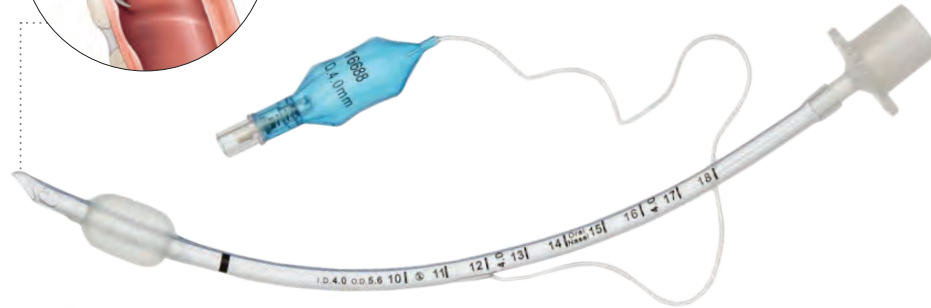

Reinforced Cuffed

Item	I.D.	Qty	\$
H-PFRC-55-5	5.5 mm	5	\$100.95
H-PFRC-60-5	6.0 mm	5	\$100.95
H-PFRC-65-5	6.5 mm	5	\$100.95
H-PFRC-70-5	7.0 mm	5	\$100.95
H-PFRC-75-5	7.5 mm	5	\$100.95
H-PFRC-80-5	8.0 mm	5	\$100.95
H-PFRC-85-5	8.5 mm	5	\$100.95
H-PFRC-90-5	9.0 mm	5	\$100.95
H-PFRC-95-5	9.5 mm	5	\$100.95



Reinforced Uncuffed

Item	I.D.	Qty	\$
H-PFRU-30-5	3.0 mm	5	\$100.95
H-PFRU-35-5	3.5 mm	5	\$100.95
H-PFRU-40-5	4.0 mm	5	\$100.95
H-PFRU-45-5	4.5 mm	5	\$100.95
H-PFRU-50-5	5.0 mm	5	\$100.95



Low Profile Cuffed

Item	I.D.	Qty	\$
H-PFLP-40-10	4.0 mm	10	\$18.95
H-PFLP-50-10	5.0 mm	10	\$18.95
H-PFLP-55-10	5.5 mm	10	\$18.95
H-PFLP-60-10	6.0 mm	10	\$18.95
H-PFLP-65-10	6.5 mm	10	\$18.95
H-PFLP-70-10	7.0 mm	10	\$18.95
H-PFLP-75-10	7.5 mm	10	\$18.95
H-PFLP-80-10	8.0 mm	10	\$18.95
H-PFLP-85-10	8.5 mm	10	\$18.95
H-PFLP-90-10	9.0 mm	10	\$18.95
H-PFLP-95-10	9.5 mm	10	\$18.95



SEE THE DIFFERENCE • EXPERIENCE THE DIFFERENCE

SALTER LABS
FLEX-TIP ET TUBE

- NO GAP between tapered tip of ET tube and fiber bundle



STANDARD
ET TUBE

- Gap between leading edge of ET tube and fiber bundle
- Gap can catch on airway anatomy as the tube is 'railroaded' downward



Uncuffed

Item	I.D.	Qty	\$
H-PFUO-25-10	2.5 mm	10	\$20.95
H-PFUO-30-10	3.0 mm	10	\$20.95
H-PFUO-35-10	3.5 mm	10	\$20.95
H-PFUO-40-10	4.0 mm	10	\$20.95
H-PFUO-50-10	5.0 mm	10	\$20.95
H-PFUO-55-10	5.5 mm	10	\$20.95
H-PFUO-60-10	6.0 mm	10	\$20.95
H-PFUO-65-10	6.5 mm	10	\$20.95
H-PFUO-70-10	7.0 mm	10	\$20.95



Cuffed

Item	I.D.	Qty	\$
H-PFHV-40-10	4.0 mm	10	\$18.95
H-PFHV-50-10	5.0 mm	10	\$18.95
H-PFHV-55-10	5.5 mm	10	\$18.95
H-PFHV-60-10	6.0 mm	10	\$18.95
H-PFHV-65-10	6.5 mm	10	\$18.95
H-PFHV-70-10	7.0 mm	10	\$18.95
H-PFHV-75-10	7.5 mm	10	\$18.95
H-PFHV-80-10	8.0 mm	10	\$18.95
H-PFHV-85-10	8.5 mm	10	\$18.95
H-PFHV-90-10	9.0 mm	10	\$18.95
H-PFHV-95-10	9.5 mm	10	\$18.95



Cuffed with Stylet

Item	I.D.	Qty	\$
H-PFST-40-10	4.0 mm	10	\$34.95
H-PFST-50-10	5.0 mm	10	\$34.95
H-PFST-55-10	5.5 mm	10	\$34.95
H-PFST-60-10	6.0 mm	10	\$34.95
H-PFST-65-10	6.5 mm	10	\$34.95
H-PFST-70-10	7.0 mm	10	\$34.95
H-PFST-75-10	7.5 mm	10	\$34.95
H-PFST-80-10	8.0 mm	10	\$34.95
H-PFST-85-10	8.5 mm	10	\$34.95
H-PFST-90-10	9.0 mm	10	\$34.95
H-PFST-95-10	9.5 mm	10	\$34.95

MainlineMedical.com
more great products online



VentiSeal™ Cuffed
Softens at Body Temperature

• LATEX FREE • • STERILE • • DISPOSABLE •

- Kink resistant
- Double line depth guide
- Larger cuff enables even pressure distribution
- Thin walls of cuff reduce abrasive creases and folds
- Smooth material permits gentle conformity to tracheal contours

VentiSeal™ Cuffed Reinforced
Even Pressure Distribution

• LATEX FREE • • STERILE • • DISPOSABLE •

- Kink resistant
- Softens at body temperature
- Double line depth guide
- Larger cuff enables even pressure distribution
- Thin walls of cuff reduce abrasive creases and folds
- Smooth material permits gentle conformity to tracheal contours

Uncuffed
Oral/Nasal

• LATEX FREE • • STERILE • • DISPOSABLE •

- Kink resistant
- Hi-resolution radiopaque line
- Optimum size Murphy Eye

Reinforced Uncuffed
Optimum Size Murphy Eye

• LATEX FREE • • STERILE • • DISPOSABLE •

- Kink resistant
- Hi-resolution radiopaque line

Item	I.D.	Qty	\$
1-9710-40	4.0 mm	10	\$12.95
1-9710-45	4.5 mm	10	\$12.95
1-9710-50	5.0 mm	10	\$12.95
1-9710-55	5.5 mm	10	\$12.95
1-9710-60	6.0 mm	10	\$12.95
1-9710-65	6.5 mm	10	\$12.95
1-9710-70	7.0 mm	10	\$12.95
1-9710-75	7.5 mm	10	\$12.95
1-9710-80	8.0 mm	10	\$12.95
1-9710-85	8.5 mm	10	\$12.95
1-9710-90	9.0 mm	10	\$12.95
1-9710-95	9.5 mm	10	\$12.95
1-9710-10	10.0 mm	10	\$12.95
1-9710-15	10.5 mm	10	\$12.95
1-9710-11	11.0 mm	10	\$12.95

Item	I.D.	Qty	\$
1-9750-60	6.0 mm	10	\$236.95
1-9750-65	6.5 mm	10	\$236.95
1-9750-70	7.0 mm	10	\$236.95
1-9750-75	7.5 mm	10	\$236.95
1-9750-80	8.0 mm	10	\$236.95
1-9750-85	8.5 mm	10	\$236.95
1-9750-90	9.0 mm	10	\$236.95

Item	I.D.	Qty	\$
1-9610-25	2.5 mm	10	\$11.95
1-9610-30	3.0 mm	10	\$11.95
1-9610-35	3.5 mm	10	\$11.95
1-9610-40	4.0 mm	10	\$11.95
1-9610-45	4.5 mm	10	\$11.95
1-9610-50	5.0 mm	10	\$11.95
1-9610-55	5.5 mm	10	\$11.95
1-9610-60	6.0 mm	10	\$11.95
1-9610-65	6.5 mm	10	\$11.95
1-9610-70	7.0 mm	10	\$11.95
1-9610-75	7.5 mm	10	\$11.95
1-9610-80	8.0 mm	10	\$11.95
1-9610-85	8.5 mm	10	\$11.95

Item	I.D.	Qty	\$
1-9650-30	3.0 mm	10	\$209.95
1-9650-35	3.5 mm	10	\$209.95
1-9650-40	4.0 mm	10	\$209.95
1-9650-45	4.5 mm	10	\$209.95
1-9650-50	5.0 mm	10	\$209.95
1-9650-55	5.5 mm	10	\$209.95
1-9650-60	6.0 mm	10	\$209.95
1-9650-65	6.5 mm	10	\$209.95
1-9650-70	7.0 mm	10	\$209.95
1-9650-75	7.5 mm	10	\$209.95
1-9650-80	8.0 mm	10	\$209.95
1-9650-85	8.5 mm	10	\$209.95
1-9650-90	9.0 mm	10	\$209.95



Reinforced Cuffed
Spiral Stainless Steel

• LATEX FREE • • STERILE • • DISPOSABLE •

- Made from non-toxic PVC
- Curved stainless steel reinforced
- Features the same characteristics and benefits as SunMed's Murphy Eye endotracheal tubes

Item	I.D.	Qty	\$
1-7363-35	3.5 mm	10	\$159.95
1-7363-40	4.0 mm	10	\$159.95
1-7363-45	4.5 mm	10	\$159.95
1-7363-50	5.0 mm	10	\$159.95
1-7363-55	5.5 mm	10	\$159.95
1-7363-60	6.0 mm	10	\$159.95
1-7363-65	6.5 mm	10	\$159.95
1-7363-70	7.0 mm	10	\$159.95
1-7363-75	7.5 mm	10	\$159.95
1-7363-80	8.0 mm	10	\$159.95
1-7363-85	8.5 mm	10	\$159.95
1-7363-90	9.0 mm	10	\$159.95
1-7363-95	9.5 mm	10	\$159.95
1-7363-10	10 mm	10	\$159.95



Cuffed with Stylet
Preloaded Stylet

• LATEX FREE • • STERILE • • DISPOSABLE •

- Radiopaque strip embedded
- Smooth tube tip minimizes trauma during intubation
- Low pressure cuff with barrel profile minimizes capillary constriction within the tracheal
- 15 mm fitting adapter

Item	I.D.	Qty	\$
1-7343-30	3.0 mm	10	\$26.95
1-7343-35	3.5 mm	10	\$26.95
1-7343-40	4.0 mm	10	\$26.95
1-7343-45	4.5 mm	10	\$26.95
1-7343-50	5.0 mm	10	\$26.95
1-7343-55	5.5 mm	10	\$26.95
1-7343-60	6.0 mm	10	\$26.95
1-7343-65	6.5 mm	10	\$26.95
1-7343-70	7.0 mm	10	\$26.95
1-7343-75	7.5 mm	10	\$26.95
1-7343-80	8.0 mm	10	\$26.95
1-7343-85	8.5 mm	10	\$26.95
1-7343-90	9.0 mm	10	\$26.95
1-7343-95	9.5 mm	10	\$26.95
1-7343-10	10 mm	10	\$26.95

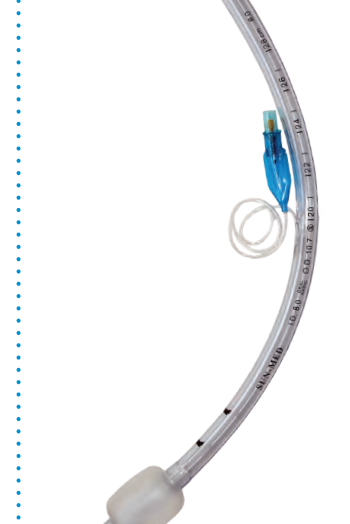

Cuffed
Murphy Eye Design

• LATEX FREE • • STERILE • • DISPOSABLE •

- Radiopaque strip embedded
- Smooth tube tip to minimize trauma during intubation
- Provides excellent tracheal wall seal
- Low pressure cuff with barrel profile minimizes capillary constriction within the tracheal
- 15 mm fitting adapter

Item	I.D.	Qty	\$
1-7333-30	3.0 mm	10	\$14.95
1-7333-35	3.5 mm	10	\$14.95
1-7333-40	4.0 mm	10	\$14.95
1-7333-45	4.5 mm	10	\$14.95
1-7333-50	5.0 mm	10	\$14.95
1-7333-55	5.5 mm	10	\$14.95
1-7333-60	6.0 mm	10	\$14.95
1-7333-65	6.5 mm	10	\$14.95
1-7333-70	7.0 mm	10	\$14.95
1-7333-75	7.5 mm	10	\$14.95
1-7333-80	8.0 mm	10	\$14.95
1-7333-85	8.5 mm	10	\$14.95
1-7333-90	9.0 mm	10	\$14.95
1-7333-95	9.5 mm	10	\$14.95
1-7333-10	10 mm	10	\$14.95

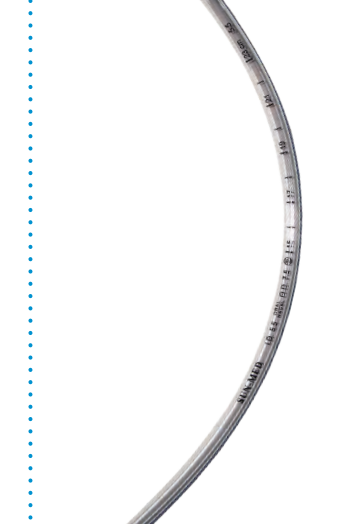

Uncuffed
Murphy Eye Design

• LATEX FREE • • STERILE • • DISPOSABLE •

- Radiopaque strip embedded
- Smooth tube tip minimizes trauma during intubation
- 15 mm fitting adapter

Item	I.D.	Qty	\$
1-7330-20	2.0 mm	10	\$10.95
1-7330-25	2.5 mm	10	\$10.95
1-7330-30	3.0 mm	10	\$10.95
1-7330-35	3.5 mm	10	\$10.95
1-7330-40	4.0 mm	10	\$10.95
1-7330-45	4.5 mm	10	\$10.95
1-7330-50	5.0 mm	10	\$10.95
1-7330-55	5.5 mm	10	\$10.95
1-7330-60	6.0 mm	10	\$10.95
1-7330-65	6.5 mm	10	\$10.95
1-7330-70	7.0 mm	10	\$10.95



Reinforced Uncuffed
Pediatric, Flexible

- LATEX FREE • STERILE • DISPOSABLE •

- Ruschelit® PVC
- Siliconized
- Spiral stainless steel reinforced
- Soft atraumatic tip designed not to fold back
- Connector is permanently fixed into the tube
- X-ray opaque line
- Graduated depth marks

Item	I.D.	Qty	\$
1-3600-25	2.5 mm	2	\$84.95
1-3600-30	3.0 mm	2	\$84.95
1-3600-35	3.5 mm	2	\$84.95
1-3600-40	4.0 mm	2	\$84.95
1-3600-45	4.5 mm	2	\$84.95
1-3600-50	5.0 mm	2	\$84.95
1-3600-55	5.5 mm	2	\$84.95



Reinforced Cuffed
Spiral Stainless Steel

- LATEX FREE • STERILE • DISPOSABLE •

- Ruschelit® PVC
- Siliconized
- Murphy eye
- Connector is permanently fixed into the tube
- X-ray opaque line
- Graduated depth marks

Item	I.D.	Qty	\$
1-1039-35	3.5 mm	5	\$158.95
1-1039-40	4.0 mm	5	\$158.95
1-1039-45	4.5 mm	5	\$158.95
1-1039-50	5.0 mm	5	\$158.95
1-1039-55	5.5 mm	5	\$158.95
1-1039-60	6.0 mm	5	\$158.95
1-1039-65	6.5 mm	5	\$158.95
1-1039-70	7.0 mm	5	\$158.95
1-1039-75	7.5 mm	5	\$158.95
1-1039-80	8.0 mm	5	\$158.95
1-1039-85	8.5 mm	5	\$158.95
1-1039-90	9.0 mm	5	\$158.95
1-1039-95	9.5 mm	5	\$158.95
1-1039-10	10 mm	5	\$158.95



Laryngoflex Reinforced Cuffed
Firm Curve

- LATEX FREE • STERILE • DISPOSABLE •

- Ruschelit® PVC
- Siliconized
- Stainless steel spiral reinforced
- High volume, low pressure cuff
- X-ray opaque line

Item	I.D.	Qty	\$
1-1211-07	7.0 mm	2	\$228.95
1-1211-08	8.0 mm	2	\$228.95
1-1211-09	9.0 mm	2	\$228.95
1-1211-10	10.0 mm	2	\$228.95



MainlineMedical.com
more great products online



Flexi-Set™ with Stylet
Cuffed & Uncuffed

- LATEX FREE • STERILE • DISPOSABLE •

- Ruschelit® PVC
- Murphy eye
- Black positioning ring
- Tube with stylet inside
- High volume, low pressure cuff on cuffed tube
- X-ray opaque line
- Graduated depth marks

Item	I.D.	Qty	\$
Uncuffed			
1-5065-25	2.5 mm	10	\$50.95
1-5065-30	3.0 mm	10	\$50.95
1-5065-35	3.5 mm	10	\$50.95
1-5065-40	4.0 mm	10	\$50.95
1-5065-45	4.5 mm	10	\$50.95
1-5065-50	5.0 mm	10	\$50.95
Cuffed			
1-5045-50	5.5 mm	10	\$55.95
1-5045-55	6.0 mm	10	\$55.95
1-5045-60	6.5 mm	10	\$55.95
1-5045-65	7.0 mm	10	\$55.95
1-5045-70	7.5 mm	10	\$55.95
1-5045-75	8.0 mm	10	\$55.95
1-5045-80	8.5 mm	10	\$55.95
1-5045-85	9.0 mm	10	\$55.95
1-5045-90	9.5 mm	10	\$55.95



Safety Clear® Plus Cuffed
Oral or Nasal Application

- LATEX FREE • STERILE • DISPOSABLE •

- Ruschelit® PVC
- Murphy eye
- Black positioning ring
- High volume/low pressure cuff
- X-ray opaque line
- Graduated depth marks

Item	I.D.	Qty	\$
1-1208-50	5.0 mm	10	\$25.95
1-1208-55	5.5 mm	10	\$25.95
1-1208-60	6.0 mm	10	\$25.95
1-1208-65	6.5 mm	10	\$25.95
1-1208-70	7.0 mm	10	\$25.95
1-1208-75	7.5 mm	10	\$25.95
1-1208-80	8.0 mm	10	\$25.95
1-1208-85	8.5 mm	10	\$25.95
1-1208-90	9.0 mm	10	\$25.95
1-1208-95	9.5 mm	10	\$25.95
1-1208-10	10 mm	10	\$25.95



Safety Clear® Reinforced Cuffed
Magill Design

- LATEX FREE • STERILE • DISPOSABLE •

- Ruschelit® PVC
- Murphy tip
- Black positioning ring
- X-ray opaque line
- Graduated depth marks

Item	I.D.	Qty	\$
Super Safety			
1-1248-25	2.5 mm	10	\$47.95
1-1248-30	3.0 mm	10	\$47.95
1-1248-35	3.5 mm	10	\$47.95
1-1248-40	4.0 mm	10	\$47.95
1-1248-45	4.5 mm	10	\$47.95
Safety Clear			
1-1120-50	5.0 mm	10	\$25.95
1-1120-55	5.5 mm	10	\$25.95
1-1120-60	6.0 mm	10	\$25.95
1-1120-65	6.5 mm	10	\$25.95
1-1120-70	7.0 mm	10	\$25.95
1-1120-75	7.5 mm	10	\$25.95
1-1120-80	8.0 mm	10	\$25.95
1-1120-85	8.5 mm	10	\$25.95
1-1120-90	9.0 mm	10	\$25.95
1-1120-95	9.5 mm	10	\$25.95
1-1120-10	10 mm	10	\$25.95

smiths medical



AIRCARE™ Uncuffed with Stylet
Oral/Nasal

• LATEX FREE • STERILE • DISPOSABLE •

- Made of transparent PVC
- Murphy eye
- Oral or nasal intubation
- Radiopaque blue line for X-ray visualization

Item	I.D.	Qty	\$
1-1030-30	3.0 mm	10	\$21.95
1-1030-35	3.5 mm	10	\$21.95
1-1030-40	4.0 mm	10	\$21.95
1-1030-45	4.5 mm	10	\$21.95
1-1030-50	5.0 mm	10	\$21.95

smiths medical



AIRCARE™ Uncuffed
Oral/Nasal

• LATEX FREE • STERILE • DISPOSABLE •

- Made of transparent PVC
- Murphy eye
- Oral or nasal intubation
- Radiopaque blue line for X-ray visualization

Item	I.D.	Qty	\$
1-1010-50	5.0 mm	10	\$7.95
1-1010-55	5.5 mm	10	\$7.95
1-1010-60	6.0 mm	10	\$7.95
1-1010-65	6.5 mm	10	\$7.95
1-1010-70	7.0 mm	10	\$7.95
1-1010-75	7.5 mm	10	\$7.95
1-1010-80	8.0 mm	10	\$7.95
1-1010-85	8.5 mm	10	\$7.95
1-1010-90	9.0 mm	10	\$7.95

smiths medical



AIRCARE™ Cuffed with Stylet
Preloaded Stylet

• LATEX FREE • STERILE • DISPOSABLE •

- Made of transparent PVC
- Murphy eye
- 15 mm fitting adapter
- Radiopaque blue line for X-ray visualization

Item	I.D.	Qty	\$
1-1020-50	5.0 mm	10	\$16.95
1-1020-55	5.5 mm	10	\$16.95
1-1020-60	6.0 mm	10	\$16.95
1-1020-65	6.5 mm	10	\$16.95
1-1020-70	7.0 mm	10	\$16.95
1-1020-75	7.5 mm	10	\$16.95
1-1020-80	8.0 mm	10	\$16.95
1-1020-85	8.5 mm	10	\$16.95
1-1020-90	9.0 mm	10	\$16.95

smiths medical



AIRCARE™ Cuffed
Standard Connector

• LATEX FREE • STERILE • DISPOSABLE •

- Made of transparent PVC
- Murphy eye
- 15 mm fitting adapter
- Radiopaque blue line for X-ray visualization

Item	I.D.	Qty	\$
1-1001-50	5.0 mm	10	\$9.95
1-1001-55	5.5 mm	10	\$9.95
1-1001-60	6.0 mm	10	\$9.95
1-1001-65	6.5 mm	10	\$9.95
1-1001-70	7.0 mm	10	\$9.95
1-1001-75	7.5 mm	10	\$9.95
1-1001-80	8.0 mm	10	\$9.95
1-1001-85	8.5 mm	10	\$9.95
1-1001-90	9.0 mm	10	\$9.95

smiths medical



Blue Line Cuffed
Soft-Seal Cuff Provides Patient Comfort & Safety

• LATEX FREE • STERILE • DISPOSABLE •

- Features high volume, low pressure soft-seal profile cuff
- Constructed of flexible, implant tested PVC with radiopaque blue line extending full tube length
- Standard 15 mm ISO connector supplied with each tube

Item	I.D.	Qty	\$
1-9205-55	5.5 mm	20	\$47.95
1-9205-60	6.0 mm	20	\$47.95
1-9205-65	6.5 mm	20	\$47.95
1-9205-70	7.0 mm	20	\$47.95
1-9205-75	7.5 mm	20	\$47.95
1-9205-80	8.0 mm	20	\$47.95
1-9205-85	8.5 mm	20	\$47.95
1-9205-90	9.0 mm	20	\$47.95
1-9205-95	9.5 mm	20	\$47.95

smiths medical



Preformed Oral Cuffed
RAE Tube

• LATEX FREE • STERILE • DISPOSABLE •

- Used for maxillofacial surgery
- Features preformed curve
- Removes or directs breathing circuits away from the operative field
- Standard 15 mm ISO connector supplied with each tube

Item	I.D.	Qty	\$
1-1810-50	5.0 mm	10	\$57.95
1-1810-55	5.5 mm	10	\$57.95
1-1810-60	6.0 mm	10	\$57.95
1-1810-65	6.5 mm	10	\$57.95
1-1810-70	7.0 mm	10	\$57.95
1-1810-75	7.5 mm	10	\$57.95
1-1810-80	8.0 mm	10	\$57.95
1-1810-85	8.5 mm	10	\$57.95
1-1810-90	9.0 mm	10	\$57.95

smiths medical



Preformed Oral Uncuffed
RAE Tube

• LATEX FREE • STERILE • DISPOSABLE •

- Used for maxillofacial surgery
- Features preformed curve
- Removes or directs breathing circuits away from the operative field
- Standard 15 mm ISO connector supplied with each tube

Item	I.D.	Qty	\$
1-1103-00	3.0 mm	10	\$53.95
1-1103-50	3.5 mm	10	\$53.95
1-1104-00	4.0 mm	10	\$53.95
1-1104-50	4.5 mm	10	\$53.95
1-1105-00	5.0 mm	10	\$53.95
1-1106-00	6.0 mm	10	\$53.95
1-1106-50	6.5 mm	10	\$53.95
1-1107-00	7.0 mm	10	\$53.95
1-1107-50	7.5 mm	10	\$53.95

smiths medical



Maxillofacial Cuffed
Extra Soft

• LATEX FREE • STERILE • DISPOSABLE •

- Used for maxillofacial surgery
- Features preformed curve
- Indicated for use in airway management during surgical procedures involving the head, neck and/or mouth

Item	I.D.	Qty	\$
1-1330-60	6.0 mm	10	\$77.95
1-1330-65	6.5 mm	10	\$77.95
1-1330-70	7.0 mm	10	\$77.95
1-1330-75	7.5 mm	10	\$77.95
1-1330-80	8.0 mm	10	\$77.95



VentiSeal™ Oral Cuffed

Double Line Depth Guide

• LATEX FREE • STERILE • DISPOSABLE

- Kink resistant
- Softens at body temperature
- Larger cuff enables even pressure distribution
- Thin walls of cuff reduces abrasive creases and folds
- Smooth material permits gentle conformity to tracheal contours



VentiSeal™ Nasal Cuffed

Kink Resistant

• LATEX FREE • STERILE • DISPOSABLE

- Softens at body temperature
- Double line depth guide
- Larger cuff enables even pressure distribution
- Thin walls of cuff reduces abrasive creases and folds
- Smooth material permits gentle conformity to tracheal contours



Preformed Oral Uncuffed

AGT/RAE Tube

• LATEX FREE • STERILE • DISPOSABLE

- Kink resistant
- High resolution radiopaque line
- Smooth rounded beveled tip
- Optimum size Murphy Eye



Preformed Nasal Uncuffed

AGT/RAE Tube

• LATEX FREE • STERILE • DISPOSABLE

- Kink resistant
- High resolution radiopaque line
- Smooth rounded beveled tip
- Optimum size Murphy Eye

Item	I.D.	Qty	\$
1-9720-50	5.0 mm	10	\$41.95
1-9720-55	5.5 mm	10	\$41.95
1-9720-60	6.0 mm	10	\$41.95
1-9720-65	6.5 mm	10	\$41.95
1-9720-70	7.0 mm	10	\$41.95
1-9720-75	7.5 mm	10	\$41.95
1-9720-80	8.0 mm	10	\$41.95
1-9720-85	8.5 mm	10	\$41.95
1-9720-90	9.0 mm	10	\$41.95

Item	I.D.	Qty	\$
1-9740-60	6.0 mm	10	\$41.95
1-9740-65	6.5 mm	10	\$41.95
1-9740-70	7.0 mm	10	\$41.95
1-9740-75	7.5 mm	10	\$41.95
1-9740-80	8.0 mm	10	\$41.95

Item	I.D.	Qty	\$
1-9620-50	5.0 mm	10	\$40.95
1-9620-55	5.5 mm	10	\$40.95
1-9620-60	6.0 mm	10	\$40.95
1-9620-65	6.5 mm	10	\$40.95
1-9620-70	7.0 mm	10	\$40.95
1-9620-75	7.5 mm	10	\$40.95
1-9620-80	8.0 mm	10	\$40.95
1-9620-85	8.5 mm	10	\$40.95
1-9620-90	9.0 mm	10	\$40.95

Item	I.D.	Qty	\$
1-9640-30	3.0 mm	10	\$40.95
1-9640-35	3.5 mm	10	\$40.95
1-9640-40	4.0 mm	10	\$40.95
1-9640-45	4.5 mm	10	\$40.95
1-9640-50	5.0 mm	10	\$40.95
1-9640-55	5.5 mm	10	\$40.95
1-9640-60	6.0 mm	10	\$40.95
1-9640-65	6.5 mm	10	\$40.95
1-9640-70	7.0 mm	10	\$40.95



Flex-Tip® Nasal Cuffed

Glides Through Airway

• LATEX FREE • STERILE • DISPOSABLE

- Designed to facilitate rapid, non-traumatic intubation
- Unique, patented design has a flexible, curved, centered, tapered distal tip
- Tapered tip designed to flex and slide gently along the airway without catching on tissue

Item	I.D.	Qty	\$
H-PFNC-40	4.0 mm	5	\$23.95
H-PFNC-45	4.5 mm	5	\$23.95
H-PFNC-50	5.0 mm	5	\$23.95
H-PFNC-55	5.5 mm	5	\$23.95
H-PFNC-60	6.0 mm	5	\$23.95
H-PFNC-65	6.5 mm	5	\$23.95
H-PFNC-70	7.0 mm	5	\$23.95
H-PFNC-75	7.5 mm	5	\$23.95
H-PFNC-80	8.0 mm	5	\$23.95
H-PFNC-85	8.5 mm	5	\$23.95
H-PFNC-90	9.0 mm	5	\$23.95



Flex-Tip® Nasal Uncuffed

Helps Prevent Airway Trauma

• LATEX FREE • STERILE • DISPOSABLE

- Designed to facilitate rapid, non-traumatic intubation
- Unique, patented design has a flexible, curved, centered, tapered distal tip
- Tapered tip designed to flex and slide gently along the airway without catching on tissue

Item	I.D.	Qty	\$
H-PFNU-30	3.0 mm	5	\$23.95
H-PFNU-35	3.5 mm	5	\$23.95
H-PFNU-40	4.0 mm	5	\$23.95
H-PFNU-45	4.5 mm	5	\$23.95
H-PFNU-50	5.0 mm	5	\$23.95
H-PFNU-55	5.5 mm	5	\$23.95
H-PFNU-60	6.0 mm	5	\$23.95
H-PFNU-65	6.5 mm	5	\$23.95
H-PFNU-70	7.0 mm	10	\$23.95



Flex-Tip® Oral Cuffed

Centered Tip Design

• LATEX FREE • STERILE • DISPOSABLE

- Designed to facilitate rapid, non-traumatic intubation
- Unique, patented design has a flexible, curved, centered, tapered distal tip
- Tapered tip designed to flex and slide gently along the airway without catching on tissue

Item	I.D.	Qty	\$
H-PFOC-40	4.0 mm	10	\$23.95
H-PFOC-45	4.5 mm	10	\$23.95
H-PFOC-50	5.0 mm	10	\$23.95
H-PFOC-55	5.5 mm	10	\$23.95
H-PFOC-60	6.0 mm	10	\$23.95
H-PFOC-65	6.5 mm	10	\$23.95
H-PFOC-70	7.0 mm	10	\$23.95
H-PFOC-75	7.5 mm	10	\$23.95
H-PFOC-80	8.0 mm	10	\$23.95
H-PFOC-85	8.5 mm	10	\$23.95
H-PFOC-90	9.0 mm	10	\$23.95



Flex-Tip® Oral Uncuffed

Help Avoid Airway Collisions

• LATEX FREE • STERILE • DISPOSABLE

- Designed to facilitate rapid, non-traumatic intubation
- Unique, patented design has a flexible, curved, centered, tapered distal tip
- Tapered tip designed to flex and slide gently along the airway without catching on tissue

Item	I.D.	Qty	\$
H-PFOU-30	3.0 mm	10	\$23.95
H-PFOU-35	3.5 mm	10	\$23.95
H-PFOU-40	4.0 mm	10	\$23.95
H-PFOU-45	4.5 mm	10	\$23.95
H-PFOU-50	5.0 mm	10	\$23.95
H-PFOU-55	5.5 mm	10	\$23.95
H-PFOU-60	6.0 mm	10	\$23.95
H-PFOU-65	6.5 mm	10	\$23.95
H-PFOU-70	7.0 mm	10	\$23.95
H-PFOU-75	7.5 mm	10	\$23.95
H-PFOU-80	8.0 mm	10	\$23.95
H-PFOU-85	8.5 mm	10	\$23.95
H-PFOU-90	9.0 mm	10	\$23.95



Preformed Nasal Cuffed (AGT) (RAE) Type

• LATEX FREE • STERILE • DISPOSABLE •

- Directs tube over patient's forehead, reducing pressure on nares
- Murphy eye
- Barrel cuff profile minimizes capillary constriction within the trachea
- High volume, low pressure cuff provides excellent tracheal wall seal
- Smooth tube tip to minimize trauma during intubation
- Standard 15 mm connector

Item	I.D.	Qty	\$
1-7323-40	4.0 mm	10	\$49.95
1-7323-45	4.5 mm	10	\$49.95
1-7323-50	5.0 mm	10	\$49.95
1-7323-55	5.5 mm	10	\$49.95
1-7323-60	6.0 mm	10	\$49.95
1-7323-65	6.5 mm	10	\$49.95
1-7323-70	7.0 mm	10	\$49.95
1-7323-75	7.5 mm	10	\$49.95
1-7323-80	8.0 mm	10	\$49.95

Preformed Nasal Uncuffed (AGT) (RAE) Type

• LATEX FREE • STERILE • DISPOSABLE •

- Directs tube over patient's forehead, reducing pressure on nares
- Murphy eye
- Smooth tube tip to minimize trauma during intubation
- Standard 15 mm connector

Item	I.D.	Qty	\$
1-7322-30	3.0 mm	10	\$38.95
1-7322-35	3.5 mm	10	\$38.95
1-7322-40	4.0 mm	10	\$38.95
1-7322-45	4.5 mm	10	\$38.95
1-7322-50	5.0 mm	10	\$38.95
1-7322-55	5.5 mm	10	\$38.95

Preformed Nasal Cuffed (AGT) (RAE) Type

• LATEX FREE • STERILE • DISPOSABLE •

- Ruschelit PVC
- Murphy eye
- High volume, low pressure cuff
- X-ray opaque line
- Graduated depth marks
- For improved surgical access
- Designed to reduce kinking with preformed curvature

Item	I.D.	Qty	\$
1-1178-35	3.5 mm	10	\$72.95
1-1178-40	4.0 mm	10	\$72.95
1-1178-45	4.5 mm	10	\$72.95
1-1178-50	5.0 mm	10	\$72.95
1-1178-55	5.5 mm	10	\$72.95
1-1178-60	6.0 mm	10	\$72.95
1-1178-65	6.5 mm	10	\$72.95
1-1178-70	7.0 mm	10	\$72.95
1-1178-75	7.5 mm	10	\$72.95
1-1178-80	8.0 mm	10	\$72.95

Preformed Nasal Uncuffed (AGT) (RAE) Type

• LATEX FREE • STERILE • DISPOSABLE •

- Ruschelit PVC
- Two staggered eyes
- Marked with recommended tube size for patient age
- X-ray opaque line
- Graduated depth marks
- For improved surgical access
- Designed to reduce kinking with preformed curvature

Item	I.D.	Qty	\$
1-0091-30	3.0 mm	10	\$47.95
1-0091-40	3.5 mm	10	\$47.95
1-0091-45	4.0 mm	10	\$47.95
1-0091-50	4.5 mm	10	\$47.95
1-0091-55	5.0 mm	10	\$47.95
1-0091-60	5.5 mm	10	\$47.95
1-0091-65	6.0 mm	10	\$47.95

Preformed Oral Cuffed (AGT) (RAE) Type

• LATEX FREE • STERILE • DISPOSABLE •

- Directs tube downward to rest on patient's chin
- Murphy eye
- Barrel cuff profile minimizes capillary constriction within the trachea
- High volume, low pressure cuff provides excellent tracheal wall seal
- Smooth tube tip to minimize trauma during intubation
- Standard 15 mm connector

Item	I.D.	Qty	\$
1-7321-40	4.0 mm	10	\$49.95
1-7321-45	4.5 mm	10	\$49.95
1-7321-50	5.0 mm	10	\$49.95
1-7321-55	5.5 mm	10	\$49.95
1-7321-60	6.0 mm	10	\$49.95
1-7321-65	6.5 mm	10	\$49.95
1-7321-70	7.0 mm	10	\$49.95
1-7321-75	7.5 mm	10	\$49.95
1-7321-80	8.0 mm	10	\$49.95
1-7321-85	8.5 mm	10	\$49.95
1-7321-90	9.0 mm	10	\$49.95

Preformed Oral Uncuffed (AGT) (RAE) Type

• LATEX FREE • STERILE • DISPOSABLE •

- Directs tube downward to rest on patient's chin
- Murphy eye
- Smooth tube tip to minimize trauma during intubation
- Standard 15 mm connector

Item	I.D.	Qty	\$
1-7320-30	3.0 mm	10	\$38.95
1-7320-35	3.5 mm	10	\$38.95
1-7320-40	4.0 mm	10	\$38.95
1-7320-45	4.5 mm	10	\$38.95
1-7320-50	5.0 mm	10	\$38.95
1-7320-55	5.5 mm	10	\$38.95

Preformed Oral Cuffed (AGT) (RAE) Type

• LATEX FREE • STERILE • DISPOSABLE •

- Ruschelit PVC
- Murphy eye
- High volume, low pressure cuff
- X-ray opaque line
- Graduated depth marks
- For improved surgical access
- Designed to reduce kinking with preformed curvature

Item	I.D.	Qty	\$
1-1117-35	3.5 mm	10	\$72.95
1-1117-40	4.0 mm	10	\$72.95
1-1117-45	4.5 mm	10	\$72.95
1-1117-50	5.0 mm	10	\$72.95
1-1117-55	5.5 mm	10	\$72.95
1-1117-60	6.0 mm	10	\$72.95
1-1117-65	6.5 mm	10	\$72.95
1-1117-70	7.0 mm	10	\$72.95
1-1117-75	7.5 mm	10	\$72.95
1-1117-80	8.0 mm	10	\$72.95
1-1117-85	8.5 mm	10	\$72.95
1-1117-90	9.0 mm	10	\$72.95

Preformed Oral Uncuffed (AGT) (RAE) Type

• LATEX FREE • STERILE • DISPOSABLE •

- Ruschelit PVC
- Two staggered eyes
- Marked with recommended tube size for patient age
- X-ray opaque line
- Graduated depth marks
- For improved surgical access
- Designed to reduce kinking with preformed curvature

Item	I.D.	Qty	\$
1-0018-30	3.0 mm	10	\$47.95
1-0018-35	3.5 mm	10	\$47.95
1-0018-40	4.0 mm	10	\$47.95
1-0018-45	4.5 mm	10	\$47.95
1-0018-50	5.0 mm	10	\$47.95
1-0018-55	5.5 mm	10	\$47.95
1-0018-60	6.0 mm	10	\$47.95
1-0018-65	6.5 mm	10	\$47.95
1-0018-70	7.0 mm	10	\$47.95



**Carlens Tube
Left Bronchus**
With Carina Hook

• LATEX FREE • STERILE • DISPOSABLE

- Ruschelit PVC
- Color coded for easy identification of ports, balloons and 15 mm connectors
- High volume/low pressure cuff
- Stylet and suction catheters included
- X-ray opaque line
- Graduated markings
- Swivel connector with self-sealing ports

Item	Size	Qty	\$
1-1644-35	35 Fr	1	\$116.95
1-1644-37	37 Fr	1	\$116.95
1-1644-39	39 Fr	1	\$116.95
1-1644-41	41 Fr	1	\$116.95



**Robertshaw Tube
Left Bronchus**
X-Ray Opaque Line

• LATEX FREE • STERILE • DISPOSABLE

- Ruschelit PVC
- Color coded for easy identification of ports, balloons and 15 mm connectors
- High volume/low pressure cuff
- Stylet and suction catheters included
- Graduated markings
- Swivel connector with self-sealing port

Item	Size	Qty	\$
1-1610-26	26 Fr	1	\$100.95
1-1610-28	28 Fr	1	\$100.95
1-1610-35	35 Fr	1	\$100.95
1-1610-37	37 Fr	1	\$100.95
1-1610-39	39 Fr	1	\$100.95
1-1610-41	41 Fr	1	\$100.95



**Robertshaw Tube
Right Bronchus**
High Volume/Low Pressure Cuff

• LATEX FREE • STERILE • DISPOSABLE

- Ruschelit PVC
- Color coded for easy identification of ports, balloons and 15 mm connectors
- Stylet and suction catheters included
- X-ray opaque line
- Graduated markings
- Swivel connectors with self-sealing ports

Item	Size	Qty	\$
1-1620-26	26 Fr	1	\$108.95
1-1620-28	28 Fr	1	\$108.95
1-1620-35	35 Fr	1	\$108.95
1-1620-37	37 Fr	1	\$108.95
1-1620-39	39 Fr	1	\$108.95
1-1620-41	41 Fr	1	\$108.95



**Dr. White Tube
Right Bronchus**
With Carina Hook

• LATEX FREE • STERILE • DISPOSABLE

- Ruschelit PVC
- Color coded for easy identification of ports, balloons and 15 mm connectors
- High volume/low pressure cuff
- Stylet and suction catheters included
- X-ray opaque line
- Graduated markings
- Swivel connector with self-sealing port

Item	Size	Qty	\$
1-1634-35	35 Fr	1	\$126.95
1-1634-37	37 Fr	1	\$126.95
1-1634-39	39 Fr	1	\$126.95
1-1634-41	41 Fr	1	\$126.95



Hy-Tape®
The Original Pink Tape®

• LATEX FREE •

- Water-resistant, washable tape suited for use with ET tubes
- Conforms to body contours and adheres firmly to oily or hairy skin
- Will not break down over time allowing skin to remain intact, promoting faster healing and reduce infection
- Individually wrapped rolls available in four widths: 0.5", 1", 1.5", 2"

Item	Description	Qty	\$
9-0075-05	0.5" x 5 yd	36	\$64.95
9-0075-10	1" x 5 yd	36	\$133.95
9-0075-15	1.5" x 5 yd	36	\$198.95
9-0075-20	2" x 5 yd	36	\$260.95



MainlineMedical.com
more great products online



**Robertshaw Tube
Left & Right Bronchus**
Graduated Depth Marks

• LATEX FREE • STERILE • DISPOSABLE

- Color coded clear (tracheal) and blue (bronchial) for easy differentiation of appropriate lumen, pilot balloon and cuff
- Soft PVC
- High volume, low pressure cuff
- Radiopaque strip
- Includes a 15 mm Y-connector

Item	Size	Qty	\$
Left Bronchus			
1-7370-35	35 Fr	1	\$59.95
1-7370-37	37 Fr	1	\$59.95
1-7370-39	39 Fr	1	\$59.95
1-7370-41	41 Fr	1	\$59.95
Right Bronchus			
1-7371-35	35 Fr	1	\$64.95
1-7371-37	37 Fr	1	\$64.95
1-7371-39	39 Fr	1	\$64.95
1-7371-41	41 Fr	1	\$64.95



**Double Lumen
Left & Right Bronchus**
High Volume/Low Pressure Cuff

• LATEX FREE • STERILE • DISPOSABLE

- Facilitates easier and faster endobronchial intubation
- Conveniently packaged assembled
- Clampless system uses valves to easily isolate one lung

Item	Size	Qty	\$
Left Bronchus			
H-PSTDL-28-1	28 Fr	1	\$51.95
H-PSTDL-32-1	32 Fr	1	\$51.95
H-PSTDL-35-1	35 Fr	1	\$51.95
H-PSTDL-37-1	37 Fr	1	\$51.95
H-PSTDL-39-1	39 Fr	1	\$51.95
H-PSTDL-41-1	41 Fr	1	\$51.95
Right Bronchus			
H-PSTDR-28-1	28 Fr	1	\$51.95
H-PSTDR-32-1	32 Fr	1	\$51.95
H-PSTDR-35-1	35 Fr	1	\$51.95
H-PSTDR-37-1	37 Fr	1	\$51.95
H-PSTDR-39-1	39 Fr	1	\$51.95
H-PSTDR-41-1	41 Fr	1	\$51.95

smiths medical



Blue Line Left & Right Bronchus Redesigned Stylet

• LATEX FREE • STERILE • DISPOSABLE •

- Extension tubes and pilot balloons imprinted with tracheal (clear) or bronchial (blue) to differentiate the appropriate lumen and cuff
- Thermosensitive, clear PVC
- Color-coded extension tubes, pilot balloons and bronchoscopes along with suction catheter caps
- Resistant to cuff tears
- Less complex cap design
- Softer, straighter tube

Item	Size	Qty	\$
Left Bronchus			
1-0193-28	28 Fr	1	\$64.95
1-0193-32	32 Fr	1	\$64.95
1-0193-35	35 Fr	1	\$64.95
1-0193-37	37 Fr	1	\$64.95
1-0193-39	39 Fr	1	\$64.95
1-0193-41	41 Fr	1	\$64.95
Right Bronchus			
1-0194-28	28 Fr	1	\$64.95
1-0194-32	32 Fr	1	\$64.95
1-0194-35	35 Fr	1	\$64.95
1-0194-37	37 Fr	1	\$64.95
1-0194-39	39 Fr	1	\$64.95
1-0194-41	41 Fr	1	\$64.95

SunMed



Tracheostomy Tube Uncuffed

• LATEX FREE • STERILE • DISPOSABLE •

- Obturator and tube clearly marked
- 15 mm connector swivel adapter
- Soft PVC
- Secure neck band retainer
- Comfortable cushion neck band
- Radiopaque strip embedded for exact location of tube

Item	I.D.	Qty	\$
1-7390-30	3.0 mm	10	\$91.95
1-7390-35	3.5 mm	10	\$91.95
1-7390-40	4.0 mm	10	\$91.95
1-7390-45	4.5 mm	10	\$91.95
1-7390-50	5.0 mm	10	\$91.95

MainlineMedical.com
more great products online

SunMed



Tracheostomy Tube Cuffed

• LATEX FREE • STERILE • DISPOSABLE •

- Obturator and tube clearly marked
- 15 mm connector swivel adapter
- Soft PVC
- Secure neck band retainer
- Comfortable cushion neck band
- Radiopaque strip embedded for exact location of tube
- Low pressure cuff

Item	I.D.	Qty	\$
1-7393-50	3.0 mm	10	\$96.95
1-7393-55	3.5 mm	10	\$96.95
1-7393-60	4.0 mm	10	\$96.95
1-7393-65	4.5 mm	10	\$96.95
1-7393-70	5.0 mm	10	\$96.95
1-7393-75	7.5 mm	10	\$96.95
1-7393-80	8.0 mm	10	\$96.95
1-7393-85	8.5 mm	10	\$96.95
1-7393-90	9.0 mm	10	\$96.95
1-7393-95	9.5 mm	10	\$96.95
1-7393-10	10 mm	10	\$96.95

LockTite™
Secure ET Tubes Without Adhesive Tape

• LATEX FREE • DISPOSABLE •

- Ideal for use on patients with facial burns, severe irritation, beards or long-term sedated patients
- Designed with hypo-allergenic materials for fragile skin and helps minimize skin breakdown
- Features superior holding power to ensure ET tube stability and the prevention of inadvertent extubation
- Secures around patient's neck with Velcro band; includes a zip tie to steady placement and yet can be repositioned
- One size for pediatric through adult patients (min. 4 mm ET tubes)
- Works with both oral and nasal ET tubes

Item	Description	Qty	\$
3-0056-09	LockTite	50	\$244.95



BB Medical Technologies
www.bbmedical.com

ET Tape™ & ET Tape II™
Minimizes Inadvertent Extubations

• LATEX FREE • DISPOSABLE •

- Pre-cut ET tube adhesive tape made of non-irritating foam
- Designed with latex free, hypo-allergenic materials that protect the skin
- Features superior holding power to ensure ET tube stability and the prevention of inadvertent extubation
- Adhesive skin prep is included to help protect against skin breakdown and irritation
- One size for pediatric through adult patients (min. 4 mm ET tubes)
- Works with both oral and nasal ET tubes

Item	Description	Qty	\$
3-0056-02	ET Tape for Short Term Use	100	\$490.95
3-0056-01	ET Tape II for Long Term Use	100	\$460.95

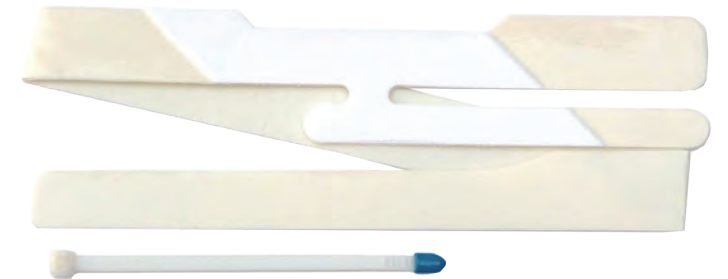

BB Medical Technologies
www.bbmedical.com

ET Tube Holder
Mouth Cushion Comfortably Stabilizes ET Tube

• LATEX FREE • DISPOSABLE •

- Keeps ET tube in place without applying tape to patient's face
- Supplied with cloth tie, safety pin and soft foam mouth cushion
- Replacement mouth cushions sold separately
- Individually wrapped

Item	Description	Qty	\$
9-3042-65	ET Tube Holder	10	\$29.95
9-3042-66	Replacement Mouth Cushions	50	\$33.95



HUDSON RCI



air-Q® Laryngeal Mask
The Intubating Airway that Creates an Airway

- LATEX FREE • STERILE • DISPOSABLE •
- Epiglottis elevator opens the airway and a ramp guides the ET tube placement providing unparalleled airway access
- Designed by clinicians to improve airway placement and patient safety
- Removable connector and large ID
- Anatomical bowl and built-up mask heel improves placement and seal
- Safety hole provides gas exchange if occlusion occurs
- Color coded removable cap

Item	Description	Color	Size	Qty	\$
10-3010	< 7 kg	Blue	1	10	\$101.95
10-3015	7-17 kg	Green	1.5	10	\$101.95
10-3020	17-30 kg	Orange	2	10	\$101.95
10-3025	30-50 kg	Yellow	2.5	10	\$101.95
10-3035	50-70 kg	Red	3.5	10	\$101.95
10-3045	70-100 kg	Purple	4.5	10	\$101.95



air-Q® Reusable Laryngeal Mask
Effectively Opens Airway and Guides ET Tube Insertion

- LATEX FREE • STERILE • REUSABLE •
- Epiglottis elevator opens the airway and a ramp guides the ET tube placement providing unparalleled airway access
- Designed by clinicians to improve airway placement and patient safety
- Removable connector and large ID
- Anatomical bowl and built-up mask heel improves placement and seal
- Safety hole provides gas exchange if occlusion occurs
- Color coded removable cap

Item	Description	Color	Size	Qty	\$
10-1001	<4 kg	Pink	0.5	1	\$198.95
10-1010	4-7 kg	Blue	1	1	\$198.95
10-1015	7-17 kg	Green	1.5	1	\$164.95
10-1020	17-30 kg	Orange	2	1	\$164.95
10-1025	30-50 kg	Yellow	2.5	1	\$164.95
10-1035	50-70 kg	Red	3.5	1	\$164.95
10-1045	70-100 kg	Purple	4.5	1	\$164.95



Aura40™ Reusable LMA
Straight or Curved Silicone Airways

- LATEX FREE • REUSABLE •
- Color coded pilot balloon identifies mask sizes
- Steam autoclavable version of Ambu's popular AuraOnce™
- Clearly marked guidelines for easy insertion
- Curved option ensures patient's head remains in a neutral position
- Curved option has a universal check valve
- Maximum intra-cuff pressure 60 cm H₂O for all sizes

Curved Aura40 LMA

Item	Description	Size	Max Cuff	Qty	\$
1-2256-10	Neonate, < 5 kg	1.0	4.0 mL	1	\$174.95
1-2256-15	Infant, 5-10 kg	1.5	7.0 mL	1	\$174.95
1-2256-20	Infant/Child, 10-20 kg	2.0	10.0 mL	1	\$174.95
1-2256-25	Child, 20-30 kg	2.5	14.0 mL	1	\$174.95
1-2256-30	Child, 30-50 kg	3.0	20.0 mL	1	\$174.95
1-2256-40	Adult, 50-70 kg	4.0	30.0 mL	1	\$174.95
1-2256-50	Adult, 70-100 kg	5.0	40.0 mL	1	\$174.95
1-2256-60	Adult, 100 kg & Over	6.0	50.0 mL	1	\$174.95

Straight Aura40 LMA

Item	Description	Size	Max Cuff	Qty	\$
1-2254-10	Neonate, < 5 kg	1.0	4.0 mL	1	\$174.95
1-2254-15	Infant, 5-10 kg	1.5	7.0 mL	1	\$174.95
1-2254-20	Infant/Child, 10-20 kg	2.0	10.0 mL	1	\$174.95
1-2254-25	Child, 20-30 kg	2.5	14.0 mL	1	\$174.95
1-2254-30	Child, 30-50 kg	3.0	20.0 mL	1	\$174.95
1-2254-40	Adult, 50-70 kg	4.0	30.0 mL	1	\$174.95
1-2254-50	Adult, 70-100 kg	5.0	40.0 mL	1	\$174.95
1-2254-60	Adult, 100 kg & Over	6.0	50.0 mL	1	\$174.95

LarySeal™ Multiple Reusable LMA

Use Up to 40 Times

- LATEX FREE • REUSABLE •
- Color-coded pilot balloon promotes quick, accurate size selection
- Constructed of medical-grade silicone
- Autoclavable; can be used up to 40 times
- Highly elastic silicone enables cuff to form to the contour of the oropharyngeal anatomy, creating a secure seal
- Pilot balloon indicates cuff pressure



Item	Description	Size	Max Cuff	Qty	\$
1-9438-10	White, < 5 kg	1.0	4.0 mL	10	\$1,749.95
1-9438-15	Blue, 5-10 kg	1.5	7.0 mL	10	\$1,749.95
1-9438-20	Lt. Green, 10-20 kg	2.0	10.0 mL	10	\$1,749.95
1-9438-25	Green, 20-30 kg	2.5	14.0 mL	10	\$1,749.95
1-9438-30	Orange, 30-50 kg	3.0	20.0 mL	10	\$1,749.95
1-9438-40	Red, 50-70 kg	4.0	30.0 mL	10	\$1,749.95
1-9438-50	Yellow, 70-100 kg	5.0	40.0 mL	10	\$1,749.95
1-8940-01	LarySeal Cuff Inflator	-	-	10	\$14.95



AuraStraight™
MRI Conditional LMA

• LATEX FREE • STERILE • DISPOSABLE •

- Clearly marked guidelines for easy insertion, cuff inflation volume and patient weight on pilot balloon
- Universal 15 mm male connector (ISO)
- Maximum intra-cuff pressure: 60 cm H₂O



Item	Description	Size	Max Cuff	Qty	\$
1-2252-01	Infant, < 5 kg	1.0	4 mL	10	\$79.95
1-2252-15	Infant, 5-10 kg	1.5	7 mL	10	\$79.95
1-2252-02	Pediatric, 10-20 kg	2.0	10 mL	10	\$79.95
1-2252-25	Pediatric, 20-30 kg	2.5	14 mL	10	\$79.95
1-2252-03	Adult, 30-50 kg	3.0	20 mL	10	\$79.95
1-2252-04	Adult, 50-70 kg	4.0	30 mL	10	\$79.95
1-2252-05	Adult, 70-100 kg	5.0	40 mL	10	\$79.95
1-2252-06	Adult, >100 kg	6.0	50 mL	10	\$79.95



LarySeal™ Clear
Disposable, Cost Effective LMA

• LATEX FREE • STERILE • DISPOSABLE •

- Medical grade PVC
- Crush resistant
- 15 mm universal connector
- Color-coding feature promotes quick, accurate size selection

Item	Description	Size	Max Cuff	Qty	\$
1-3894-10	LarySeal Clear, < 5 kg	1.0	4.0 mL	10	\$78.95
1-3894-15	LarySeal Clear, 5-10 kg	1.5	7.0 mL	10	\$78.95
1-3894-20	LarySeal Clear, 10-20 kg	2.0	10.0 mL	10	\$78.95
1-3894-25	LarySeal Clear, 20-30 kg	2.5	14.0 mL	10	\$78.95
1-3894-30	LarySeal Clear, 30-50 kg	3.0	20.0 mL	10	\$78.95
1-3894-40	LarySeal Clear, 50-70 kg	4.0	30.0 mL	10	\$78.95
1-3894-50	LarySeal Clear, 70-100 kg	5.0	40.0 mL	10	\$78.95
1-8940-01	LarySeal Cuff Inflator	--	--	10	\$14.95



LMA Unique™ Airway
The Original Single Use Airway

• LATEX FREE • STERILE • DISPOSABLE •

- Used on over 200 million patients worldwide
- Reliable, proven performance with millions of safe users
- Simple, easy insertion
- Minimally invasive airway
- Proven ventilation in rescue situations

Item	Description	Size	Max Cuff	Qty	\$
1-2501-01	Infant, < 5 kg	1.0	4 mL	10	\$206.95
1-2501-15	Infant, 5-10 kg	1.5	7 mL	10	\$206.95
1-2501-02	Pediatric, 10-20 kg	2.0	10 mL	10	\$206.95
1-2501-25	Pediatric, 20-30 kg	2.5	14 mL	10	\$206.95
1-2501-03	Adult, 30-50 kg	3.0	20 mL	10	\$206.95
1-2501-04	Adult, 50-70 kg	4.0	30 mL	10	\$206.95
1-2501-05	Adult, 70-100 kg	5.0	40 mL	10	\$206.95



AuraOnce™ Airway
Single Molded Unit Airway Tube & Cuff

• LATEX FREE • STERILE • DISPOSABLE •

- Flexible at the cuff and rigid at the connector for easy insertion and removal
- Reinforced tip will not bend during insertion, for correct placement
- Extra soft 0.4 mm cuff ensures proper seal and least possible intra-cuff pressure
- Maximum intra-cuff pressure: 60 cm H₂O

Item	Description	Size	Max Cuff	Qty	\$
1-2250-10	Infant, < 5 kg	1.0	4 mL	10	\$79.95
1-2250-15	Infant, 5-10 kg	1.5	7 mL	10	\$79.95
1-2250-20	Pediatric, 10-20 kg	2.0	10 mL	10	\$79.95
1-2250-25	Pediatric, 20-30 kg	2.5	14 mL	10	\$79.95
1-2250-03	Adult, 30-50 kg	3.0	20 mL	10	\$79.95
1-2250-04	Adult, 50-70 kg	4.0	30 mL	10	\$79.95
1-2250-05	Adult, 70-100 kg	5.0	40 mL	10	\$79.95
1-2250-06	Adult, >100 kg	6.0	50 mL	10	\$79.95



AuraGain™ Airway with Gastric Access
Anatomically Curved SGA

• LATEX FREE • STERILE • DISPOSABLE •

- Proven seal pressure up to 40 cm H₂O
- Integrated gastric access and intubation capability
- Designed for patient safety and airway management efficiency

Item	Description	Size	Max Cuff	Qty	\$
1-2258-10	Infant, < 5 kg	1.0	4 mL	10	\$112.95
1-2258-15	Infant, 5-10 kg	1.5	7 mL	10	\$112.95
1-2258-20	Pediatric, 10-20 kg	2.0	10 mL	10	\$112.95
1-2258-25	Pediatric, 20-30 kg	2.5	14 mL	10	\$112.95
1-2258-30	Adult, 30-50 kg	3.0	20 mL	10	\$112.95
1-2258-40	Adult, 50-70 kg	4.0	30 mL	10	\$112.95
1-2258-50	Adult, 70-100 kg	5.0	40 mL	10	\$112.95



LMA Supreme™ Airway
Integrated Drain Tube

• LATEX FREE • STERILE • DISPOSABLE •

- First and only single use laryngeal mask with built-in drain tube
- Designed to channel gastric fluid away from the airway
- Drain may also be use to actively suction the stomach
- Improved curve for easy insertion
- Integral bite block
- Reinforced tip and molded distal cuff resists folding

Item	Description	Size	Max Cuff	Qty	\$
1-2281-01	Neonate/Infant, < 5 kg	1.0	5 mL	10	\$520.95
1-2281-15	Infant, 5-10 kg	1.5	8 mL	10	\$287.95
1-2281-02	Child, 10-20 kg	2.0	12 mL	10	\$520.95
1-2281-25	Child, 20-30 kg	2.5	20 mL	10	\$382.95
1-2281-03	Child, 30-50 kg	3.0	30 mL	10	\$382.95
1-2281-04	Adult, 50-70 kg	4.0	45 mL	10	\$382.95
1-2281-05	Adult, 70-100 kg	5.0	45 mL	10	\$382.95





Aura-I™ Airway

Preformed Shape Follows Airway Anatomy

• LATEX FREE • STERILE • DISPOSABLE •

- Soft, rounded curve ensures fast and easy placement and guarantees long-term performance with minimal patient trauma
- Navigation marks for guiding fiber/video scope
- Pilot balloon identifies mask size and provides precise tactile indication of degree of inflation
- Bite resistance in the connector block prevents occlusions

Item	Description	Size	Max Cuff	Qty	\$
1-2253-01	Infant, < 5 kg	1.0	4 mL	10	\$95.95
1-2253-15	Infant, 5-10 kg	1.5	7 mL	10	\$95.95
1-2253-02	Pediatric, 10-20 kg	2.0	10 mL	10	\$95.95
1-2253-25	Pediatric, 20-30 kg	2.5	14 mL	10	\$95.95
1-2253-03	Adult, 30-50 kg	3.0	20 mL	10	\$95.95
1-2253-04	Adult, 50-70 kg	4.0	30 mL	10	\$95.95
1-2253-05	Adult, 70-100 kg	5.0	40 mL	10	\$95.95
1-2253-06	Adult, >100 kg	6.0	50 mL	10	\$95.95



AuraFlex™ Reinforced Airway

Eliminates Risk of Airway Tube Occlusion

• LATEX FREE • STERILE • DISPOSABLE •

- Kink-free, wire-reinforced tube
- Highly flexible tubing enables positioning away from the surgical field without compromising seal
- Integrated pilot tube reduces risk of cutting pilot tube during surgery
- Maximum intra-cuff pressure 60 cm H₂O for all sizes

Item	Description	Size	Max Cuff	Qty	\$
1-2251-20	Pediatric, 10-20 kg	2.0	10 mL	10	\$174.95
1-2251-25	Pediatric, 20-30 kg	2.5	14 mL	10	\$174.95
1-2251-30	Adult, 30-50 kg	3.0	20 mL	10	\$174.95
1-2251-40	Adult, 50-70 kg	4.0	30 mL	10	\$174.95
1-2251-50	Adult, 70-100 kg	5.0	40 mL	10	\$174.95
1-2251-60	Adult, >100 kg	6.0	50 mL	10	\$174.95

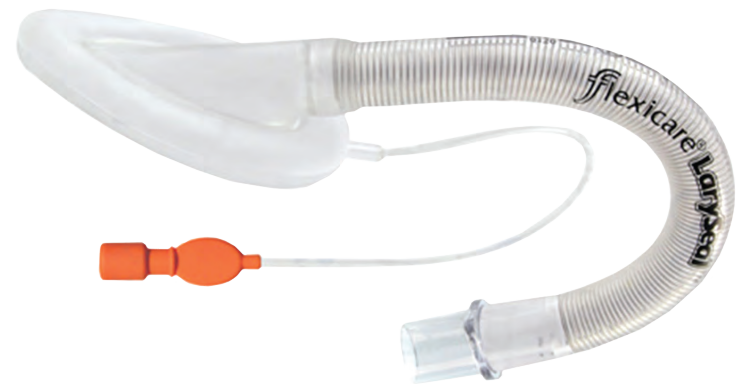

LarySeal™ Flexi LMA

Designed for Use in Ophthalmic, ENT & Dental Surgeries

• LATEX FREE • STERILE • DISPOSABLE •

- Flexible tubing reinforced with kink-resistant wire
- Medical grade PVC
- Universal 15 mm connector
- Color coded pilot balloon for quick size identification

Item	Description	Size	Qty	\$
1-8945-20	Pediatric, 10-20 kg	2.0	10	\$174.95
1-8945-25	Pediatric, 20-30 kg	2.5	10	\$174.95
1-8945-30	Adult, 30-50 kg	3.0	10	\$174.95
1-8945-40	Adult, 50-70 kg	4.0	10	\$174.95
1-8945-50	Adult, 70-100 kg	5.0	10	\$174.95
1-8940-01	LarySeal Cuff Inflator	--	10	\$14.95



Solus™ Standard Airway

Ideal for Emergency & Anesthesia Applications

• LATEX FREE • STERILE • DISPOSABLE •

- Low friction material helps reduce drag during insertion/extraction
- Integrated inflation line helps prevent damage during use
- High quality valve ensures performance integrity of cuff
- Classic cuff shape for reliable, consistent use

Item	Description	Size	Qty	\$
1-8030-01	Neonate	1.0	20	\$129.95
1-8030-15	Infant	1.5	20	\$129.95
1-8030-02	Small Pediatric	2.0	20	\$129.95
1-8030-25	Large Pediatric	2.5	20	\$129.95
1-8030-03	Small Adult	3.0	20	\$129.95
1-8030-04	Medium Adult	4.0	20	\$129.95
1-8030-05	Large Adult	5.0	20	\$129.95



Gastro-Laryngeal Tube

Maintain Airway During GED Procedures

• LATEX FREE • REUSABLE •

- Obtain and maintain control of airway potency during complex gastrointestinal endoscope procedures
- Suitable for adults under deep sedation or general anesthesia
- Can be used with either spontaneous breathing or assisted ventilation
- Autoclavable
- Coated to avoid friction and promote smoother placement
- Fits duodenoscopes with max 13.8 mm O.D.
- Silicone

Item	Description	Qty	\$
4-3290-04	Gastro-Laryngeal Tube	1	\$270.95



VBM Medical Inc.

LarySeal™ Blue LMA

Surface Finish Helps Secure Airway

• LATEX FREE • STERILE • DISPOSABLE •

- Crush resistant
- Silicone matte surface finish reduces the risk of movement and cuff dislocation
- Thin-walled pilot balloon indicates the inflation of the cuff
- Color-coded pilot balloon feature promotes quick, accurate size selection

Item	Description	Size	Qty	\$
1-8942-10	White, < 5 kg	1.0	10	\$124.95
1-8942-15	Blue, 5-10 kg	1.5	10	\$124.95
1-8942-20	Lt. Green, 10-20 kg	2.0	10	\$124.95
1-8942-25	Green, 20-30 kg	2.5	10	\$124.95
1-8942-30	Orange, 30-50 kg	3.0	10	\$124.95
1-8942-40	Red, 50-70 kg	4.0	10	\$124.95
1-8942-50	Yellow, 70-100 kg	5.0	10	\$124.95





Allion Tube Bender

Helps Control Tip of the Endotracheal Tube

• LATEX FREE • REUSABLE •

- Improves nasotracheal intubation by easing the endotracheal tube across the vocal cords
- Bends the tube tip down to conform with the direction of the trachea
- Stainless steel
- 100% autoclavable

Item	Description	Qty	\$
9-3021-00	Allion Tube Bender	1	\$149.95



Audible Patil Intubation Guide

Magnifies Breath Sounds During Blind Intubation

• LATEX FREE •

- Lightweight device with a small whistle diaphragm
- 15 mm female attaches to ET tube connector
- Helps magnify breathing sounds during nasotracheal and orotracheal intubation

Item	Description	Qty	\$
9-0014-30	Patil Intubation Audible Guide	1	\$28.95



LMA Cleaning Brushes

Suitable for Cleaning Airways & General Instruments

• LATEX FREE •

- Double ended brushes
- Long brush to clean the airway shaft
- Short brush to clean the mask portion of the airway

Item	Description	Fits LMA Size	O.D.	Qty	\$
1-4500-01	8" Cleaning Brush	1.0	5.25 mm	3	\$12.95
1-4500-15	8" Cleaning Brush	1.5	6.1 mm	3	\$12.95
1-4500-20	8" Cleaning Brush	2.0	7.0 mm	3	\$12.95
1-4500-25	10" Cleaning Brush	2.5	8.4 mm	3	\$12.95
1-4500-34	13" Cleaning Brush	3.0-4.0	11.0 mm	3	\$16.95
1-4500-56	13" Cleaning Brush	5.0-6.0	11.5 mm	3	\$16.95
1-4500-85	5" Double End Cleaning Brush	All	5.0-7.0 mm	3	\$7.95



Patil Intubation Gauge

Measures Distance Between Thyroid Notch and Mandible

• LATEX FREE •

- Measures the distance between the thyroid notch and the lower border of the mandible in the midline with the patient positioned in full neck extension
- Difficult larynx visualization can be anticipated
- Made of chrome plated brass

Item	Description	Qty	\$
9-0014-40	Patil Intubation Gauge	1	\$39.95



GiO Pressure Gauge

Real Time Digital Display of Pressure Measured

- Displays in three pressure units: cm H₂O, mBar, kPa
- Displays peak pressure reading when Peak and Hold function is activated
- Backlight for easy reading in dim environment
- Analog bar display with colors to indicate different pressure ranges
- Auto power off preserves battery life
- Variety of gauge ranges available

Item	Description	Range	Qty	\$
8-1000-01	GiO 1 Pressure Gauge	0-30 cm H ₂ O	1	\$284.95
8-1000-02	GiO 2 Pressure Gauge	0-80 cm H ₂ O	1	\$284.95
8-1000-03	GiO 3 Pressure Gauge	-30-100 cm H ₂ O	1	\$284.95
8-1000-04	GiO 4 Pressure Gauge	-60-0 cm H ₂ O	1	\$284.95
8-1000-05	GiO NIF Filtration Valve	-	30	\$359.95
8-1000-06	Pressure Line + Transducer Replacement Kit	-	1	\$98.95



COMES COMPLETE WITH

- 2 hydrophobic filters
- 2 disposable pressure lines with luer lock connectors
- 1 - 50 cm pressure line
- 2 elbow connectors
- 1 straight connector
- 2 lithium cell batteries



Endotest Cuff Monitor

Cuff Inflator with Manometer

- Used to inflate, deflate and monitor the pressure of high volume, low pressure cuffs
- Easy, one-hand use
- Pressure is easily seen on the clearly marked face of the pressure gauge
- Red switch designed to lodge when fully depressed, allowing cuff pressure to fall to zero

Item	Description	Qty	\$
8-1127-00	Endotest Cuff Monitor	1	\$345.95
8-1127-01	Extension Tubing 103.5 cm long	1	\$14.95



8-5404-00



8-5407-00

Cuff Pressure Gauge

For High Volume, Low Pressure Cuffs

- Release valve and hook
- Vacuum valve
- Luer connection
- Color coded ranges for suitable for ET tube and LMA inflation

Item	Description	Qty	\$
8-5404-00	Original Cuff Pressure Gauge	1	\$171.95
8-5407-00	Universal Cuff Pressure Gauge	1	\$171.95

DISPOSABLE LARYNGOSCOPES • Fiber Optic



\$4.99 each

Go disposable and improve the intubation experience!



\$11 each

LED Disposable Handles

Item	Description	Size	Qty	\$
6015.C	LED Handle	Medium	20	\$220.95
6016.C	LED Handle	Pediatric	20	\$220.95
6017.C	LED Handle	Stubby	20	\$220.95

MainlineMedical.com
more great products online

Fully Disposable Green System Laryngoscopes

Superior Lighting with All Metal Construction

• LATEX FREE • MEDICALLY CLEAN • DISPOSABLE •

- Dual LED combines white and ultraviolet wavelengths for excellent illumination
- Single patient use blades and handles help reduce risk of cross-contamination
- Eliminate reprocessing costs and save significantly
- Medical grade stainless steel blades and aircraft aluminum handles deliver quality that clinicians demand
- Green System compatible

Macintosh Disposable Blades

Item	Description	Size	Qty	\$
6020.C	Macintosh Blade, Neonate	0	20	\$99.95
6021.C	Macintosh Blade, Infant	1	20	\$99.95
6022.C	Macintosh Blade, Child	2	20	\$99.95
6023.C	Macintosh Blade, Med. Adult	3	20	\$99.95
6029.C	Macintosh Blade, Ext. Med. Adult	3.5	20	\$99.95
6024.C	Macintosh Blade, Large Adult	4	20	\$99.95

Miller Disposable Blades

Item	Description	Size	Qty	\$
6040.C	Miller Blade, Premature	000	20	\$99.95
6039.C	Miller Blade, Small Neonate	00	20	\$99.95
6030.C	Miller Blade, Neonate	0	20	\$99.95
6031.C	Miller Blade, Infant	1	20	\$99.95
6035.C	Miller Blade, Small Child	1.5	20	\$99.95
6032.C	Miller Blade, Child	2	20	\$99.95
6033.C	Miller Blade, Med. Adult	3	20	\$99.95
6034.C	Miller Blade, Large Adult	4	20	\$99.95

Fiber Optic • DISPOSABLE LARYNGOSCOPES

GreenLine® D Blades

Best Value

• LATEX FREE • STERILE • DISPOSABLE •

- Made of surgical stainless steel
- Non-painted blade surface
- Suitable for everyday hospital use
- Compatible with all Green System handles



\$4.46 each

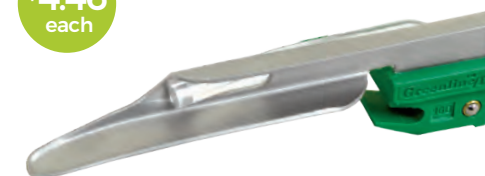

Macintosh Disposable Blades

Item	Description	Size	Qty	\$
5-5332-01	Macintosh Blade, Infant	1	20	\$88.95
5-5332-02	Macintosh Blade, Child	2	20	\$88.95
5-5332-03	Macintosh Blade, Med. Adult	3	20	\$88.95
5-5332-35	Macintosh Blade, Ext. Med Adult	3.5	20	\$88.95
5-5332-04	Macintosh Blade, Large Adult	4	20	\$88.95

Miller Disposable Blades

Item	Description	Size	Qty	\$
5-5333-20	Miller Blade, Premature	00	20	\$88.95
5-5333-00	Miller Blade, Neonate	0	20	\$88.95
5-5333-01	Miller Blade, Infant	1	20	\$88.95
5-5333-02	Miller Blade, Child	2	20	\$88.95
5-5333-03	Miller Blade, Med. Adult	3	20	\$88.95
5-5333-04	Miller Blade, Large Adult	4	20	\$88.95

GreenLine® D All-Metal Blades

Non-Painted Surface

• LATEX FREE • STERILE • DISPOSABLE •

- Flexible Fiber Optic Bundle provides a more focused light
- Designed with three ball bearings in the all-metal heel for secure handle attachment
- Features a beaded tip to reduce tissue trauma
- Constructed of surgical grade 303/304 stainless steel
- Compatible with all Green System handles



\$5.75 each



Macintosh Disposable Blades

Item	Description	Size	Qty	\$
5-5335-01	Macintosh Blade, Infant	1	20	\$114.95
5-5335-02	Macintosh Blade, Child	2	20	\$114.95
5-5335-03	Macintosh Blade, Med. Adult	3	20	\$114.95
5-5335-04	Macintosh Blade, Large Adult	4	20	\$114.95

Miller Disposable Blades

Item	Description	Size	Qty	\$
5-5336-20	Miller Blade, Premature	00	20	\$114.95
5-5336-00	Miller Blade, Neonate	0	20	\$114.95
5-5336-01	Miller Blade, Infant	1	20	\$114.95
5-5336-02	Miller Blade, Child	2	20	\$114.95
5-5336-03	Miller Blade, Med. Adult	3	20	\$114.95
5-5336-04	Miller Blade, Large Adult	4	20	\$114.95

GreenLine® D LED Handles

Exceptional Illumination

• LATEX FREE • STERILE • DISPOSABLE •

- Fully contained unit
- Textured surface ensures secure grip
- Mercury-free pre-installed batteries
- Compatible with all Green System blades

Item	Description	Size	Qty	\$
5-5338-09	Comfort Grip Handle	Medium	20	\$139.95
5-5338-10	Comfort Grip Handle	Penlite	20	\$139.95
5-5338-11	Comfort Grip Handle	Stubby	20	\$139.95
5-5338-12	Comfort Grip Handle	Standard	20	\$139.95



\$6.99 each



\$15.99 each

Brite Pro® Solo

Single Patient Use Blade & Handle in One Package

• LATEX FREE • STERILE • DISPOSABLE •

- Textured comfort grip handle for excellent control and feel
- Blade and handle (with battery) assembled in pouch for immediate use
- Can effectively test light prior to opening sterile package
- Full range of Macintosh and Miller blades packaged with medium handle
- Green System compatible

Macintosh Blade & Handle Combinations

Item	Description	Size	Qty	\$
5-4033-10	Macintosh Blade, Infant + Handle	1	10	\$159.95
5-4033-20	Macintosh Blade, Child + Handle	2	10	\$159.95
5-4033-30	Macintosh Blade, Med. Adult + Handle	3	10	\$159.95
5-4033-40	Macintosh Blade, Large Adult + Handle	4	10	\$159.95

Miller Blade & Handle Combinations

Item	Description	Size	Qty	\$
5-4034-00	Miller Blade, Premature + Handle	00	10	\$159.95
5-4034-01	Miller Blade, Neonate + Handle	0	10	\$159.95
5-4034-10	Miller Blade, Infant + Handle	1	10	\$159.95
5-4034-20	Miller Blade, Child + Handle	2	10	\$159.95
5-4034-30	Miller Blade, Med. Adult + Handle	3	10	\$159.95
5-4034-40	Miller Blade, Large Adult + Handle	4	10	\$159.95

Blade + Handle Packaged Together



\$15.99 each

Brite Pro® Solo Omni

Ultra-Low Blade Profile Design

• LATEX FREE • STERILE • DISPOSABLE •

- Unique profile reduces risk of dental trauma and provides additional space for maneuverability during laryngoscopy
- Textured Comfort Grip handle for excellent control and feel
- Blade and handle (with battery) assembled in pouch for immediate use
- Can effectively test light prior to opening sterile package
- Full range of Macintosh and Miller blades packaged with medium handle
- Quick release battery removal prior to disposal
- Color coded blades for quick size verification
- Green System compatible

Macintosh Blade & Handle Combinations

Item	Description	Size	Qty	\$
5-0401-10	Macintosh Blade, Infant + Handle	1	10	\$159.95
5-0401-20	Macintosh Blade, Child + Handle	2	10	\$159.95
5-0401-30	Macintosh Blade, Med. Adult + Handle	3	10	\$159.95
5-0401-40	Macintosh Blade, Large Adult + Handle	4	10	\$159.95

Miller Blade & Handle Combinations

Item	Description	Size	Qty	\$
5-0404-00	Miller Blade, Premature + Handle	00	10	\$159.95
5-0404-01	Miller Blade, Neonate + Handle	0	10	\$159.95
5-0404-10	Miller Blade, Infant + Handle	1	10	\$159.95
5-0404-20	Miller Blade, Child + Handle	2	10	\$159.95
5-0404-30	Miller Blade, Med. Adult + Handle	3	10	\$159.95
5-0404-40	Miller Blade, Large Adult + Handle	4	10	\$159.95

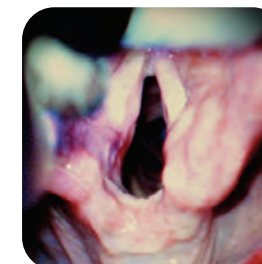

IntuBrite Ultraviolet + White Dual LED

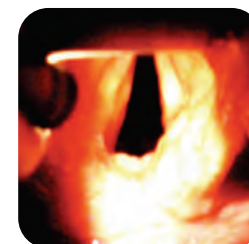

Competitive Fiber Optic LED



1022.C / 2017.C

1023.C / 2015.C

1039.C / 2016.C

IntuBrite® Dual LED Laryngoscopes

Raising the Bar for Airway Illumination

• LATEX FREE • MEDICALLY CLEAN • DISPOSABLE •

- Ultraviolet combined with white LED light provides clear illumination and definition with exceptional depth perception and detail
- Illumination in the blade, powered by the handle
- Outstanding visualization of glottic opening
- Single patient use blades and handles help reduce risk of cross-contamination
- Eliminate reprocessing costs and save significantly
- Medical grade stainless steel blades and aircraft aluminum handles deliver quality that clinicians demand
- Full range of styles and sizes

Macintosh Disposable Blades

Item	Description	Size	Qty	\$
1020.C	Macintosh Blade, Neonate	0	20	\$119.95
1021.C	Macintosh Blade, Infant	1	20	\$119.95
1022.C	Macintosh Blade, Child	2	20	\$119.95
1023.C	Macintosh Blade, Med. Adult	3	20	\$119.95
1029.C	Macintosh Blade, Ext. Med. Adult	3	20	\$119.95
1024.C	Macintosh Blade, Large Adult	4	20	\$119.95

Miller Disposable Blades

Item	Description	Size	Qty	\$
1040.C	Miller Blade, Premature	000	20	\$119.95
1039.C	Miller Blade, Small Neonate	00	20	\$119.95
1030.C	Miller Blade, Neonate	0	20	\$119.95
1031.C	Miller Blade, Infant	1	20	\$119.95
1035.C	Miller Blade, Small Child	1.5	20	\$119.95
1032.C	Miller Blade, Child	2	20	\$119.95
1033.C	Miller Blade, Med. Adult	3	20	\$119.95
1034.C	Miller Blade, Large Adult	4	20	\$119.95

LED Disposable Handles & Accessories

Item	Description	Size	Qty	\$
2015.C	LED Handle	Medium	20	\$133.95
2016.C	LED Handle	Pediatric	20	\$133.95
2017.C	LED Handle	Stubby	20	\$133.95
1058	Storage Bag	-	1	\$14.95

Phillips Disposable Blades

Item	Description	Size	Qty	\$
2001.C	Phillips Blade, Infant	1	20	\$119.95
2002.C	Phillips Blade, Child	2	20	\$119.95

Robertshaw Disposable Blades

Item	Description	Size	Qty	\$
2010.C	Robertshaw Blade, Neonate	0	20	\$119.95
2011.C	Robertshaw Blade, Infant	1	20	\$119.95



\$6.15 each

\$11.99 each



5-7770-00
DispoLED™
Single Use Fiber
Optic Handle
\$239.95
Box/20

Green Rusch Lite™ Metal Blades

Routine & Emergency Intubations

• LATEX FREE • DISPOSABLE •

- Prevent cross contamination
- Ideal for crash carts, every day OR, intubations and emergency situations
- Compatible with all Green System handles

Macintosh Blades

Item	Description	Size	Qty	\$
5-4451-01	Macintosh Blade, Infant/Child	1	20	\$122.95
5-4451-02	Macintosh Blade, Child/Med. Adult	2	20	\$122.95
5-4451-03	Macintosh Blade, Adult	3	20	\$122.95
5-4451-04	Macintosh Blade, Large Adult	4	20	\$122.95

Miller Blades

Item	Description	Size	Qty	\$
5-4550-10	Miller Blade, Premature	00	20	\$122.95
5-4550-00	Miller Blade, Neonate	0	20	\$122.95
5-4550-01	Miller Blade, Infant/Child	1	20	\$122.95
5-4550-02	Miller Blade, Child/Med. Adult	2	20	\$122.95
5-4550-03	Miller Blade, Adult	3	20	\$122.95



\$5.99 each



BriteBlade Pro™ Metal Blades

Low Profile Design

• LATEX FREE • STERILE • DISPOSABLE •

- Ultra low profile blade provides better view and more room to maneuver
- Ideal for crash carts and every day OR intubations
- Compatible with all Green System handles

Macintosh Blades

Item	Description	Size	Qty	\$
5-0471-10	Macintosh Blade, Infant	1	10	\$59.95
5-0471-20	Macintosh Blade, Child	2	10	\$59.95
5-0471-30	Macintosh Blade, Med. Adult	3	10	\$59.95
5-0471-40	Macintosh Blade, Large Adult	4	10	\$59.95

Miller Blades

Item	Description	Size	Qty	\$
5-0472-00	Miller Blade, Premature	00	10	\$59.95
5-0472-01	Miller Blade, Neonate	0	10	\$59.95
5-0472-10	Miller Blade, Infant	1	10	\$59.95
5-0472-20	Miller Blade, Child	2	10	\$59.95
5-0472-30	Miller Blade, Med. Adult	3	10	\$59.95
5-0472-40	Miller Blade, Large Adult	4	10	\$59.95



\$12 each



5-4031-01

5-4031-02

5-4031-00

BritePro™ Solo LED Handles

Comfortable, Soft Grip

• LATEX FREE • STERILE • DISPOSABLE •

- Intense LED light
- Over-molded soft grip handle
- Prevents cross-contamination

Item	Description	Size	Qty	\$
5-4031-00	BritePro Solo LED Handle	Medium	20	\$240.95
5-4031-01	BritePro Solo LED Handle	Stubby	20	\$240.95
5-4031-02	BritePro Solo LED Handle	Mini	20	\$240.95



Disposable Fiber Optic Kits

Ideal for EMS, Paramedics, Crash Carts

• LATEX FREE • STERILE • DISPOSABLE •

- Variety of blade and handle configurations
- All blades are single patient use and fully disposable
- Components in original, sterile packaging inside sturdy canvas pouch

Item	Description	Qty	\$
5-5332-55	2 Disp Std Handles; Mac Blades 2, 3, 4; Miller Blades 2, 3	1 Kit	\$54.95
5-5332-57	1 Disp Std Handle; Disp Stubby Handle; Mac Blades 2, 3, 4; Miller Blades 2, 3	1 Kit	\$54.95
5-5336-54	2 Disp Penlite Handles; All-Metal Mac Blade 1; All Metal Miller Blades 00, 0, 1	1 Kit	\$54.95
5-5333-58	2 Disp Std Handles; Mac Blades 2, 3, 4; Miller Blades 0, 1, 2, 3	1 Kit	\$66.95
5-5333-57	1 Chrome Plated Med Handle; Mac Blades 2, 3, 4; Miller Blades 0, 1, 2, 3	1 Kit	\$94.95
5-5335-47	1 Chrome Plated Med Handle; All Metal Mac Blades 2, 3, 4; All Metal Miller Blades 0, 1, 2, 3	1 Kit	\$129.95



5-5333-58



5-5332-55

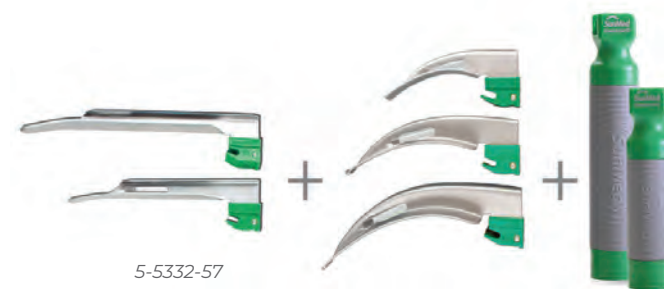

5-5332-57



5-5336-54

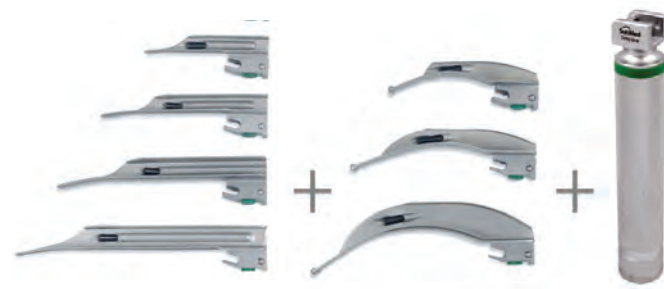

5-5335-47

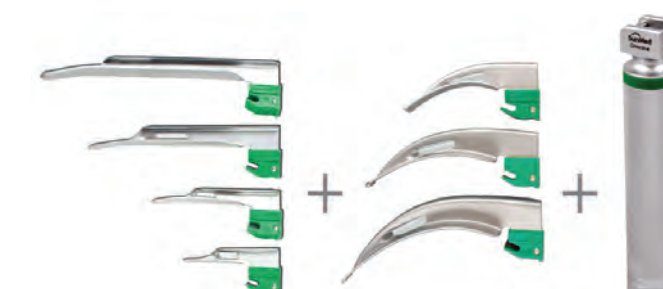

5-5333-57

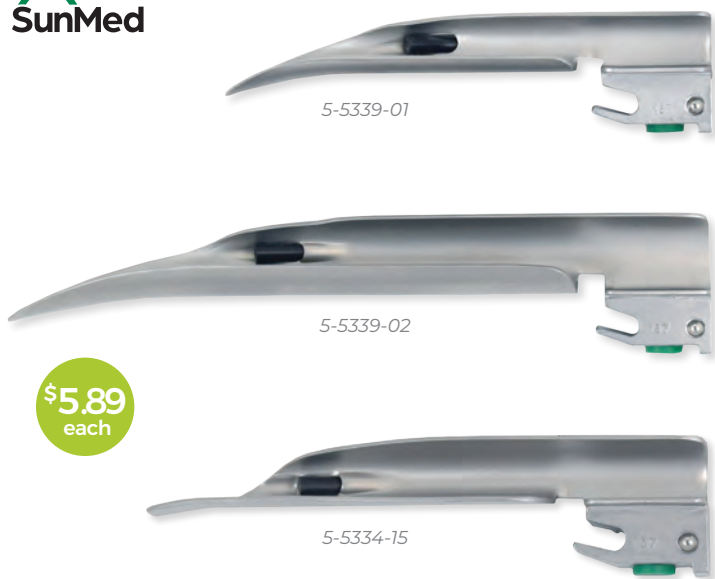

\$5.89 each

GreenLine® D All-Metal Disposable Pediatric Blades

Phillips and Wis-Hipple Blades

• LATEX FREE • STERILE • DISPOSABLE •

- Helps reduce cross-contamination
- Eliminates reprocessing costs of blades
- Flexible fiber optic bundle protected in black plastic sheath
- Designed with three ball bearings in the heel for secure handle attachment
- Constructed of surgical grade 303/304 non-painted stainless steel

Item	Description	Size	Qty	\$
5-5339-01	Phillips, Infant	1	20	\$117.95
5-5339-02	Phillips, Child	2	20	\$117.95
5-5334-15	Wis-Hipple Small Child	1.5	20	\$117.95

Premier Pro Disposable Blades

Macintosh & Miller Blades

• LATEX FREE • STERILE • DISPOSABLE •

- Green System compatible
- Constructed of surgical stainless steel to reduce cleaning and cross-contamination
- ISO 7376 Compliant



\$3.34 each

Miller Disposable Blades

Item	Description	Size	Qty	\$
62500	Premier Pro Miller	00	20	\$66.95
6250	Premier Pro Miller	0	20	\$66.95
6251	Premier Pro Miller	1	20	\$66.95
6252	Premier Pro Miller	2	20	\$66.95
6253	Premier Pro Miller	3	20	\$66.95
6254	Premier Pro Miller	4	20	\$66.95

Macintosh Disposable Blades

Item	Description	Size	Qty	\$
6241	Premier Pro Macintosh	1	20	\$66.95
6242	Premier Pro Macintosh	2	20	\$66.95
6243	Premier Pro Macintosh	3	20	\$66.95
62435	Premier Pro Macintosh	3.5	20	\$66.95
6244	Premier Pro Macintosh	4	20	\$66.95



Complete Intubation Kit with Disposable Laryngoscopes

Pre-Packed, Ready-to-Go!

• LATEX FREE •

- Includes fiber optic disposable laryngoscopes
- All components in original sterile packaging



Item	Description	Qty	\$
8-1050-94	Disposable Fiber Optic Blade Kit	1	\$259.00

KIT INCLUDES:

- 8 Color Coded Guedel Airways (size: 40-100 mm)
- 4 Nasopharyngeal Airways (sizes 20, 24, 28, 32 Fr)
- 2 Uncuffed ET Tubes (sizes 2.5, 4 mm)
- 8 Cuffed ET Tubes (sizes 5-10 mm)
- 1 ET Tube Introducer (Bougie) with Coudé tip
- 1 Adult Stylette
- 1 Adult Magill Forceps
- 1 Pediatric Magill Forceps
- 4 Packets of Sterile Lubricating Jelly
- 1 Syringe (10 mL)
- 1 Nylon Case
- 2 "AA" & "C" Batteries (if applicable)
- Replacement laryngoscope lamps (if applicable)

LARYNGOSCOPE HANDLES & BLADES:

- 1 Penlite Laryngoscope Handle
- 1 Medium Laryngoscope Handle
- 5 Miller Laryngoscope Blades (sizes 0-4)
- 4 Macintosh Laryngoscope Blades (sizes 1-4)



5-0236-70 5-0236-69

GreenLine® D Handles

Smooth or Ribbed Grip

• LATEX FREE • STERILE • DISPOSABLE •

- Fully contained unit
- LED illumination
- Mercury-free pre-installed batteries
- Compatible with all Green System blades

Item	Description	Size	Qty	\$
5-0236-69	Ribbed Grip Handle	Medium	20	\$179.95
5-0236-70	Smooth Grip Handle	Penlite	20	\$190.95



\$5.69 each

Premier Pro LED Handles

Textured Surface for Secure Grip

• LATEX FREE • STERILE • DISPOSABLE •

- Green System compatible
- Constructed of surgical stainless steel to reduce cleaning and cross-contamination
- ISO 7376 Compliant
- LED illumination
- Textured surface for better grip

Item	Description	Size	Qty	\$
6290	Premier Pro LED Handle	Stubby	20	\$113.95
6291	Premier Pro LED Handle	Penlite	20	\$113.95
6292	Premier Pro LED Handle	Medium	20	\$113.95

DISPOSABLE LARYNGOSCOPES • Conventional

SunMed



Macintosh & Miller Disposable LED Conventional Blades

Solves Risk of Contamination

• LATEX FREE • DISPOSABLE •

- Clean, cool white LED illumination
- Made of surgical stainless steel
- Compatible with any brand of conventional laryngoscope handle
- Low power use equals long battery life
- Individually packaged to meet Joint Commission Storage requirements

Macintosh Blades

Item	Description	Size	Qty	\$
5-5132-01	Macintosh LED Blade, Infant	1	1	\$100.95
5-5132-02	Macintosh LED Blade, Child	2	1	\$100.95
5-5132-03	Macintosh LED Blade, Med. Adult	3	1	\$100.95
5-5132-04	Macintosh LED Blade, Large Adult	4	1	\$100.95

Miller Blades

Item	Description	Size	Qty	\$
5-5133-20	Miller LED Blade, Premature	00	1	\$100.95
5-5133-00	Miller LED Blade, Neonate	0	1	\$100.95
5-5133-01	Miller LED Blade, Infant	1	1	\$100.95
5-5133-02	Miller LED Blade, Child	2	1	\$100.95
5-5133-03	Miller LED Blade, Med. Adult	3	1	\$100.95
5-5133-04	Miller LED Blade, Large Adult	4	1	\$100.95

SunMed



Macintosh & Miller Disposable Conventional Laryngoscope Kit

All Components in Original Sterile Packaging

• LATEX FREE • DISPOSABLE •

- Conveniently packaged in sturdy canvas zippered pouch
- Disposable blades solve contamination and cleaning problems
- Ideal for EMS and crash cart applications
- Includes most popular blade sizes

Item	Description	Qty	\$
5-5133-57	LED Conventional 7-Blade Kit: Medium Handle; Mac English Blades: 2, 3, 4; Miller English Blades: 0, 1, 2, 3; Canvas Pouch	1	\$88.95

Reusable • FIBER OPTIC LARYNGOSCOPES

SunMed

GreenLine® Macintosh & Miller German Profile Blades

Most Popular Profile

• LATEX FREE • REUSABLE •

- Fully steam autoclavable
- Quality design with continuous seamless weld-no cracks or crevices to trap debris
- Integral fiber optic bundle offers bright white illumination
- Made of surgical stainless steel
- Compatible with all Green System handles



Macintosh Blades

Item	Description	Size	Qty	\$
5-5272-01	Macintosh G-Profile Blade, Infant	1	1	\$74.95
5-5272-02	Macintosh G-Profile Blade, Child	2	1	\$74.95
5-5272-03	Macintosh G-Profile Blade, Med. Adult	3	1	\$74.95
5-5272-13	Macintosh G-Profile Blade, Med. Adult (Strong Curve)	3	1	\$74.95
5-5272-04	Macintosh G-Profile Blade, Large Adult	4	1	\$74.95

Miller Blades

Item	Description	Size	Qty	\$
5-5273-20	Miller G-Profile Blade, Premature	00	1	\$74.95
5-5273-00	Miller G-Profile Blade, Neonate	0	1	\$74.95
5-5273-01	Miller G-Profile Blade, Infant	1	1	\$74.95
5-5273-15	Miller G-Profile Blade, Ext. Infant	1.5	1	\$74.95
5-5273-02	Miller G-Profile Blade, Child	2	1	\$74.95
5-5273-03	Miller G-Profile Blade, Med. Adult	3	1	\$74.95
5-5273-04	Miller G-Profile Blade, Large Adult	4	1	\$74.95

GreenLine® Macintosh & Miller English Profile Blades

Reduced Flange Size

• LATEX FREE • REUSABLE •

- Size of the flange is reduced to minimize trauma
- Satin finish to eliminate glare
- Made of surgical stainless steel
- Compatible with all Green System handles



Macintosh Blades

Item	Description	Size	Qty	\$
5-5232-01	Macintosh English Blade, Infant	1	1	\$45.95
5-5232-02	Macintosh English Blade, Child	2	1	\$45.95
5-5232-03	Macintosh English Blade, Med. Adult	3	1	\$45.95
5-5232-04	Macintosh English Blade, Large Adult	4	1	\$45.95
5-5232-05	Macintosh English Blade, Ext. Large Adult	5	1	\$45.95

Miller Blades

Item	Description	Size	Qty	\$
5-5233-20	Miller English Blade, Premature	00	1	\$45.95
5-5233-00	Miller English Blade, Neonate	0	1	\$45.95
5-5233-01	Miller English Blade, Infant	1	1	\$45.95
5-5233-15	Miller English Blade, Small Child	1.5	1	\$45.95
5-5233-02	Miller English Blade, Child	2	1	\$45.95
5-5233-03	Miller English Blade, Med. Adult	3	1	\$45.95
5-5233-04	Miller English Blade, Large Adult	4	1	\$45.95



GreenLine® Macintosh American Profile Blades
Strong Curve Design

• LATEX FREE • REUSABLE •

- Slightly stronger curvature
- Flange starts at the lock of the blade and continues to approximately where the curvature changes direction then disappears
- Made of surgical stainless steel
- Green System compatible

Item	Description	Size	Qty	\$
5-5231-00	Macintosh American Blade, Neonate	0	1	\$45.95
5-5231-01	Macintosh American Blade, Infant	1	1	\$45.95
5-5231-02	Macintosh American Blade, Child	2	1	\$45.95
5-5231-03	Macintosh American Blade, Med. Adult	3	1	\$45.95
5-5231-35	Macintosh American Blade, Ext. Med. Adult	3.5	1	\$45.95
5-5231-04	Macintosh American Blade, Large Adult	4	1	\$45.95



GreenLine® Left Handed Macintosh English Profile Blade
Reduced Flange Size

• LATEX FREE • REUSABLE •

- Light on the right side for left handed use
- Flange begins at the lock of blade and continues to the tip as it narrows
- Soft, matte finish helps eliminate reflection and glare
- Made of surgical stainless steel
- Green System compatible

Item	Description	Size	Qty	\$
5-5243-03	Left Handed Macintosh English Blade, Med Adult	3	1	\$67.95



GreenLine® Left Handed Miller American Profile Blades
Distal End Curve Improves Epiglottis Lift

• LATEX FREE • REUSABLE •

- Light on the right side for left handed use
- Reduced flange helps minimize trauma
- Distal end curve improves lifting of epiglottis
- Designed to facilitate greater exposure of larynx
- Made of surgical stainless steel
- Soft, matte finish helps eliminate reflection and glare
- Green System compatible

Item	Description	Size	Qty	\$
5-5230-02	Left Handed Miller American Blade, Child	2	1	\$45.95
5-5230-03	Left Handed Miller American Blade, Med. Adult	3	1	\$45.95



GreenLine® Sun-Flex™ German Profile Blades
Non-Pinching Flexible Tip

• LATEX FREE • REUSABLE •

- Built with an integral, extra large fiber optic bundle delivering a cool, white light
- Design eliminates cracks and crevices, allowing for superior cleaning and the prevention of cross contamination
- Designed to enable precise control to elevate the epiglottis
- Soft, matte finish virtually eliminates reflection and glare
- Made of surgical stainless steel
- Green System compatible

Item	Description	Size	Qty	\$
5-5282-02	Sun-Flex German Blade, Child	2	1	\$239.95
5-5282-03	Sun-Flex German Blade, Med. Adult	3	1	\$229.95
5-5282-04	Sun-Flex German Blade, Large Adult	4	1	\$229.95

Sun-Flex German Blade Kit

Item	Kit Includes	Qty	\$
5-5282-42	Medium Handle (5-0236-09) Replacement Lamp (5-0240-53) Sun-Flex German Blades: 3 (5-5282-03), 4 (5-5282-04) Hard Case (8-1050-72)	1	\$549.95



GreenLine® Siker Mirror American Profile Blade

Frosted Lamp Provides Diffused Illumination without Shadows

• LATEX FREE • REUSABLE •

- Ideal for use on patients with anatomical variations which make intubation with conventional blades difficult or impossible
- The basic portions of the blade make an angle of 135° with a mirror located at flange angle facing spatula for better visualization
- Distal portion is 3"
- Mirror inverts the reflected image – clinician should exercise caution until familiar with its use
- Curved stylet is recommended for use with the Siker blade
- Immersing blade in warm water bath for 10 minutes prior to use will help prevent mirror fogging
- Made of surgical stainless steel

Item	Description	Size	Qty	\$
5-3075-04	Siker Mirror American Blade, Large Adult	4	1	\$52.95



GreenLine® Soper English Profile Blade
Clear Lamp Provides Brighter Illumination

• LATEX FREE • REUSABLE •

- Broad flat blade makes it easier to restrict premature and newborn infant tongue movement
- Made of surgical stainless steel

Item	Description	Size	Qty	\$
5-5080-01	Soper English Blade, Infant	1	1	\$42.95





GreenLine® Blechman American Profile Blade
Effectively Lift Epiglottis in Supine Position

- LATEX FREE • REUSABLE •
- Angled tip elevates the epiglottis in supine patient
- Tongue is swept to the left allowing the blade to tip upward for effective viewing from the right side
- Soft, matte finish virtually eliminates reflection and glare
- Made of surgical stainless steel
- Green System compatible

Item	Description	Size	Qty	\$
5-5241-03	Blechman American Blade, Med. Adult	3	1	\$75.95



GreenLine® Improved Vision American Profile Blades
Extended Channel for Better Visualization

- LATEX FREE • REUSABLE •
- Channel extends from heel to mid-blade for improved visualization of the cords
- Channel design helps guide endotracheal tube insertion
- Soft, matte finish virtually eliminates reflection and glare
- Made of surgical stainless steel
- Green System compatible

Item	Description	Size	Qty	\$
5-5254-02	Improved Vision American Blade, Child	2	1	\$49.95
5-5254-03	Improved Vision American Blade, Med. Adult	3	1	\$49.95
5-5254-35	Improved Vision American Blade, Ext. Med. Adult	3.5	1	\$49.95
5-5254-04	Improved Vision American Blade, Large Adult	4	1	\$49.95



GreenLine® Improved Vision English Profile Blades
Extended Channel for Better Visualization

- LATEX FREE • REUSABLE •
- Channel extends from heel to mid-blade for improved visualization of the cords
- Channel design helps guide endotracheal tube insertion
- Soft, matte finish virtually eliminates reflection and glare
- Made of surgical stainless steel
- Green System compatible

Item	Description	Size	Qty	\$
5-5246-02	Improved Vision English Blade, Child	2	1	\$49.95
5-5246-03	Improved Vision English Blade, Med. Adult	3	1	\$49.95
5-5246-35	Improved Vision English Blade, Ext. Med. Adult	3.5	1	\$49.95
5-5246-04	Improved Vision English Blade, Large Adult	4	1	\$49.95



GreenLine® Reduced Flange Macintosh Blades
Gentle, Extended Channel Design

- LATEX FREE • REUSABLE •
- Channel extends from heel to mid-blade for improved visualization of the cords
- Channel design helps guide endotracheal tube insertion
- Soft, matte finish virtually eliminates reflection and glare
- Made of surgical stainless steel
- Green System compatible

Item	Description	Size	Qty	\$
5-5271-02	Reduced Flange Macintosh Blade, Child	2	1	\$49.95
5-5271-03	Reduced Flange Macintosh Blade, Med. Adult	3	1	\$49.95
5-5271-35	Reduced Flange Macintosh Blade, Ext. Med. Adult	3.5	1	\$49.95
5-5271-04	Reduced Flange Macintosh Blade, Large Adult	4	1	\$49.95



GreenLine® Flange-Less American Profile Blades
Greatly Reduces the Potential of Trauma During Laryngoscopy

- LATEX FREE • REUSABLE •
- Absent upper flange on curved blade is effective for use on patients with limited mouth opening, prominent incisors, receding mandible, short thick neck, or larynx in an extreme anterior anatomical position
- Soft, matte finish virtually eliminates reflection and glare
- Made of surgical stainless steel
- Green System compatible

Item	Description	Size	Qty	\$
5-5242-03	Flange-Less American Blade, Med. Adult	3	1	\$75.95
5-5242-04	Flange-Less American Blade, Large Adult	4	1	\$75.95

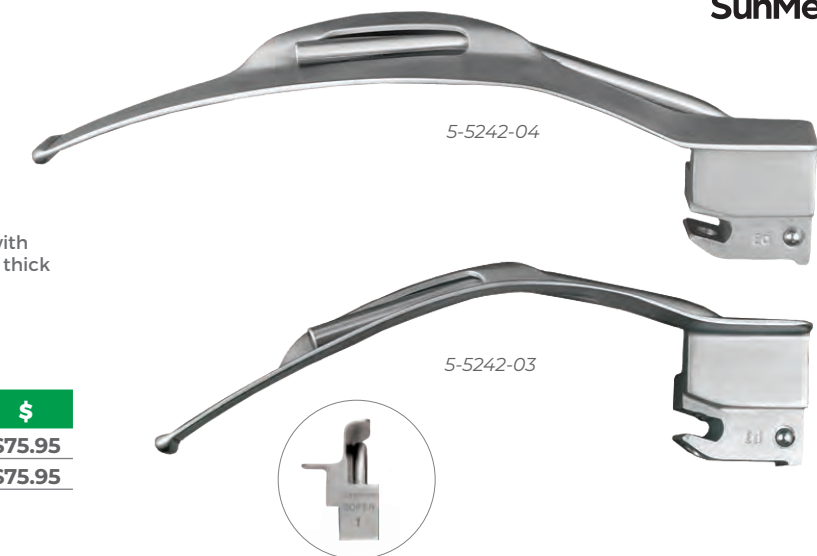

GreenLine® Whitehead American Profile Blade
Modification of Wisconsin Blade

- LATEX FREE • REUSABLE •
- Reduced flange increases visualization to facilitate intubation
- Designed to reduce potential damage to incisors
- Soft, matte finish virtually eliminates reflection and glare
- Made of surgical stainless steel
- Green System compatible

Item	Description	Size	Qty	\$
5-5244-03	Whitehead American Blade, Med. Adult	3	1	\$75.95





GreenLine® PrismView™ American Profile Blades

Polished Prism Without Image Inversion

• LATEX FREE • REUSABLE •

- Optically polished prism with 30° refraction without image inversion
- Ideal when the view of the vocal cords is impaired—especially anterior larynx—during nasal intubation, and for post operative examination of the larynx
- Prevent condensation by immersing blade in warm water bath for 10 minutes prior to use
- Soft, matte finish virtually eliminates reflection and glare
- Made of surgical stainless steel
- Green System compatible

Item	Description	Size	Qty	\$
5-5229-02	PrismView American Blade, Child	2	1	\$79.95
5-5229-03	PrismView American Blade, Med. Adult	3	1	\$79.95
5-5229-35	PrismView American Blade, Ext. Med. Adult	3.5	1	\$79.95
5-5229-04	PrismView American Blade, Large Adult	4	1	\$79.95

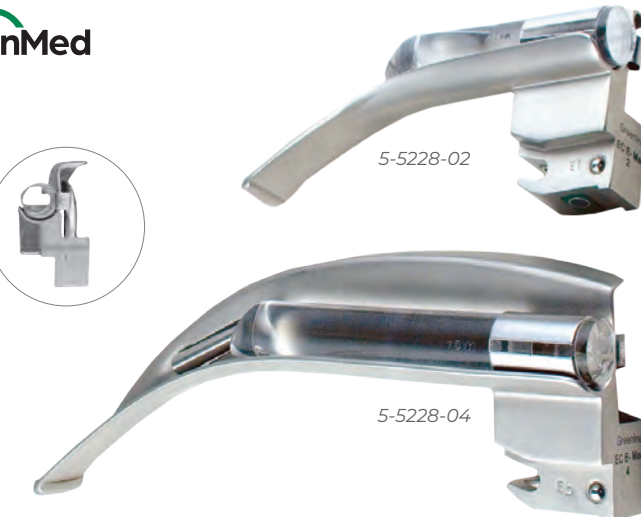

GreenLine® PrismView™ English Profile Blades

Polished Prism Without Image Inversion

• LATEX FREE • REUSABLE •

- Optically polished prism with 30° refraction without image inversion
- Ideal when the view of the vocal cords is impaired—especially anterior larynx—during nasal intubation, and for post operative examination of the larynx
- Prevent condensation by immersing blade in warm water bath for 10 minutes prior to use
- Soft, matte finish virtually eliminates reflection and glare
- Made of surgical stainless steel
- Green System compatible

Item	Description	Size	Qty	\$
5-5228-02	PrismView English Blade, Child	2	1	\$79.95
5-5228-03	PrismView English Blade, Med. Adult	3	1	\$79.95
5-5228-35	PrismView English Blade, Ext. Med. Adult	3.5	1	\$79.95
5-5228-04	PrismView English Blade, Large Adult	4	1	\$79.95

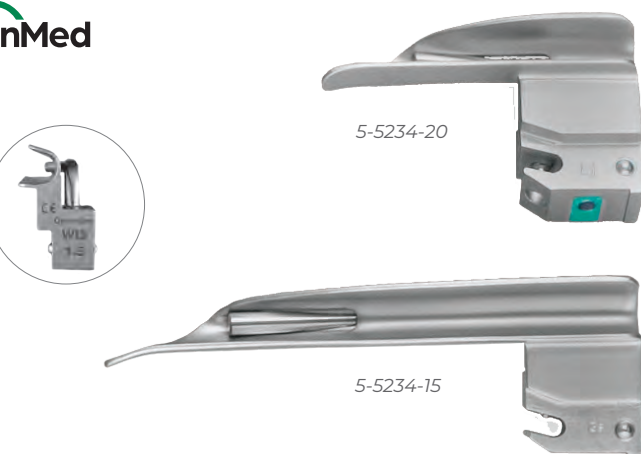

GreenLine® Wis-Hipple American Profile Blades

Designed Primarily for Use in Infants

• LATEX FREE • REUSABLE •

- Wisconsin-modified blade with a straight spatula and a large, circular flange
- Wider, flat tip is well-adapted to lifting the epiglottis
- Soft, matte finish virtually eliminates reflection and glare
- Made of surgical stainless steel
- Green System compatible

Item	Description	Size	Qty	\$
5-5234-20	Wis-Hipple American Blade, Premature	00	1	\$45.95
5-5234-00	Wis-Hipple American Blade, Newborn	0	1	\$45.95
5-5234-01	Wis-Hipple American Blade, Infant	1	1	\$45.95
5-5234-15	Wis-Hipple American Blade, Small Child	1.5	1	\$45.95

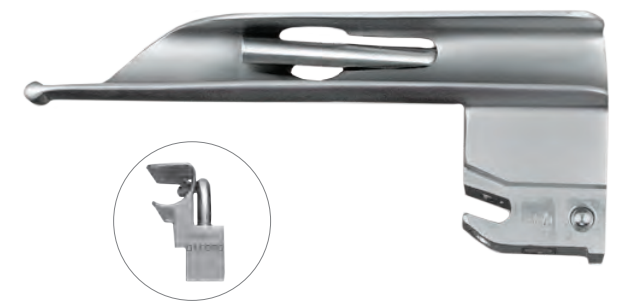

GreenLine® Oxford English Profile Blade

Open Side Overhang Prevents Lip from Obstructing Vision

• LATEX FREE • REUSABLE •

- Suitable for premature infants, babies and young children up to 4 years old
- Broad, flat surface aids pediatric patients with extreme cleft palates
- Soft, matte finish virtually eliminates reflection and glare
- Made of surgical stainless steel
- Green System compatible

Item	Description	Size	Qty	\$
5-5238-01	Oxford English Blade, Infant	1	1	\$63.95



GreenLine® Seward English Profile Blades

Pediatric Size Available

• LATEX FREE • REUSABLE •

- Originally produced as an infant blade for use; it is now available to fit older children
- Soft, matte finish virtually eliminates reflection and glare
- Made of surgical stainless steel
- Green System compatible

Item	Description	Size	Qty	\$
5-5239-01	Seward English Blade, Infant	1	1	\$63.95
5-5239-02	Seward English Blade, Child	2	1	\$63.95



GreenLine® Miller-Port Blades

Help Reduce Risk of Hypoxia During Intubation

• LATEX FREE • REUSABLE •

- Specifically designed to perform laryngoscopy and intubation with reduced risk of hypoxia
- Integrated tube permits delivery of oxygen or other gas mixtures during intubation
- Soft, matte finish virtually eliminates reflection and glare
- Made of surgical stainless steel
- Green System compatible

Item	Description	Size	Qty	\$
5-5248-00	Miller-Port Blade, Newborn	0	1	\$66.95
5-5248-01	Miller-Port Blade, Infant	1	1	\$66.95



GreenLine® Wisconsin American Profile Blades

Wider Distal End Helps Lift Epiglottis

• LATEX FREE • REUSABLE •

- Straight spatula with flange that expands slightly toward the distal portion of the blade increases visual field to help prevent potential tissue trauma
- Distal portion of the blade is wider and formed slightly to the right, making it well-adapted to lifting the epiglottis
- Soft, matte finish virtually eliminates reflection and glare
- Made of surgical stainless steel
- Green System compatible

Item	Description	Size	Qty	\$
5-5234-02	Wisconsin American Blade, Child	2	1	\$45.95
5-5234-03	Wisconsin American Blade, Med. Adult	3	1	\$45.95
5-5234-04	Wisconsin American Blade, Large Adult	4	1	\$45.95

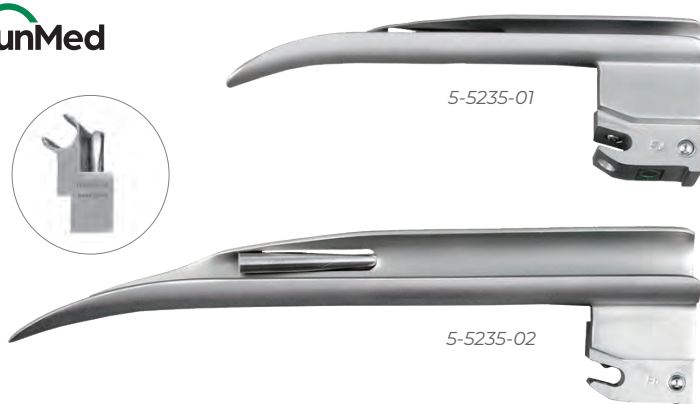

GreenLine® Phillips American Profile Blades
Low Profile Flange Helps Reduce Risk of Oral Damage

•LATEX FREE •REUSABLE•

- Curved distal tip allows for greater visibility and a “direct line” into trachea
- Unique lamp mounting enables deep illumination, downward and inward
- Soft, matte finish virtually eliminates reflection and glare
- Made of surgical stainless steel
- Green System compatible

Item	Description	Size	Qty	\$
5-5235-01	Phillips American Blade, Child	1	1	\$45.95
5-5235-02	Phillips American Blade, Adult	2	1	\$45.95

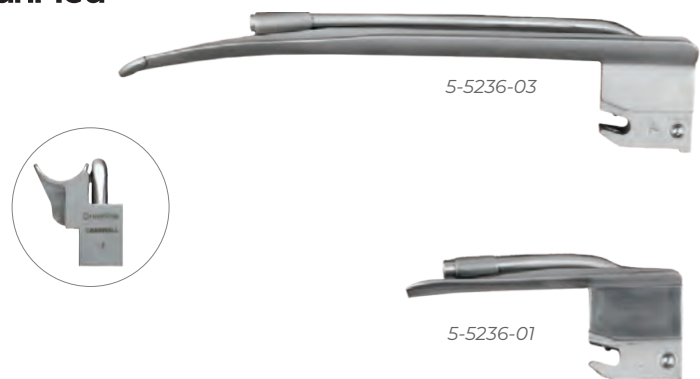

GreenLine® Cranwall American Profile Blades
Can Be Used as a Left-Handed Blade

•LATEX FREE •REUSABLE•

- Significantly reduced flange allows easier insertion through restricted opening, such as arthritic jaw or facial burns
- Design helps decrease potential damage to upper teeth
- Soft, matte finish virtually eliminates reflection and glare
- Made of surgical stainless steel
- Green System compatible

Item	Description	Size	Qty	\$
5-5236-00	Cranwall American Blade, Newborn	0	1	\$45.95
5-5236-01	Cranwall American Blade, Infant	1	1	\$45.95
5-5236-02	Cranwall American Blade, Child	2	1	\$45.95
5-5236-03	Cranwall American Blade, Med. Adult	3	1	\$45.95



GreenLine® Robertshaw English Profile Blades
Designed Specifically for Infants & Children

•LATEX FREE •REUSABLE•

- Spatula is gently curved over the distal third and can indirectly lift epiglottis
- Binocular vision allowing better judgment of depth and less risk of trauma
- Soft, matte finish virtually eliminates reflection and glare
- Made of surgical stainless steel
- Green System compatible

Item	Description	Size	Qty	\$
5-5237-00	Robertshaw English Blade, Newborn	0	1	\$65.95
5-5237-01	Robertshaw English Blade, Infant	1	1	\$65.95



GreenLine® Snow American Profile Blade
Curves Back from Distal End for Convenient Visual Field

•LATEX FREE •REUSABLE•

- Combined Miller spatula and the Wis-Foregger flange design can reduce trauma during intubation, especially for use with a cuffed tube
- Soft, matte finish virtually eliminates reflection and glare
- Made of surgical stainless steel
- Green System compatible

Item	Description	Size	Qty	\$
5-5249-03	Snow American Blade, Med. Adult	3	1	\$63.95



GreenLine® Laryngoscope Kits

Stored in High Impact Plastic Case for Easy & Safe Transport

•LATEX FREE •REUSABLE•

- All reusable blades and handles compatible with Welch Allyn, Propper, Rusch, Heine and AMS
- Blades available in Macintosh and Miller, American, and English profiles
- Blades made of surgical stainless steel
- Green System compatible

Macintosh American Profile

Item	Kit Includes	Qty	\$
5-5231-44	Medium Handle (5-0236-09) Replacement Lamp (5-0240-53) Macintosh Blades: 1 (5-5231-01), 2 (5-5231-02), 3 (5-5231-03), 4 (5-5231-04) Hard Case (8-1050-73)	1	\$258.95

Macintosh English Profile

Item	Kit Includes	Qty	\$
5-5232-44	Medium Handle (5-0236-09) Replacement Lamp (5-0240-53) Macintosh Blades: 1 (5-5232-01), 2 (5-5232-02), 3 (5-5232-03), 4 (5-5232-04) Hard Case (8-1050-73)	1	\$258.95

Miller English Profile

Item	Kit Includes	Qty	\$
5-5233-45	Medium Handle (5-0236-09) Replacement Lamp (5-0240-53) Miller Blades: 0 (5-5233-00), 1 (5-5233-01), 2 (5-5233-02), 3 (5-5233-03), 4 (5-5233-04) Hard Case (8-1050-71)	1	\$288.95

Macintosh/Miller English Profile Combination

Item	Kit Includes	Qty	\$
5-5233-47	Medium Handle (5-0236-09) Replacement Lamp (5-0240-53) Macintosh Blades: 2 (5-5232-02), 3 (5-5232-03), 4 (5-5232-04) Miller Blades: 0 (5-5233-00), 1 (5-5233-01), 2 (5-5233-02), 3 (5-5233-03) Hard Case (8-1050-77)	1	\$390.95

Macintosh American/Miller English Profile Combination

Item	Kit Includes	Qty	\$
5-5232-47	Medium Handle (5-0236-09) Replacement Lamp (5-0240-53) Macintosh Blades: 2 (5-5231-02), 3 (5-5231-03), 4 (5-5231-04) Miller Blades: 0 (5-5233-00), 1 (5-5233-01), 2 (5-5233-02), 3 (5-5233-03) Hard Case (8-1050-77)	1	\$390.95



5-5231-44



5-5232-44



5-5233-45



5-5233-47



5-5232-47



5-5272-44



5-5273-45



5-5272-47



5-5282-42



GreenLine® German Profile Laryngoscope Kits

All Components Can Be Reprocessed

• LATEX FREE • REUSABLE •

- Conveniently packaged laryngoscope kit with handle and blades
- High impact plastic case for easy transport
- Sturdy foam insert carefully protects components
- Includes medium handle with most popular German profile blade sizes
- Blades made of surgical stainless steel
- Green System compatible

Macintosh German Profile

Item	Kit Includes	Qty	\$
5-5272-44	Medium Handle (5-0236-09) Replacement Lamp (5-0240-53) Macintosh Blades: 1 (5-5272-01), 2 (5-5272-02), 3 (5-5272-03), 4 (5-5272-04) Hard Case (8-1050-73)	1	\$356.95

Miller German Profile

Item	Kit Includes	Qty	\$
5-5273-45	Medium Handle (5-0236-09) Replacement Lamp (5-0240-53) Miller Blades: 0 (5-5273-00), 1 (5-5273-01), 2 (5-5273-02), 3 (5-5273-03), 4 (5-5273-04) Hard Case (8-1050-71)	1	\$419.95

Macintosh/Miller German Profile

Item	Kit Includes	Qty	\$
5-5272-47	Medium Handle (5-0236-09) Replacement Lamp (5-0240-53) Macintosh Blades: 2 (5-5272-02), 3 (5-5272-03), 4 (5-5272-04) Miller Blades: 0 (5-5273-00), 1 (5-5273-01), 2 (5-5273-02), 3 (5-5273-03) Hard Case (8-1050-77)	1	\$560.95

Sun-Flex German Profile

Item	Kit Includes	Qty	\$
5-5282-42	Medium Handle (5-0236-09) Replacement Lamp (5-0240-53) Sun-Flex German Blades: 3 (5-5282-03), 4 (5-5282-04) Hard Case (8-1050-72)	1	\$539.95

Laryngoscope Case

Durable Polypropylene Protects Blades and Handles

• LATEX FREE • REUSABLE •

- Removable foam inserts allow for a custom fit
- Protect your laryngoscopes
- Integrated handle for easy carrying

Item	Description	Dimensions	Qty	\$
5-5641-01	Laryngoscope Case	9.25" x 6" x 1.875"	1	\$20.95



Macintosh & Miller Laryngoscope Kits

Medium Handle with Popular Blade Sizes

• LATEX FREE • REUSABLE •

- Bipolar handle allows laryngoscope to function irrespective of the way the batteries are inserted
- Handle can be opened from either end in order to remove batteries with ease
- Knurled finish stainless steel handle
- Provides a clear, crisp light

Macintosh

Item	Kit Includes	Qty	\$
5-4086-00	Medium Handle Macintosh Blades: 1, 2, 3 Hard Case	1	\$166.95

Macintosh

Item	Kit Includes	Qty	\$
5-4086-10	Medium Handle Macintosh Blades: 1, 2, 3, 4 Hard Case	1	\$204.95

Macintosh

Item	Kit Includes	Qty	\$
5-4086-20	Medium Handle Macintosh Blades: 2, 3, 4 Hard Case	1	\$166.95

Miller 6-Blade Kit

Item	Kit Includes	Qty	\$
5-4087-40	Medium Handle Miller Blades: 00, 0, 1, 2, 3, 4 Hard Case	1	\$295.95



5-4086-00



5-4086-10



5-4086-20



5-4087-40



MainlineMedical.com

more great products online

FIBER OPTIC LARYNGOSCOPES • Handles



5-0236-80

5-0236-89

GreenLine® Premium Chrome Plated Handles

Superior LED Illumination

• LATEX FREE • REUSABLE •

- Compatible with all Green System fiber optic blades
- Chrome plated brass
- Premium LED handles have a lifetime warranty
- Low power use prolongs battery life
- Batteries not included

Item	Description	Size	Battery	Qty	\$
5-0236-80	Premium Chrome Plated Handle	Penlite	2-AA	1	\$129.95
5-0236-89	Premium Chrome Plated Handle	Medium	2-C	1	\$129.95



5-0240-61

5-0240-62

5-0240-63



5-0235-09



5-0235-22



5-0238-59



5-0238-60



5-0240-52



5-0240-53



5-0240-54



5-0240-59



5-0416-01



5-1994-07



5-0236-15

5-0236-09

5-0236-10

5-0236-11

GreenLine® Chrome Plated Handles

Bright Halogen Xenon Lamp

• LATEX FREE • REUSABLE •

- Compatible with all Green System fiber optic blades
- Chrome plated brass
- Batteries not included

Item	Description	Size	Battery	Qty	\$
5-0236-09	Chrome Plated Handle	Medium	2-C	1	\$56.95
5-0236-10	Chrome Plated Handle	Penlite	2-AA	1	\$56.95
5-0236-11	Chrome Plated Handle	Stubby	2-AA	1	\$61.95
5-0236-15	Chrome Plated Handle	Large	2-D	1	\$56.95

Fiber Optic Replacement Lamps

2.5-3.5 Volt Laryngoscope Lamps

• LATEX FREE •

- For use with all fiber optic handles
- Meets stringent manufacturing controls
- Frosted lamps provide diffused illumination without shadows
- Clear lamps provide bright illumination

Item	Description	Qty	\$
5-0235-09	SunMed Lamp, Black Plastic Collar	1	\$14.95
5-0235-22	Rusch Emerald, Silver Base Lamp, 2002 & Prior	6	\$97.95
5-0238-59	SunMed Lamp, No Threads	1	\$14.95
5-0238-60	SunMed Replacement Lamp	1	\$13.95
5-0240-52	SunMed GreenLine Red Base Newest Lamp	1	\$10.95
5-0240-53	SunMed Push-Pin Lamp	1	\$12.95
5-0240-54	SunMed SunBrite Lamp, Oct. 2015 & Prior	1	\$28.95
5-0240-59	SunMed GreenLine Black Base Original Lamp	1	\$15.95
5-0240-61	Xenon Halogen Lamp, Blue	1	\$17.95
5-0240-62	ECO LED Lamp, Orange	1	\$20.95
5-0240-63	High-End LED Lamp, Yellow	1	\$44.95
5-0416-01	Flexicare Halogen Lamp	1	\$16.95
5-1994-07	Propper Xenon Lamp	1	\$23.95

Handles • FIBER OPTIC LARYNGOSCOPES



GreenLine® Handles

Durable, Stainless Steel

• LATEX FREE • REUSABLE •

- Made of surgical stainless steel
- Xenon halogen reflector lamp produces the whitest, brightest illumination
- Batteries not included
- Compatible with all Green System fiber optic blades

Item	Description	Size	Battery	Qty	\$
5-0236-35	Stainless Steel Handle	Large	2-D	1	\$64.95
5-0236-39	Stainless Steel Handle	Medium	2-C	1	\$63.95
5-0236-30	Stainless Steel Handle	Penlite	2-AA	1	\$63.95
5-0236-31	Stainless Steel Handle	Stubby	2-AAA	1	\$63.95
5-0236-38	Stainless Steel Handle	Mini	Lithium 123	1	\$67.95
5-0236-36	Stainless Steel Handle	Micro Mini	Lithium 123	1	\$64.95



5-0236-35

5-0236-39

5-0236-30

GreenLine® SunBrite™ LED Handles

Long-Life Reliable Illumination

• LATEX FREE • REUSABLE •

- Twice as bright as conventional illumination
- 10,000 Hours LED life
- Chrome-plated brass with matte finish
- Longer battery life
- Compatible with all Green System fiber optic blades

Item	Description	Size	Battery	Qty	\$
5-0236-90	SunBrite LED Handle	Penlite	2-AA	1	\$99.95
5-0236-91	SunBrite LED Handle	Stubby	2-AAA	1	\$99.95
5-0236-99	SunBrite LED Handle	Medium	2-C	1	\$99.95



5-0236-99

5-0236-90

5-0236-91

Howland Lock for Fiber Optic Systems

Assists in Difficult Intubations

• LATEX FREE • REUSABLE •

- Natural lifting simplifies laryngeal exposure, making intubation possible even in the most difficult cases
- Built-in leverage decreases prying and reduces possibility of broken teeth
- Compatible with Green System fiber optic handles and blades
- Can often make an otherwise certain tracheotomy unnecessary

Item	Description	Qty	\$
5-0236-16	Fiber Optic Howland Lock	1	\$54.95





Lightweight Handles

Excellent Illumination

• LATEX FREE • REUSABLE •

- Knurled finish for secure grip
- Single HPX lamp cartridge design for all sizes

Item	Description	Battery	Qty	\$
5-6081-03	Medium FO Handle	2-C	1	\$100.95
5-6081-04	Penlite FO Handle	2-AA	1	\$100.95
5-6081-05	Stubby FO Handle	2-AA	1	\$167.95
5-0600-00	Replacement Lamp, 2.5v	-	1	\$23.95



5-0239-56 5-0239-58 5-0239-60



5-0239-61 5-0239-62 5-0239-63



5-0239-64 5-0239-65 5-0239-66



5-0239-67 5-0239-68



Rechargeable Handle System

For Laryngoscope, Otoscope and Ophthalmoscopes

• LATEX FREE • REUSABLE •

- Compatible with Welch Alllyn handles only
- Accommodates 3.5v and 2.5v rechargeable handles
- Components all sold separately

Item	Description	Qty	\$
5-0239-30	Universal Charger for 3.5v, 2.5v Handles	1	\$281.95
5-0239-32	Rechargeable Handle (3.5v) for Laryngoscope, Otoscope, Ophthalmoscopes	1	\$313.95
5-7220-00	Battery for Rechargeable Handle (3.5v)	1	\$49.95
5-0239-36	Lamps for Rechargeable Handle	6	\$179.95
5-0239-38	Lamp Cartridge Replacement for Rechargeable Handle	1	\$99.95

Diagnostic Replacement Lamps

For WelchAlllyn Fiber Optic Handles

• LATEX FREE •

- 2.5-15.1 Volt laryngoscope lamps
- Meets stringent manufacturing controls

Item	Description	Volt	Qty	\$
5-0239-56	Replacement Lamp For W/A 06000	2.5	1	\$8.95
5-0239-58	Replacement Lamp For W/A 00300	3.5	1	\$12.95
5-0239-60	Replacement Lamp For W/A 00200	2.5	1	\$5.95
5-0239-61	Replacement Lamp For W/A 03000	3.5	1	\$9.95
5-0239-62	Replacement Lamp For W/A 03100	3.5	1	\$9.95
5-0239-63	Replacement Lamp For W/A 04900	3.5	1	\$9.95
5-0239-64	Replacement Lamp For W/A 03400	2.5	1	\$9.95
5-0239-65	Replacement Lamp For W/A 04400	2.5	1	\$9.95
5-0239-67	Replacement Lamp For W/A 06100	15.1	1	\$19.95
5-0239-68	Replacement Lamp For W/A 07800	6.0	1	\$11.95



Macintosh English & American Profile Blades

Direct Visualization

• LATEX FREE • REUSABLE •

- Curved design allows the tip to be naturally guided to the epiglottic vallecula to facilitate direct tissue visualization

Item	Description	Size	Qty	\$
5-4083-10	Macintosh English Blade, Infant	1	1	\$44.95
5-4083-20	Macintosh English Blade, Child	2	1	\$44.95
5-4083-30	Macintosh English Blade, Med. Adult	3	1	\$44.95
5-4083-40	Macintosh English Blade, Large Adult	4	1	\$44.95
5-4089-10	Macintosh American Blade, Infant	1	1	\$44.95
5-4089-20	Macintosh American Blade, Child	2	1	\$44.95
5-4089-30	Macintosh American Blade, Med. Adult	3	1	\$44.95
5-4089-40	Macintosh American Blade, Large Adult	4	1	\$44.95



Miller Blades

Ideal for Large Epiglottis

• LATEX FREE • REUSABLE •

- Straight design with a shallow curved tip provides greater control in patients whose epiglottis is abnormally large



Wisconsin Blades

Neonatal Through Adult Sizes

• LATEX FREE • REUSABLE •

- Designed for neonatal and infant use
- Provides improved view and greater control of the epiglottis with subtly wider distal end than standard Miller blade

Item	Description	Size	Qty	\$
5-4085-00	Miller Blade, Premature	00	1	\$44.95
5-4085-01	Miller Blade, Neonate	0	1	\$44.95
5-4085-10	Miller Blade, Infant	1	1	\$44.95
5-4085-20	Miller Blade, Child	2	1	\$44.95
5-4085-30	Miller Blade, Med. Adult	3	1	\$44.95
5-4085-40	Miller Blade, Large Adult	4	1	\$44.95

Item	Description	Size	Qty	\$
5-4092-00	Wisconsin Blade, Neonate	0	1	\$44.95
5-4092-10	Wisconsin Blade, Infant	1	1	\$44.95
5-4092-20	Wisconsin Blade, Child	2	1	\$44.95
5-4092-30	Wisconsin Blade, Med. Adult	3	1	\$44.95
5-4092-40	Wisconsin Blade, Large Adult	4	1	\$44.95



Seward Blades

Infant & Pediatric Sizes

• LATEX FREE • REUSABLE •

- Designed originally as infant blade for asphyxia neonatorum
- Available for peditrics

Item	Description	Size	Qty	\$
5-4095-10	Seward Blade, Infant	1	1	\$52.95
5-4095-20	Seward Blade, Child	2	1	\$52.95



Robertshaw Blades

Gentle, Shallow Curve

• LATEX FREE • REUSABLE •

- Designed for neonatal and infant use
- Blade features gentle shallow curvature to lift epiglottis indirectly
- Modification of Macintosh Blade

Item	Description	Size	Qty	\$
5-4093-00	Robertshaw Blade, Infant	0	1	\$52.95
5-4093-10	Robertshaw Blade, Child	1	1	\$52.95

FIBER OPTIC LARYNGOSCOPES • Reusable

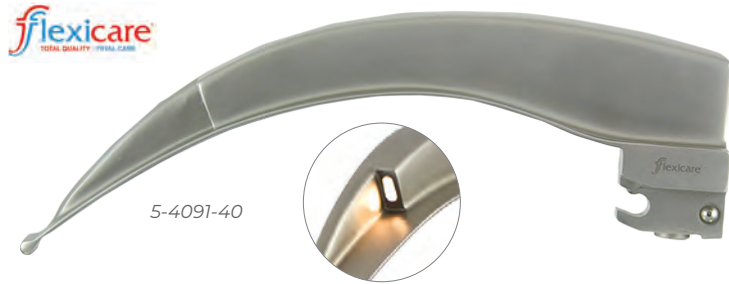

IntegraBlade Macintosh Blades

Wide Fiber Optic Bundle

• LATEX FREE • REUSABLE •

- Designed with an integrated wide-profile fiber optic bundle for maximum light transfer
- Made of surgical stainless steel
- Fully autoclavable

Item	Description	Size	Qty	\$
5-4091-10	Integrated Bundle Mac Blade, Infant	1	1	\$73.95
5-4091-20	Integrated Bundle Mac Blade, Child	2	1	\$73.95
5-4091-30	Integrated Bundle Mac Blade, Med. Adult	3	1	\$73.95
5-4091-40	Integrated Bundle Mac Blade, Large Adult	4	1	\$73.95



BritePro™ Max LED Handle

Intense Bright White Illumination

• LATEX FREE • REUSABLE •

- Bulb will last the lifetime of the handle
- Fully autoclavable
- Made of surgical stainless steel
- Batteries will work in either direction
- Five year warranty

Item	Description	Size	Qty	\$
5-0408-13	BritePro Handle	Medium	1	\$124.95



Flexible Tip Macintosh Blades

Improve Visualization During Intubation

• LATEX FREE • REUSABLE •

- Flip tip aids in difficult intubation by improving visualization of the larynx
- Fully autoclavable

Item	Description	Size	Qty	\$
5-4083-50	Flexible Macintosh Blade, Med. Adult	3	1	\$239.95
5-4083-60	Flexible Macintosh Blade, Large Adult	4	1	\$239.95



Fiber Optic Handles

Bipolar Battery Function

• LATEX FREE • REUSABLE •

- Handle can be opened from either end
- Knurled finish stainless steel
- Clear, crisp light
- No rubber rings

Item	Description	Size	Qty	\$
5-0408-11	Fiber Optic Handle	Medium	1	\$58.95
5-0408-12	Fiber Optic Handle	Penlite	1	\$58.95
5-0408-23	Fiber Optic Handle	Stubby	1	\$58.95
5-0416-01	Replacement Bulb	--	1	\$16.95

Reusable • FIBER OPTIC LARYNGOSCOPES

Macintosh & Miller Blades

No Exposed Light Bundle

• LATEX FREE • REUSABLE •

- Integrated fiber optics offer a brighter light source
- No external light tubes for ease of cleaning
- Meets and exceeds Joint Commission Standards
- Compatible with all Green System handles



Macintosh Blades

Item	Description	Size	Qty	\$
5-1991-61	Macintosh Blade, Infant	1	1	\$166.95
5-1991-44	Macintosh Blade, Child	2	1	\$162.95
5-1991-45	Macintosh Blade, Med. Adult	3	1	\$162.95
5-1991-46	Macintosh Blade, Large Adult	4	1	\$167.95
5-1991-62	Macintosh Blade, X-Large Adult	5	1	\$200.95

Miller Blades

Item	Description	Size	Qty	\$
5-1991-56	Miller Blade, Neonate	0	1	\$166.95
5-1991-57	Miller Blade, Infant	1	1	\$166.95
5-1991-55	Miller Blade, Toddler	1.5	1	\$166.95
5-1991-58	Miller Blade, Child	2	1	\$166.95
5-1991-59	Miller Blade, Med. Adult	3	1	\$140.95
5-1991-60	Miller Blade, Large Adult	4	1	\$166.95



Xenon Stainless Steel Handles

100% Autoclavable

• LATEX FREE • REUSABLE •

- Life-long patented switch mechanism
- Removable internal battery cylinder for easy sterilization / autoclavable
- Meets and exceeds Joint Commission Standards
- Batteries included
- Compatible with all Green System handles

Item	Description	Size	Battery	Qty	\$
5-1991-50	Xenon Handle	Med/Lg	2-C	1	\$178.95
5-1991-52	Xenon Handle	Penlite	2-AA	1	\$196.95
5-1991-78	Xenon Handle	Stubby	2-AA	1	\$177.95
5-1994-07	Xenon Bulb	2.5V	--	1	\$23.95



LED Stainless Steel Handles

Brighter than Halogen Handles

• LATEX FREE • REUSABLE •

- Integrated fiber optics offers a brighter light source and lasts 1,000 times longer than halogen bulbs
- Removable internal battery cylinder for easy sterilization
- Meets and exceeds Joint Commission Standards
- Compatible with all Green System handles

Item	Description	Size	Battery	Qty	\$
5-1995-82	LED Handle	Med/Lg	2-C	1	\$212.95
5-1995-83	LED Handle	Penlite	2-AA	1	\$222.95
5-1995-81	LED Handle	Stubby	2-AA	1	\$212.95

FIBER OPTIC LARYNGOSCOPES • Reusable / MR Conditional



5-4431-30

Emerald® Macintosh & Miller Integrated Blades

Matte Finish Reduces Glare

• LATEX FREE • REUSABLE •

- Bright, focused fiber optic light
- Easy to clean
- Compatible with all Green System handles

Miller Blades

Item	Description	Size	Qty	\$
5-4449-10	Emerald Miller Blade, Premature	00	1	\$96.95
5-4450-20	Emerald Miller Blade, Newborn	0	1	\$96.95
5-4451-30	Emerald Miller Blade, infant	1	1	\$96.95
5-4452-40	Emerald Miller Blade, Child	2	1	\$96.95
5-4453-30	Emerald Miller Blade, Med. Adult	3	1	\$96.95
5-4454-40	Emerald Miller Blade, Large Adult	4	1	\$96.95

Macintosh Blades

Item	Description	Size	Qty	\$
5-4431-10	Emerald Macintosh Blade, Infant	1	1	\$96.95
5-4431-20	Emerald Macintosh Blade, Child	2	1	\$96.95
5-4431-30	Emerald Macintosh Blade, Med. Adult	3	1	\$96.95
5-4431-35	Emerald Macintosh Blade, Ext. Med. Adult	3.5	1	\$96.95
5-4431-40	Emerald Macintosh Blade, Large Adult	4	1	\$96.95



5-4413-30

5-4412-20

5-4411-10

Emerald® Chrome-Plated Handles

Satin Finish

• LATEX FREE • REUSABLE •

- Satin finish, chrome-plated brass
- Lamp supplied with handle
- Green System compatible

Item	Description	Size	Battery	Qty	\$
5-4411-10	Chrome-Plated Handle	Medium	2-C	1	\$65.95
5-4412-20	Chrome-Plated Handle	Penlite	2-AA	1	\$65.95
5-4413-30	Chrome-Plated Handle	Stubby	2-AA	1	\$86.95
5-0235-22	Xenon Replacement Bulb	--	--	6	\$97.95



MR Conditional Laryngoscope Kit

Complete Fiber Optic Kit

• LATEX FREE • REUSABLE •

- Unique design - black handle and gold plated fiber optic clip offers a set that is clearly distinguishable from laryngoscopes used in other departments
- Independently certified to support MR conditions with a static magnetic field of 3-Tesla or less and highest spatial gradient field of 720-Gauss/cm or less
- High intensity xenon bulb provides ultra bright white light
- Powered by low magnetic battery for safety in the MRI suite

Item	Description	Qty	\$
5-5852-30	MR Conditional Laryngoscope Kit Mac Blades: 2, 3, 4; Miller Blades: 1, 2, 3; MRI Hard Anodized Aluminum Med. Handle; Two MRI Battery Packs	1	\$2,029.95
5-5853-30	Replacement Battery Pack	1	\$79.95

MR Conditional • FIBER OPTIC LARYNGOSCOPES



5-5532-03

5-5533-03

MR Conditional Laryngoscopes

Wide Variety of Blade Styles & Sizes

• LATEX FREE • REUSABLE •

- Tested to comply with ASTM standards for MRI conditional devices in up to 3.0 Tesla environments
- 4.0 mm bundle provides bright light
- Stainless steel
- Compatible with all Green System handles

Macintosh American Profile Blades

Item	Description	Size	Qty	\$
5-5531-00	Mac American MR Conditional Blade	0	1	\$157.95
5-5531-01	Mac American MR Conditional Blade	1	1	\$157.95
5-5531-02	Mac American MR Conditional Blade	2	1	\$157.95
5-5531-03	Mac American MR Conditional Blade	3	1	\$157.95
5-5531-35	Mac American MR Conditional Blade	3.5	1	\$157.95
5-5531-04	Mac American MR Conditional Blade	4	1	\$157.95

Macintosh English Profile Blades

Item	Description	Size	Qty	\$
5-5532-01	Mac English MR Conditional Blade	1	1	\$157.95
5-5532-02	Mac English MR Conditional Blade	2	1	\$157.95
5-5532-03	Mac English MR Conditional Blade	3	1	\$157.95
5-5532-04	Mac English MR Conditional Blade	4	1	\$157.95

Miller Blades

Item	Description	Size	Qty	\$
5-5533-00	Miller MR Conditional Blade	0	1	\$157.95
5-5533-01	Miller MR Conditional Blade	1	1	\$157.95
5-5533-02	Miller MR Conditional Blade	2	1	\$157.95
5-5533-03	Miller MR Conditional Blade	3	1	\$157.95
5-5533-04	Miller MR Conditional Blade	4	1	\$157.95

Wisconsin Blades

Item	Description	Size	Qty	\$
5-5534-02	Wisconsin MR Conditional Blade	2	1	\$157.95
5-5534-03	Wisconsin MR Conditional Blade	3	1	\$157.95
5-5534-04	Wisconsin MR Conditional Blade	4	1	\$157.95

MR Conditional Laryngoscopes

Most Popular MR Handles

• LATEX FREE • REUSABLE •

- Tested to comply with ASTM standards for MRI conditional devices in up to 3.0 Tesla environments or less and highest spatial gradient field of 720-Gauss/cm or less
- Batteries sold separately
- Hazmat fee applied



5-5501-04



5-5501-02

Item	Description	Size	Qty	\$
5-5500-11	MR Conditional Handle	Stubby	1	\$403.95
5-5500-09	MR Conditional Handle	Medium	1	\$408.95
5-5501-02	Low Magnetic Lithium Battery	-	2	\$383.95
5-5501-04	Fiber Optic Halogen Lamp	-	5	\$109.95
5-5531-47	MR Conditional Laryngoscope Kit Mac Blades: 2, 3, 4; Miller Blades: 0, 1, 2, 3; Med. Handle; Plastic Case	-	1	\$2,199.95



5-5531-47



5-5500-11

5-5500-09



Macintosh American & English LED Conventional Blades
Fits on All Standard Hook-On Handles

- LATEX FREE • REUSABLE •
- Made of surgical stainless steel
- Soft matte finish eliminates glare
- Lamps emit focused illumination to prevent light splay

Macintosh American LED Blades

Item	Description	Size	Qty	\$
5-5852-00	Mac American LED Blade, Neonate	0	1	\$46.95
5-5852-01	Mac American LED Blade, Infant	1	1	\$46.95
5-5852-02	Mac American LED Blade, Child	2	1	\$46.95
5-5852-03	Mac American LED Blade, Med. Adult	3	1	\$46.95
5-5852-35	Mac American LED Blade, Med. Ext. Adult	3.5	1	\$46.95
5-5852-04	Mac American LED Blade, Large Adult	4	1	\$46.95

Macintosh English LED Blades

Item	Description	Size	Qty	\$
5-5851-00	Mac English LED Blade, Neonate	0	1	\$46.95
5-5851-01	Mac English LED Blade, Infant	1	1	\$46.95
5-5851-02	Mac English LED Blade, Child	2	1	\$46.95
5-5851-03	Mac English LED Blade, Med. Adult	3	1	\$46.95
5-5851-04	Mac English LED Blade, Large Adult	4	1	\$46.95
5-5851-05	Mac English LED Blade, X-Large Adult	5	1	\$46.95
5-5853-03	Mac English LED Blade, Left Hand Med. Adult	3	1	\$46.95



Macintosh & Miller English Profile Blades
Satin Finish Eliminates Glare

- LATEX FREE • REUSABLE •
- Macintosh blade has soft gentler curve and the flange extends all the way down to the distal tip
- Miller blades have all lamps on the left side in user position
- Pre-focused lamp
- Made of surgical stainless steel

Macintosh English Blades

Item	Description	Size	Qty	\$
5-5051-00	Mac English Blade, Neonate	0	1	\$22.95
5-5051-01	Mac English Blade, Infant	1	1	\$22.95
5-5051-02	Mac English Blade, Child	2	1	\$22.95
5-5051-03	Mac English Blade, Med. Adult	3	1	\$22.95
5-5051-04	Mac English Blade, Large Adult	4	1	\$22.95
5-5051-05	Mac English Blade, X-Large Adult	5	1	\$22.95

Miller English Blades

Item	Description	Size	Qty	\$
5-5061-00	Miller English Blade, Neonate	0	1	\$22.95
5-5061-01	Miller English Blade, Infant	1	1	\$22.95
5-5061-02	Miller English Blade, Child	2	1	\$22.95
5-5061-03	Miller English Blade, Med. Adult	3	1	\$22.95
5-5061-04	Miller English Blade, Large Adult	4	1	\$22.95

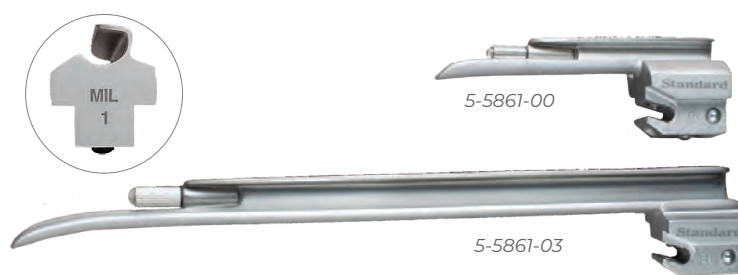
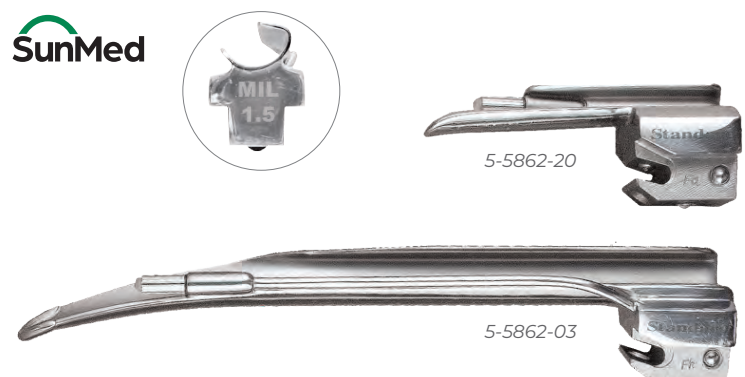

Miller American & English LED Conventional Blades
Fits on All Standard Hook-On Handles

- LATEX FREE • REUSABLE •
- Made of surgical stainless steel
- Soft matte finish eliminates glare
- Lamps emit focused illumination to prevent light splay

Miller American LED Blades

Item	Description	Size	Qty	\$
5-5862-20	Miller American LED Blade, Premature	00	1	\$46.95
5-5862-00	Miller American LED Blade, Neonate	0	1	\$46.95
5-5862-01	Miller American LED Blade, Infant	1	1	\$46.95
5-5862-15	Miller American LED Blade, Small Child	1.5	1	\$46.95
5-5862-02	Light on Right, Miller American, Child	2	1	\$46.95
5-5862-03	Light on Right, Miller American, Med. Adult	3	1	\$46.95
5-5862-04	Light on Right, Miller American, Large Adult	4	1	\$46.95

Miller English LED Blades

Item	Description	Size	Qty	\$
5-5861-00	Miller English LED Blade, Neonate	0	1	\$46.95
5-5861-01	Miller English LED Blade, Infant	1	1	\$46.95
5-5861-02	Miller English LED Blade, Child	2	1	\$46.95
5-5861-03	Miller English LED Blade, Med. Adult	3	1	\$46.95
5-5861-04	Miller English LED Blade, Large Adult	4	1	\$46.95

GreenLine® Polio English Blade
Offset Blade Suitable for Difficult Intubations

- LATEX FREE • REUSABLE •
- Modified Macintosh English blade for indirect laryngoscopy angled at 120°
- Blade is offset from handle at an obtuse angle to allow intubation of patients on respirators, in body jackets, as well as other difficult intubation scenarios
- Frosted lamp provides defused illumination without shadows
- Made of surgical stainless steel
- Green System compatible

Item	Description	Size	Qty	\$
5-3077-53	Polio English Blade, Med. Adult	3	1	\$40.95





Macintosh & Miller American Profile Blades
Standard & Waterproof Blades Available

• LATEX FREE • REUSABLE •

- Made of surgical stainless steel
- Macintosh blade spatula has a smooth and gentle curve extending from lock to tip
- Miller blade has a reduced flange to help minimize trauma
- Waterproof blade has extended 5 year warranty and may be immersed in liquid disinfectant
- Standard blade has 1 year warranty

Standard Macintosh American Blades

Item	Description	Size	Qty	\$
5-5052-00	Mac American Standard Blade, Neonate	0	1	\$22.95
5-5052-01	Mac American Standard Blade, Infant	1	1	\$22.95
5-5052-02	Mac American Standard Blade, Small Child	2	1	\$22.95
5-5052-03	Mac American Standard Blade, Child	3	1	\$22.95
5-5052-35	Mac American Standard Blade, Med. Adult	3.5	1	\$22.95
5-5052-04	Mac American Standard Blade, Large Adult	4	1	\$22.95

Waterproof Macintosh American Blades

Item	Description	Size	Qty	\$
5-5401-00	Mac American Waterproof Blade, Neonate	0	1	\$29.95
5-5401-01	Mac American Waterproof Blade, Infant	1	1	\$29.95
5-5401-02	Mac American Waterproof Blade, Small Child	2	1	\$29.95
5-5401-03	Mac American Waterproof Blade, Child	3	1	\$29.95
5-5401-35	Mac American Waterproof Blade, Med. Adult	3.5	1	\$29.95
5-5401-04	Mac American Waterproof Blade, Large Adult	4	1	\$29.95

Standard Miller American Blades

Item	Description	Size	Qty	\$
5-5062-20	Miller American Standard Blade, Premature	00	1	\$22.95
5-5062-00	Miller American Standard Blade, Neonate	0	1	\$22.95
5-5062-01	Miller American Standard Blade, Infant	1	1	\$22.95
5-5062-15	Miller American Standard Blade, Small Child	1.5	1	\$22.95
5-5062-02	Miller American Standard Blade, Child	2	1	\$22.95
5-5062-03	Miller American Standard Blade, Med. Adult	3	1	\$22.95
5-5062-04	Miller American Standard Blade, Large Adult	4	1	\$29.95

Waterproof Miller American Blades

Item	Description	Size	Qty	\$
5-5403-20	Miller American Waterproof Blade, Premature	00	1	\$29.95
5-5403-00	Miller American Waterproof Blade, Neonate	0	1	\$29.95
5-5403-01	Miller American Waterproof Blade, Infant	1	1	\$29.95
5-5403-15	Miller American Waterproof Blade, Small Child	1.5	1	\$29.95
5-5403-02	Miller American Waterproof Blade, Child	2	1	\$29.95
5-5403-03	Miller American Waterproof Blade, Med. Adult	3	1	\$29.95
5-5403-04	Miller American Waterproof Blade, Large Adult	4	1	\$22.95



Left Handed Macintosh English Blade
Lamp is Located on the Right Side in User Position

• LATEX FREE • REUSABLE •

- Flange extends all the way down to distal tip
- Soft matte finish eliminates glare
- Made of surgical stainless steel

Item	Description	Size	Qty	\$
5-5053-03	Left Handed Mac English Blade, Adult	3	1	\$32.95



Wis-Hipple Miller American Blades
Designed Primarily for Use with Infants

• LATEX FREE • REUSABLE •

- Wisconsin-modified blade with a straight spatula
- Flange tends to be straighter than Wisconsin blade and runs parallel with the spatula
- Wider, flat tip is well-adapted to lifting the epiglottis
- Frosted lamp provides diffused illumination without a shadow
- Made of surgical stainless steel



Item	Description	Size	Qty	\$
5-5057-20	Wis-Hipple American Blade, Premature	00	1	\$22.95
5-5057-00	Wis-Hipple American Blade, Newborn	0	1	\$22.95
5-5057-01	Wis-Hipple American Blade, Infant	1	1	\$22.95
5-5057-15	Wis-Hipple American Blade, Small Child	1.5	1	\$22.95

Cranwall™ Miller American Blades
Designed to Help Decrease Potential Tooth Damage

• LATEX FREE • REUSABLE •

- Reduced flange allows easier insertion through a restricted opening, such as arthritic jaw or facial burns
- Flange removed directly below the light carrier
- Can easily be used as a left handed straight blade
- Frosted lamp provides diffused illumination without a shadow
- Made of surgical stainless steel



Item	Description	Size	Qty	\$
5-5063-00	Cranwall Miller American Blade, Neonate	0	1	\$22.95
5-5063-01	Cranwall Miller American Blade, Infant	1	1	\$22.95
5-5063-02	Cranwall Miller American Blade, Child	2	1	\$22.95
5-5063-03	Cranwall Miller American Blade, Med. Adult	3	1	\$22.95



Robertshaw Miller English Blade
Better Depth Judgment & Less Trauma with Binocular Vision

• LATEX FREE • REUSABLE •

- Designed specifically for infants and children
- Spatula is gently curved over the distal third and can indirectly lift the epiglottis similar to a Macintosh blade
- Clear lamp provides bright illumination
- Made of surgical stainless steel



Item	Description	Size	Qty	\$
5-5077-00	Robertshaw Miller English Blade, Newborn	0	1	\$45.95
5-5077-01	Robertshaw Miller English Blade, Infant	1	1	\$45.95



5-5057-03



Wisconsin Miller American Blade
Frosted Lamp Provides Diffused Illumination, No Shadows

- LATEX FREE • REUSABLE •
- Straight spatula design with flange that expands slightly toward distal portion of blade increases visual field to help prevent potential trauma
- Distal portion of blade is wider and formed slightly to right, making it well-adapted to lifting the epiglottis
- Made of surgical stainless steel

Item	Description	Size	Qty	\$
5-5057-02	Wisconsin Miller American Blade, Child	2	1	\$22.95
5-5057-03	Wisconsin Miller American Blade, Med. Adult	3	1	\$22.95
5-5057-04	Wisconsin Miller American Blade, Large Adult	4	1	\$22.95



5-5079-02



Seward Miller English Blade
For Use on Infants & Children

- LATEX FREE • REUSABLE •
- Originally produced as an infant blade, it is now available to fit older children
- Clear lamp provides bright illumination
- Made of surgical stainless steel

Item	Description	Size	Qty	\$
5-5079-01	Seward Miller English Blade, Infant	1	1	\$42.95
5-5079-02	Seward Miller English Blade, Child	2	1	\$42.95



5-3078-01



Miller Port American Blade
Integrated Tube Permits Delivery of Oxygen or Other Gas During Intubation

- LATEX FREE • REUSABLE •
- Specifically designed to perform laryngoscope and intubation with reduced risk of hypoxia
- Frosted lamp provides diffused illumination without shadows
- Made of surgical stainless steel

Item	Description	Size	Qty	\$
5-3078-00	Miller Port American Blade, Newborn	0	1	\$42.95
5-3078-01	Miller Port American Blade, Infant	1	1	\$42.95



Snow Miller American Blade
Curves Back from Distal End for Convenient Visual Field

- LATEX FREE • REUSABLE •
- Combined Miller spatula and Wis-Foregger flange design can reduce trauma during intubation, especially for use with a cuffed tube
- Frosted lamp provides diffused illumination without shadows
- Made of surgical stainless steel

Item	Description	Size	Qty	\$
5-3069-03	Snow Miller American Blade, Med. Adult	3	1	\$29.95



Sun-Flex™ Macintosh English Blades
Non-Pinching Flexible Tip

- LATEX FREE • REUSABLE •
- English channel helps visualization of the epiglottis
- Designed to enable precise control to elevate the epiglottis
- Satin finish virtually eliminates reflection and glare
- Reflector lamp provides extra bright illumination
- Made of surgical stainless steel

Item	Description	Size	Qty	\$
5-5082-02	Sun-Flex Mac English Blade, Child	2	1	\$164.95
5-5082-03	Sun-Flex Mac English Blade, Med. Adult	3	1	\$164.95
5-5082-04	Sun-Flex Mac English Blade, Large Adult	4	1	\$164.95

Sun-Flex Macintosh English Blade Kit

Item	Kit Includes	Qty	\$
5-5082-42	Medium Handle (5-0237-03) Replacement Lamp (5-0234-14) Sun-Flex Mac English Blades: 3 (5-5082-03), 4 (5-5082-04) Hard Case (8-1050-77)	1	\$279.95



5-5082-03

5-5082-42

Flangeless Macintosh American Blades
Bizzarri-Giuffrida

- LATEX FREE • REUSABLE •
- Absent upper flange on curved blade is effective for use on patients with limited mouth opening, prominent incisors, receding mandible, short thick neck or larynx in an extreme anterior anatomical position
- Design greatly reduces the potential trauma during laryngoscopy
- Frosted lamp provides defused illumination without shadows
- Made of surgical stainless steel

Item	Description	Size	Qty	\$
5-3072-03	Flangeless Mac American Blade, Med. Adult	3	1	\$41.95
5-3072-04	Flangeless Mac American Blade, Large Adult	4	1	\$41.95



5-3072-03

Blechman Macintosh American Blade
Angled Tip Elevates Epiglottis in Supine Patients

- LATEX FREE • REUSABLE •
- Tongue is swept to the left allowing the blade to tip upward for effective viewing
- Clear lamp provides bright illumination
- Made of surgical stainless steel

Item	Description	Size	Qty	\$
5-3084-03	Blechman Mac American Blade, Med. Adult	3	1	\$40.95





Reduced Flange Macintosh English Blades

Increased Maneuverability & Reduced Pressure on Teeth

- **LATEX FREE** • **REUSABLE** •
- Channel extends from heel to mid-blade for improved visualization of chords
- Channel design helps guide endotracheal tube insertion
- Clear reflector lamp delivers four times brighter illumination than frosted lamps
- Made of surgical stainless steel

Item	Description	Size	Qty	\$
5-3071-02	Reduced Flange Mac English Blade, Child	2	1	\$29.95
5-3071-03	Reduced Flange Mac English Blade, Med. Adult	3	1	\$29.95
5-3071-35	Reduced Flange Mac English Blade, Ext. Med. Adult	3.5	1	\$29.95
5-3071-04	Reduced Flange Mac English Blade, Large Adult	4	1	\$29.95



Improved View Macintosh American Blades

Channel Aids in Endotracheal Tube Insertion

- **LATEX FREE** • **REUSABLE** •
- Channel extends from heel to mid-blade for improved visualization of chords
- Clear reflector lamp delivers four times brighter illumination than frosted lamps
- Made of surgical stainless steel

Item	Description	Size	Qty	\$
5-5054-02	Improved View Mac English Blade, Child	2	1	\$29.95
5-5054-03	Improved View Mac English Blade, Med. Adult	3	1	\$29.95
5-5054-35	Improved View Mac English Blade, Ext. Med. Adult	3.5	1	\$29.95
5-5054-04	Improved View Mac English Blade, Large Adult	4	1	\$29.95



Improved View Macintosh English Blades

For Enhanced Endotracheal Tube Insertion

- **LATEX FREE** • **REUSABLE** •
- Channel extends from heel to mid-blade for improved visualization of chords
- Clear reflector lamp delivers four times brighter illumination than frosted lamps
- Made of surgical stainless steel

Item	Description	Size	Qty	\$
5-5046-02	Improved View Mac English Blade, Child	2	1	\$29.95
5-5046-03	Improved View Mac English Blade, Med. Adult	3	1	\$29.95
5-5046-35	Improved View Mac English Blade, Ext. Med. Adult	3.5	1	\$29.95
5-5046-04	Improved View Mac English Blade, Large Adult	4	1	\$29.95



Complete Intubation Kits

Pre-Packed, Ready-to-Go!

- **LATEX FREE** •
- Available with conventional, fiber optic or disposable laryngoscopes
- All components in original sterile packaging



- KIT INCLUDES:**
- 8 Color Coded Guedel Airways (size: 40-100 mm)
 - 4 Nasopharyngeal Airways (sizes 20, 24, 28, 32 Fr)
 - 2 Uncuffed ET Tubes (sizes 2.5, 4 mm)
 - 8 Cuffed ET Tubes (sizes 5-10 mm)
 - 1 ET Tube Introducer (Bougie) with Coudé tip
 - 1 Adult Stylette
 - 1 Adult Magill Forceps
 - 1 Pediatric Magill Forceps
 - 4 Packets of Sterile Lubricating Jelly
 - 1 Syringe (10 mL)
 - 1 Nylon Case
 - 2 "AA" & "C" Batteries (if applicable)
 - Replacement laryngoscope lamps (if applicable)

- LARYNGOSCOPE HANDLES & BLADES:**
- 1 Penlite Laryngoscope Handle
 - 1 Medium Laryngoscope Handle
 - 5 Miller Laryngoscope Blades (sizes 0-4)
 - 4 Macintosh Laryngoscope Blades (sizes 1-4)

Item	Description	Qty	\$
8-1050-85	Conventional Blade Kit	1	\$329.95

CONVENTIONAL LARYNGOSCOPES • Handles

SunMed



Stainless Steel Conventional Handles

Waterproof

• LATEX FREE • REUSABLE •

- Handles may be immersed in disinfectant without removing batteries
- Batteries are not included

Item	Description	Size	Battery	Qty	\$
5-0237-93	Stainless Steel Handle	Medium	2-C	1	\$46.95
5-0237-91	Stainless Steel Handle	Penlite	2-AA	1	\$47.95
5-0237-92	Stainless Steel Handle	Stubby	2-AA	1	\$49.95
5-0237-96	Stainless Steel Handle	Micro Mini	1-Lithium	1	\$56.95

5-0237-96 5-0237-92 5-0237-91 5-0237-93

SunMed



Chrome Plated Conventional Handles

Chrome Plated Brass

• LATEX FREE • REUSABLE •

- Handles may be immersed in disinfectant without removing batteries
- Batteries are not included

Item	Description	Size	Battery	Qty	\$
5-0237-03	Chrome Plated Handle	Medium	2-C	1	\$29.95
5-0237-01	Chrome Plated Handle	Penlite	2-AA	1	\$29.95
5-0237-02	Chrome Plated Handle	Stubby	2-AA	1	\$36.95
5-0237-05	Chrome Plated Handle	Large	2-D	1	\$37.95
5-0237-08	Chrome Plated Handle	Mini	1-Lithium	1	\$39.95

5-0237-08 5-0237-02 5-0237-01 5-0237-03 5-0237-05

SunMed



LED Replacement Lamps

For Use With All SunMed Conventional Handles

• LATEX FREE • DISPOSABLE •

- Meets stringent manufacturing controls
- Frosted lamps provide diffused illumination without shadows
- Clear lamps provide bright illumination

Item	Description	Qty	\$
5-0234-01	Small Frosted Replacement Lamp	10	\$29.95
5-0234-04	Large Frosted Replacement Lamp	10	\$29.95
5-0235-01	Small Clear Replacement Lamp	10	\$34.95
5-0235-04	Large Clear Replacement Lamp	10	\$34.95
5-0234-21	Small LED Replacement Lamp	1	\$29.95
5-0234-24	Large LED Replacement Lamp	1	\$29.95
5-0234-14	Large Reflector Replacement Lamp	5	\$34.95

5-0234-24 5-0235-04 5-0234-21 5-0235-01 5-0234-14

Handles • CONVENTIONAL LARYNGOSCOPES

Chrome Plated Conventional Handles

High Quality Chrome Plated Brass

• LATEX FREE • REUSABLE •

- Compatible with all standard conventional blades
- Durable and reliable

Item	Description	Size	Battery	Qty	\$
5-8710-00	Chrome Plated Handle	Pediatric	1-N	1	\$45.95
5-8621-00	Chrome Plated Handle	Medium	2-C	1	\$18.95
5-8720-00	Chrome Plated Handle	Stubby	2-AA	1	\$36.95
5-0240-90	N-Batteries	-	N	2	\$9.95
5-0086-22	Frosted Replacement Lamp	Small	-	6	\$26.95
5-0086-23	Frosted Replacement Lamp	Large	-	6	\$26.95



5-8621-00 5-8620-00 5-8720-00 5-8710-00

RUSCH
A TELEFLEX COMPANY

Chrome Plated Conventional Handles

Knurled Finish for Sure Grip

• LATEX FREE • REUSABLE •

- Universal design allows handle to accept any ASTM standard blade
- Crafted from durable chrome plated brass

Item	Description	Size	Battery	Qty	\$
5-6020-00	Chrome Plated Handle	Large	2-D	1	\$232.95
5-6030-00	Chrome Plated Handle	Medium	2-C	1	\$70.95
5-6040-00	Chrome Plated Handle	Penlite	2-AA	1	\$98.95
5-6030-50	Chrome Plated Handle	Stubby	2-AA	1	\$270.95
5-0235-01	Clear Replacement Lamp	Small	-	10	\$39.95
5-0235-04	Clear Replacement Lamp	Large	-	10	\$39.95



5-6020-00 5-6030-00 5-6040-00 5-6030-50

WelchAllyn

Chrome Plated Conventional Handles

O-Ring Creates Watertight Seal to Keep Moisture Out

• LATEX FREE • REUSABLE •

- Chrome Plated Brass
- Waterproof
- Handles may be immersed in disinfectant without removing batteries

Item	Description	Size	Battery	Qty	\$
5-1450-00	Chrome Plated Handle	Medium	2-C	1	\$44.95
5-1451-01	Chrome Plated Handle	Penlite	2-AA	1	\$39.95

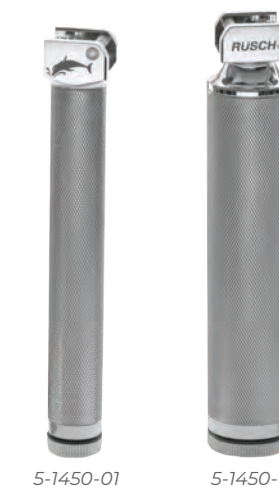

5-1450-01 5-1450-00

RUSCH
A TELEFLEX COMPANY
Dolphin

CONVENTIONAL LARYNGOSCOPES • Macintosh & Miller



Macintosh & Miller Conventional Blades Flange Reduced for Less Trauma

• LATEX FREE • REUSABLE •

- Curved beak or tip was extended to improve lifting of the epiglottis
- Macintosh blade has a curved spatula, Miller blade has a straight spatula
- Satin finish, stainless steel
- Interchangeable with other conventional brands
- 100% autoclavable

Macintosh Conventional Blades

Item	Description	Size	Qty	\$
5-0086-01	Macintosh Conventional Blade, Infant	1	1	\$35.95
5-0086-02	Macintosh Conventional Blade, Child	2	1	\$35.95
5-0086-03	Macintosh Conventional Blade, Adult	3	1	\$35.95
5-0086-35	Macintosh Conventional Blade, Med. Adult	3.5	1	\$40.95
5-0086-04	Macintosh Conventional Blade, Large Adult	4	1	\$40.95

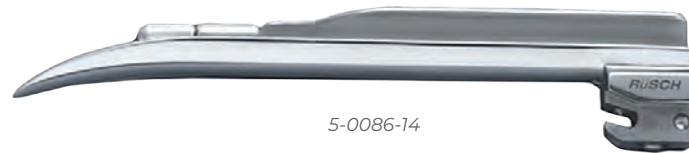

Wisconsin Conventional Blades

Provides Increased Visual Field

• LATEX FREE • REUSABLE •

- Straight spatula and flange that expands slightly towards the distal portion of the blade
- Satin finish, stainless steel
- Interchangeable with other conventional brands
- 100% autoclavable

Item	Description	Size	Qty	\$
5-0086-11	Wisconsin Conventional Blade, Infant	1	1	\$37.95
5-0086-12	Wisconsin Conventional Blade, Child	2	1	\$37.95
5-0086-13	Wisconsin Conventional Blade, Adult	3	1	\$37.95
5-0086-14	Wisconsin Conventional Blade, Large Adult	4	1	\$37.95



Improved View Macintosh Conventional Blades

Mid-Portion Concave Allows for Superior Visualization

• LATEX FREE • REUSABLE •

- Curved beak or tip was extended to improve lifting of the epiglottis
- Curved spatula
- Satin finish, stainless steel
- Interchangeable with other conventional brands
- 100% autoclavable

Item	Description	Size	Qty	\$
5-1967-00	IV Mac Conventional Blade, Premature	0	1	\$63.95
5-1967-10	IV Mac Conventional Blade, Infant	1	1	\$63.95
5-1967-20	IV Mac Conventional Blade, Child	2	1	\$63.95
5-1967-30	IV Mac Conventional Blade, Adult	3	1	\$63.95
5-1967-35	IV Mac Conventional Blade, Med. Adult	3.5	1	\$63.95
5-1967-40	IV Mac Conventional Blade, Large Adult	4	1	\$63.95

Macintosh & Miller • CONVENTIONAL LARYNGOSCOPES

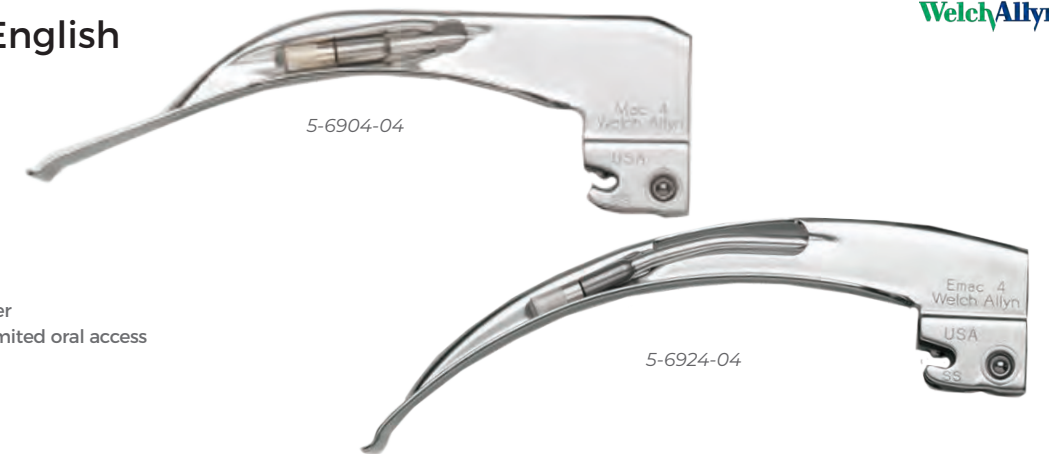

Macintosh American & English Conventional Blades

Single-Piece Stainless Steel Blade

• LATEX FREE • REUSABLE •

- Design incorporates a gentle, continuous curve from the tip to the proximal end
- Curve is compressed into the vallecula and the blade lifted, indirectly raising the epiglottis
- Reduced proximal blade height results in a lower profile that assists in intubating patients with limited oral access

Macintosh American Conventional Blades

Item	Description	Size	Qty	\$
5-6904-01	Mac American Conv. Blade, Infant	1	1	\$139.95
5-6904-02	Mac American Conv. Blade, Child	2	1	\$150.95
5-6904-03	Mac American Conv. Blade, Med. Adult	3	1	\$109.95
5-6904-04	Mac American Conv. Blade, Large Adult	4	1	\$109.95

Macintosh English Conventional Blades

Item	Description	Size	Qty	\$
5-6924-01	Mac English Conv. Blade, Infant	1	1	\$157.95
5-6924-02	Mac English Conv. Blade, Child	2	1	\$157.95
5-6924-03	Mac English Conv. Blade, Med. Adult	3	1	\$150.95
5-6924-04	Mac English Conv. Blade, Large Adult	4	1	\$150.95



Miller Conventional Blades

Modified Design Improves Functionality and Field of View

• LATEX FREE • REUSABLE •

- Blade is flattened so the patient's tongue would be swept aside, rather than compressed
- Flat base helps hold the tongue out of the field of view
- Overall field of view increased by modifying the cross-sectional area of the blade without altering width or height

Item	Description	Size	Qty	\$
5-6804-00	Miller Conventional. Blade, Neonate	0	1	\$119.95
5-6804-01	Miller Conventional. Blade, Infant	1	1	\$119.95
5-6804-02	Miller Conventional. Blade, Child	2	1	\$109.95
5-6804-03	Miller Conventional. Blade, Med. Adult	3	1	\$109.95
5-6804-04	Miller Conventional. Blade, Adult	4	1	\$119.95



Phillips Conventional Blades

Integrates the Preferred Straight Jackson Blade

• LATEX FREE • REUSABLE •

- Flange reduced for less trauma
- Curved beak or tip was extended to improve lifting of the epiglottis
- Straight spatula
- Satin finish, stainless steel
- Interchangeable with other conventional brands
- 100% autoclavable

Item	Description	Size	Qty	\$
5-0086-51	Phillips Conventional Blade, Pediatric	1	1	\$39.95
5-0086-61	Phillips Conventional Blade, Adult	2	1	\$39.95





8-1053-63

Peripheral Nerve Stimulators

Qualitative Nerve Stimulation

• LATEX FREE • REUSABLE •

SunStim™ Pro

LED Screen Displays Functionality

- Ergonomic, compact shape fits comfortably in hand
- Easy-to-Read illuminated digital screen displays DBS, Twitch, Tetanus, TOF, current intensity and battery life
- Clearly visible, finger-controlled front face buttons
- Side switch to increase and decrease level of stimulation
- Removable silicone wrap enhances grip, helps protect device

SunStim™ Plus

Enhanced Functionality

- Features two 60 milliamp burst simulation at 50 Hz, separated by 0.75 seconds
- Develops optimal output to ensure supramaximal stimulation: Output current is fully adjustable from 0-70 mA
- Features 50 and 100 Hz Tetanus, TOF and DBS

SunStim™

Affordable Nerve Stimulator

- Consistent voltage stimulator for monitoring neuromuscular block
- Evaluates muscle relaxant dosage during surgery and recovery

All three devices come ready to use! Includes: instruction manual, battery, ball electrodes, 6' leads with clips and a one year warranty.

Item	Description	Qty	\$
8-1053-63	SunStim Pro Peripheral Nerve Stimulator	1	\$259.95
8-1053-62	SunStim Plus Peripheral Nerve Stimulator	1	\$229.95
8-1053-60	SunStim Peripheral Nerve Stimulator	1	\$219.95



8-1053-62



8-1053-60



Accessories



8-1053-GR Gray
8-1053-BL Blue
8-1053-PL Purple
8-1053-FS Fuchsia
8-1053-PK Pink
8-1053-RD Red
8-1053-OR Orange



8-1053-GN Green

8-1053-TL Teal

Wrap Your Pro for a Better Grip!



8-1051-78

8-1051-79

8-1053-76

8-1053-85 / 8-1053-95

8-1053-65

Item	Description	Qty	\$
See item numbers above	Silicone Wraps for SunStim Pro	1	\$19.95
8-1053-76	Stim Ball Electrodes & Hollow Pin	1	\$29.95
8-1051-78	6' Lead Snap & Shield Pin	1	\$32.95
8-1051-79	6' Lead Clip & Shield Pin	1	\$32.95
8-1053-81	SunStim Overlay	1	\$14.95
8-1053-82	SunStim Plus Overlay	1	\$14.95
8-1053-85	Metal Pole Mount Bracket for SunStim & SunStim Plus	1	\$133.95
8-1053-65	Polycarbonate Pole Mount Bracket for SunStim & SunStim Plus	1	\$55.95
8-1053-95	Pole Mount Bracket for SunStim Pro	1	\$133.95

Specifications	SunStim™	SunStim™ Plus	SunStim™ Pro
Stimulus Pulse	Square wave monophasic pulses	Square wave monophasic pulses	200 Microseconds/Square Wave Monophasic
Tetanus	100 Hz	50 Hz or 100 Hz	50 Hz or 100 Hz
DBS	None	Two (2) ms bursts of 50 Hz separated by 0.75 seconds (750 milliseconds)	Two (2) ms bursts of 50 Hz separated by 0.75 seconds (750 milliseconds)
Twitch	One (1) pulse per second	One (1) pulse per second	One (1) pulse per second
TOF	Four (4) pulses in a 2 second period	Four (4) pulses in a 2 second period	Four (4) pulses in a 2 second period
Output Current	Adjustable 0-70mA	Adjustable 0-70mA	Adjustable 0-70mA
Battery Indicator	Solid green light = ON / Flashing = Replace	Solid green light = ON / Flashing = Replace	Battery symbol on LCD screen and green battery light will flash simultaneously when battery voltage is low
Audible & Visual Indicator	Audible & red flashing light when pulse is generated	Audible & red flashing light when pulse is generated	Flash yellow when pulse is generated; steady green, when the unit is turned ON
Power Source	One (1) 9 Volt alkaline battery	One (1) 9 Volt alkaline battery	One (1) 9 Volt alkaline battery
Size	1.10" x 2.42" x 3.88"	1.10" x 2.42" x 3.88"	4.53" x 2.46" x 1.02"
Weight	0.25 lb	0.25 lb	0.25 lb
Warranty	Limited one (1) year parts and labor	Limited one (1) year parts and labor	Limited one (1) year parts and labor



8-4501-10



8-4501-50



8-4501-55



8-4501-56

Stimpod Nerve Stimulators

Nerve Blocking & Location Models

• LATEX FREE • REUSABLE •

- Clear, concise diagnostic screen
- Real time feedback of the actual waveform delivered
- Auto-sensing cables automatically switch stimulation current from mapping probe to needle
- Proximity indicator provides audible and visual feedback when target current and pulse ranges are reached
- Linear and customized non-linear progression of the current and pulse width settings
- Includes monitoring cables and durable plastic carrying case

Stimpod NMS410 8-4501-10

- Designed for precision nerve location in regional anesthesia
- Nerve Mapping Probe allows transcutaneous mapping of nerves prior to needle nerve location, improving accuracy of nerve blocks in a fraction of the time

Stimpod NMS450 8-4501-50

- Provide dual functionality with both precision nerve location and Neuromuscular Blocking Agent monitoring
- 3D accelerometer to accurately and continuously provide TOF, Double Burst and Post Tonic Count ratios

Item	Description	Qty	\$
8-4501-10	NMS410 Peripheral Nerve Stimulator & Nerve Locator	1	\$1,050.95
8-4501-50	NMS450 Peripheral Nerve Stimulator w/ Neuromuscular Blocking Agent Monitoring	1	\$1,265.95
8-4501-55	IV Pole Mount	1	\$126.95
8-4501-56	Anti-Theft Pole Mount w/ Swivel & Tilt	1	\$310.95



Anesthesia Associates, Inc.



FUNCTIONS INCLUDE

- Twitch, 1 of 8 sec, repeating
- TOF, repeating
- Tetanus - 50 Hz & 100 Hz
- ON & Low Battery indicator
- Pulse generated LED indicator
- Selected function LED indicators
- Adjustable output voltage control knob



Peripheral Nerve Stimulator

Qualitative Monitoring

• LATEX FREE • REUSABLE •

- Fully adjustable output voltage
- Automatic feature repeat
- User-friendly controls with indicator LEDs
- ALL functions are selectable from front touch panel
- Sealed front membrane panel
- Use with ball electrodes or leads sets (included) as required
- 9v battery with easy battery access
- Handheld ergonomic design with non-slip rubber sides
- Light-weight, yet rugged construction
- Proudly made in the USA

Item	Description	Qty	\$
8-0200-01	Nerve Stimulator w/ Ball Electrodes, Alligator Clips, Zip Case	1	\$298.95
8-1050-57	54" Leads w/ Alligator Clips	1	\$44.95
8-1050-58	54" Leads w/ Snaps	1	\$34.95
8-1050-50	54" Extension Leads	1	\$65.95
8-0010-60	Ball Electrode Set	1	\$24.95



ToFscan® Neuromuscular Transmission Monitor

Quantitative Monitoring of the Neuromuscular Blockage

• LATEX FREE • REUSABLE •

3D ACCELEROMETRY

- Provides a realistic and complete measurement of muscle response
- Objective results for the quantitative stimulation modes
- Provides the most reliable way to ensure the absence of residual neuromuscular block
- TOF: T4/T1 & T4/Tref Count
- TPC: Count
- DBS: Count

OPTIMAL THUMB POSITION

- Adult thumb movement (contracting adductor pollicis)
- Does not require calibration
- Shape of the thumb sensor designed to ensure accurate results accuracy while remaining easy to use

SIMPLE & ERGONOMIC

- Simple to use
- Operable by plug or battery
- Autonomous and mobile device
- Can be securely clamped to bed rails
- ATP mode ensures simplified and continuous monitoring of the blockage, from induction to the complete reversal of the patient



Item	Description	Qty	\$
8-8856-00	ToFscan Kit: Monitor, AC Power Charger, Clamp, Hand Sensor, Cable Support & Manual	1	\$2,200.95
8-8858-00	Hand Sensor & Electrode Connector (3M)	1	\$590.95
8-8859-00	Optical Serial RS232 Cable (1M)	1	\$220.95
8-8860-00	AC Power Supply/Charger	1	\$85.95
8-8861-00	Pole Fixing Clamp Monitor Holder, 20-60mm diameter	1	\$150.95
8-8863-00	Cable Support Holder	1	\$70.95
8-8864-00	Additional User Manual	1	\$15.95
8-8865-00	Double-sided Sticker for Eyebrow Sensor	96	\$66.95
8-8866-00	Carrying Case for ToFscan & Accessories	1	\$145.95

Specifications	TOF Scan
DBS	3.3, 3.2
Tetanus	50 Hz
TOF	Programmable from 15 seconds - 15 minutes; automatic TOF; recordable
ST	0.1 Hz, 1 Hz
PTC	TOF + PTC
ATP	Automatic TOF - PTC
Output Current	Adjustable from 20-60mA
Power Source	Battery / AC Power
Functionality Indicators	Illumination and audible options



6-1030-50

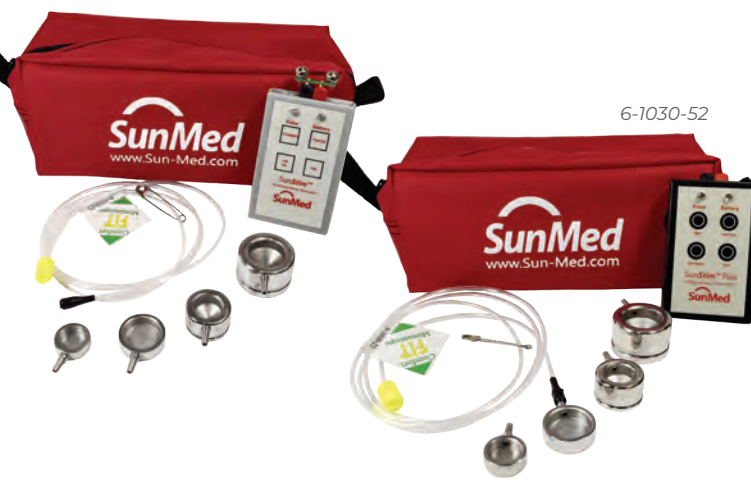

6-1030-52

CRNA Clinical Training Kit Essential Tools for Anesthesia Professionals

• LATEX FREE • REUSABLE •

- Essential diagnostic tools for anesthesia clinicians in training
- Includes: one of three nerve stimulators, monoscope and four chest pieces with double adhesive disks
- Excellent for residency work and beyond at a reasonable student price
- Durable canvas pouch keeps all tools close at hand

Item	Description	Qty	\$
6-1030-50	Basic Training Kit Includes SunStim Nerve Stimulator	1	\$229.95
6-1030-52	Student Training Kit Includes SunStim Plus Nerve Stimulator	1	\$239.95
6-1030-53	Professional Training Kit Includes SunStim Pro Nerve Stimulator	1	\$269.95



Precordial Accessories Diagnostic Basics

• LATEX FREE • REUSABLE •

- Available as a kit or separate components
- Newborn/infant chest pieces are hollow, lightweight
- Child/adult chest pieces are solid with deep sound chamber
- Kit includes four chest pieces, monoscope, double adhesive disks
- Chest pieces feature a luer slip male connector to attach to monoscope
- Monoscope acoustic earpiece enhances transmission of sound by perfectly conforming to the ear canal

Item	Description	Size	Qty	\$
6-0025-05	Precordial Chest Piece Kit	-	1	\$29.95
6-0025-00	0.875" Hollow Chest Piece	Newborn	1	\$8.95
6-0025-01	1.125" Hollow Chest Piece	Infant	1	\$8.95
6-0025-02	1.125" Solid Chest Piece	Child/Adult	1	\$10.95
6-0025-03	1.440" Solid Chest Piece	Large Adult	1	\$10.95
6-1030-25	Comfort Fit Soft Ear Monoscope	--	25	\$59.95
6-0025-25	Double Adhesive Discs	--	100/roll	\$12.95



Complete Precordial Kit Shown Here
6-0025-05



Handheld Pulse Oximeter Full Featured Pulse Oximeter

• LATEX FREE • REUSABLE •

- Durable yet lightweight design
- Ergonomically designed to fit your hand comfortably
- Quantitative pulse strength bar on screen
- Simple ON/OFF control with auto shut-off to conserve battery life
- Monitor patients ranging from neonate to adult
- Genuine BCI reusable and disposable sensors available
- 1,000 spot checks, up to 99 patients

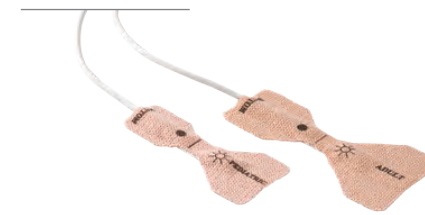

8-1301-00 / 8-1300-00



8-3339-00

Item	Description	Qty	\$
8-3301-00	BCI 3301 Handheld Pulse Oximeter	1	\$478.95
8-3315-00	Carry Case w/Belt Clip & Shoulder Strap	1	\$53.95
8-3339-00	P.C. Cable	1	\$33.95
8-3311-00	Oximeter Cable Replacement	1	\$53.95
8-3044-00	Oximeter Finger Sensor	1	\$169.95
8-3444-00	Oximeter Comfort-Clip Finger Sensor	1	\$169.95
8-1300-00	Adult Disposable Finger Sensor	10	\$130.95
8-1301-00	Pediatric Disposable Finger Sensor	10	\$130.95
8-1302-00	Neonate Disposable Finger Sensor	10	\$130.95
8-1303-00	Infant Disposable Finger Sensor	10	\$130.95

Specifications	Handheld Pulse Oximeter
SpO ₂	LED numeric display 0.46" high
Pulse Rate	LED numeric display 0.38" high
Pulse Strength	Logarithmically scaled, 8-segment bar graph
Keys	ON and OFF keys, SpO ₂
Range	-99% SpO ₂
Accuracy	± 2% at 70-99%, <70% unspecified
Pulse Rate	8 beats
Range	30-254 bpm

Dual Head Stethoscope Economical Choice

• LATEX FREE • REUSABLE •

- Molded one piece Y tubing
- High sensitivity and lightweight
- Anodized aluminum chestpiece
- Chrome-plated brass binaurals
- 31" overall length

Item	Description	Qty	\$
6-0027-40	Dual Head Stethoscope, Black	1	\$7.95
6-0027-41	Dual Head Stethoscope, Red	1	\$7.95
6-0027-42	Dual Head Stethoscope, Gray	1	\$7.95
6-0027-43	Dual Head Stethoscope, Hunter Green	1	\$7.95

- Black
- Red
- Gray
- Hunter Green



MainlineMedical.com
more great products online

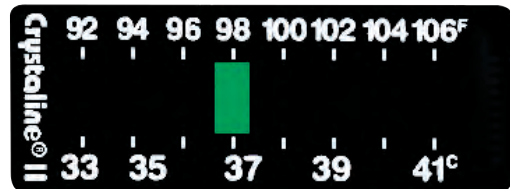

less than
90¢
each

Crystalline™ II Temp Trend Indicator

Best Selling Temperature Strip

• LATEX FREE • DISPOSABLE •

- Accurate core adjusted 92° - 106°F (33° - 41°C)
- Handy wall mount dispenser box
- Economical

Item	Description	Qty	\$
8-5101-01	Crystalline II Temp Trend Indicator	100	\$87.95
8-5101-02	Crystalline II Temp Trend Indicator	50	\$43.95

Perfusion Skin Temp Monitors

Suitable for EMGs, RSD Diagnosis

• LATEX FREE • DISPOSABLE •

- Temperature indicators read and display skin temperature
- Useful for assessing the effectiveness of nerve blocks by watching for a sympathetic rise in temperature
- Quantify your block
- Preferred by pain-management specialists

Item	Description	Qty	\$
8-6102-00	Crystalline ST Temp Monitor	100	\$132.95
8-6102-05	DermaTherm Temp Monitor	100 (roll)	\$79.95

TempAlert™ II Temp Trend Indicator

Comparative Readings

• LATEX FREE • DISPOSABLE •

- Cut your costs without sacrificing reliability
- From pre-op to recovery and beyond, TempAlert II stays with the patient
- No interruptions in monitoring
- Comparative readings reflect changes in the patients, not in the device
- Core adjusted 94° - 106°F (34.4° - 41°C)
- Handy wall mount dispenser box

Item	Description	Qty	\$
8-8501-63	TempAlert II Indicator	100	\$75.95
8-8501-64	TempAlert II Indicator	50	\$40.95

NOVAMEDUSA



less than
90¢
each

AccuTherm™ Forehead Temp Indicator

Responds in Seconds!

• LATEX FREE • DISPOSABLE •

- Accurate within ±5°F (0.3°C) of esophageal probes
- Liquid crystal, MRI safe
- Uses safety-tested hypoallergenic adhesive
- Convenient dispenser box

Item	Description	Qty	\$
8-1008-10	AccuTherm Temperature Indicator	100	\$87.95

PHILIPS
RESPIRONICS

less than
\$1.40
each



Liquid Crystal Accu-Bar

Core Adjusted Readings

• LATEX FREE • DISPOSABLE •

- Accurate 1°F temperature readings and obtain 1/2° color interpretation
- Simple, non-invasive and economical temperature monitoring
- Core adjusted 94° - 105°F (34.4° - 40.5°C)
- Clearly marked degrees
- Liquid crystal measures skin temp with core-adjusted reading in seconds

Item	Description	Qty	\$
8-1050-00	Liquid Crystal ACCU-BAR Temp Indicator	100	\$138.95

Temperature Strips

Economical & Reliable

• LATEX FREE • DISPOSABLE •

- Non-invasive
- Horizontal strips core adjusted 94° - 104°F (34.4° - 40°C)
- Vertical strips core adjusted 94° - 106°F (34.4° - 41.1°C)
- Easy to read bright colors

Item	Description	Qty	\$
8-1886-40	Single Degree Increments Temp Strip, Horizontal	100	\$57.95
8-1886-50	Two Degree Increments Temp Strip, Horizontal	100	\$37.95
8-1886-60	Two Degree Increments Temp Strip, Vertical	100	\$35.95

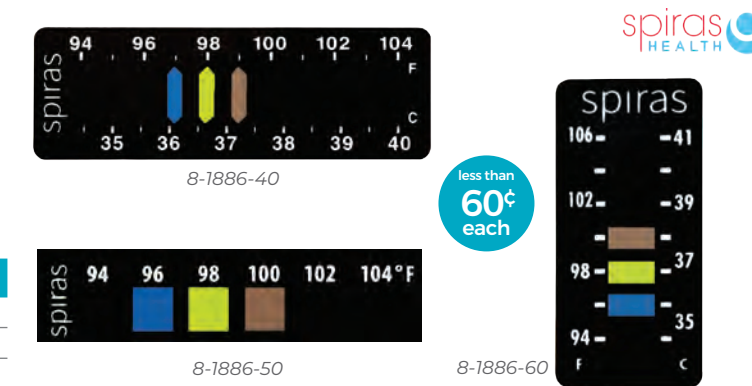

spiras
HEALTH

less than
60¢
each

Liquid Crystal Temperature Indicators

MR Conditional

• LATEX FREE • DISPOSABLE •

- Reads both Centigrade and Fahrenheit
- Easy to read
- Temp-Assure core adjusted 90° - 106°F (32.2° - 41.1°C)
- Mini core adjusted 96° - 104°F (35.5° - 40°C)
- Mini designed to fit easily on children and adults



Item	Description	Qty	\$
8-0105-05	Temp-Assure Liquid Crystal Temp Indicator	100	\$72.95
8-0104-04	Mini Liquid Crystal Temp Indicator	100	\$37.95

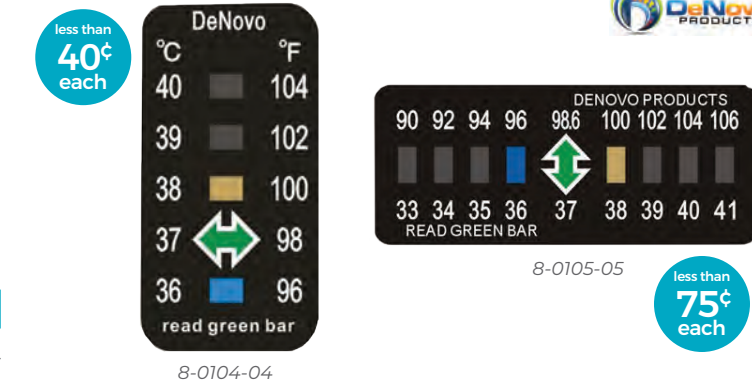

DeNovo
PRODUCTS

less than
40¢
each

less than
75¢
each

Trademark
Medical

less than
\$1.64
each

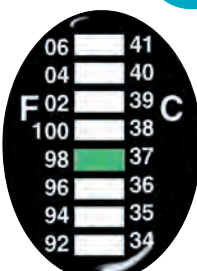

Kwik-Skan™ Temp Trend Indicator

Easy to Read Vertical Scale

• LATEX FREE • DISPOSABLE •

- Oval design permits better contact with blood flow patterns for more accurate readings
- Non-allergenic backing
- MRI safe
- Wider range of reading 92° - 106°F (33° - 41°C)
- Can be worn for extended lengths of time

Item	Description	Qty	\$
8-5030-10	Kwik-Skan Indicator	100	\$163.95

LGRHallcrest

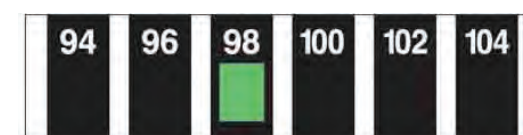

less than
\$1.35
each

FeverScan® Temperature Indicator

Hypoallergenic Adhesive is Repositionable

• LATEX FREE • DISPOSABLE •

- Color turns tan to green to blue as the temperature increases
- Temperature range: 94° - 105°F (34.4° - 41.1°C)

Item	Description	Qty	\$
8-9449-20	FeverScan Temp Indicator	100	\$130.95

Stat Skan® LCD Temperature Indicator

Reduces Risk of Undetected Malignant Hyperthermia

• LATEX FREE • DISPOSABLE •

- Easy-to-read numbers
- Temperature range: 95° - 107°F (36° - 42°C)
- MRI safe

less than
\$2.20
each

Item	Description	Qty	\$
8-6510-01	Stat Skan Temp Indicator	100	\$216.95

NOVAMEDUSA

**LIFESOUND®
Esophageal
400 Series
Stethoscopes**

Unparalleled Sound Quality
with Temperature Monitoring

• LATEX FREE • DISPOSABLE •

- Accuracy in monitoring core body temperature
- Exceptional breath sound reproduction
- Engineered to maximize transmission of heart and breath sounds
- Reliable temperature accuracy ±0.2° C for full clinical scale



Item	Description	Size	Qty	\$
6-1535-09	LIFESOUND Esophageal Stethoscope	9 Fr	40	\$180.95
6-1540-12	LIFESOUND Esophageal Stethoscope	12 Fr	40	\$180.95
6-1550-18	LIFESOUND Esophageal Stethoscope	18 Fr	40	\$180.95
6-1560-24	LIFESOUND Esophageal Stethoscope	24 Fr	40	\$180.95

NOVAMEDUSA

**NOVATEMP®
400 Series Tympanic
Temperature Sensor**

Provides a Reliable, Accurate, Non-Invasive Option
to Measure Core Body Temperatures

• LATEX FREE • STERILE • DISPOSABLE •

- Unique design facilitates ease of tympanic placement
- Reliable temperature accuracy ±0.2° C for full clinical scale
- Long lead wire in twisted pair configuration for safer procedures
- Stress-free custom-fitted molded connector with double strain relief for operating room reliability



Item	Description	Qty	\$
6-5261-60	NOVATEMP Tympanic Temp Sensor	60	\$353.95

NOVAMEDUSA

**NOVATEMP®
General Purpose
400 Series
Temperature Probes**

Versatile Temp Monitoring Ensuring Ideal Accuracy

• LATEX FREE • DISPOSABLE •

- Recommended for esophageal, nasopharyngeal, axillary or rectal use
- Reliable temperature accuracy ±0.2° C for full clinical scale
- Satin finish tubing ensures flexibility, ease of use and patient comfort
- Twisted pair wiring and double strain relief provides safety reinforcement

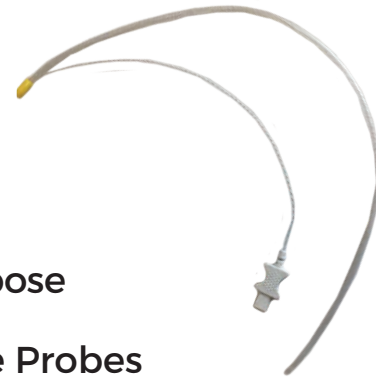

Item	Description	Size	Qty	\$
6-1610-09	Temperature Probe for Esophageal, Nasopharyngeal or Rectal Use	9 Fr	40	\$180.95
6-1620-12	Temperature Probe for Esophageal, Axillary or Rectal Use	12 Fr	40	\$180.95

NOVAMEDUSA

**NOVATEMP® 400 Series
Skin Temperature Sensor**

Unique Thermistor Design Ensures Rapid Response to Reflect
Temperature Change for Full Scale Clinical Accuracy

• LATEX FREE • DISPOSABLE •

- Reliable temperature accuracy ±0.2° C for full clinical scale
- Extended 32" length lead wire
- "Perfect fit" molded connector ensures a trouble free connection and continuous temperature monitoring
- Utilizes non-invasive 1" adhesive foam disk
- Hypoallergenic for sensitive skin



Item	Description	Qty	\$
6-1600-30	NOVATEMP Skin Temp Sensor	30	\$146.95
6-1600-40	NOVATEMP Skin Temp Sensor	90	\$313.95

NOVAMEDUSA

**NOVATEMP® Temperature
Adapter Cables**

Exclusively for Philips Monitors; Compatible with
400 Series Temperature Probes

• REUSABLE •

- Single piece construction provides direct connection between monitor and temperature probe
- Flexible stress relief at both ends
- Gold plated two pin din connector for improved reliability

Item	Description	Length	Qty	\$
6-4010-01	Adapter Cable for 400 Series Temp Probes	12'	1	\$66.95
6-4010-02	Adapter Cable for 400 Series Temp Probes	20'	1	\$80.95



**NOVATEMP® Temperature
Adapter Cables**

Exclusively for Philips Monitors & Philips/Bard Probes

• REUSABLE •

- Connects Philips monitors to 1/8" phono plug in Philips temperature probes and Bard temperature sensing foley catheters
- Molded single piece construction ensures durability and reliability
- Flexible stress relief at both ends
- Unique gold-plated two pin din connector mates to Philips perfectly

Item	Description	Length	Qty	\$
6-4040-01	Adapter Cable for Philips/Bard Temp Probes	12'	1	\$133.95

NOVAMEDUSA

**NOVATEMP® Temperature
Adapter Cables with ¼" Phono Plugs**

Compatible with All 400 Series Temperature Probes

• REUSABLE •

- Single piece construction provides direct connection between monitor and temperature probe
- Flexible stress relief at both ends
- Two lengths: 12' and 20'
- Straight or right angle ¼" plugs

Item	Description	Length	Qty	\$
6-4000-00	1/4" Right Angle Phono Plug	12'	1	\$60.95
6-4000-02	1/4" Right Angle Phono Plug	20'	1	\$80.95
6-4020-20	1/4" Straight Phono Plug	20'	1	\$80.95

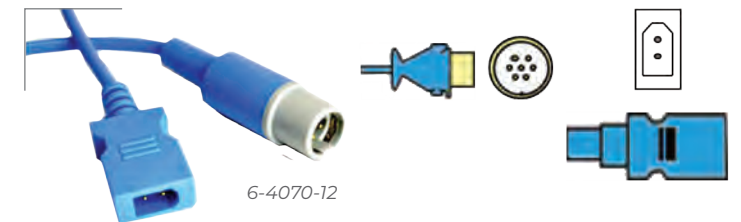

**NOVATEMP® Temperature
Adapter Cables**

Exclusively for Dräger Infinity Series Monitors

• REUSABLE •

- Plugs directly into Dräger Infinity and Siemens SC Series monitors
- Fits all 400 Series temperature probes
- Available in two convenient lengths

Item	Description	Length	Qty	\$
6-4070-12	Temperature Adapter Cable	12'	1	\$100.95
6-4070-04	Temperature Adapter Cable	4'	1	\$100.95

Truer Medical, Inc.



400 Series Skin Sensor

Accurately Assess Skin Temperature

• LATEX FREE • DISPOSABLE •

- Reflective metal cover insulates sensor to prevent OR lights or heat lamps from affecting actual temperature
- Foam pad seals area between skin and sensor to eliminate ambient air that can affect temperature reading
- Hypoallergenic adhesive foam allows for easy placement and removal

Item	Description	Qty	\$
6-0400-00	400 Series Skin Temp Sensor	200	\$462.95

Truer Medical, Inc.

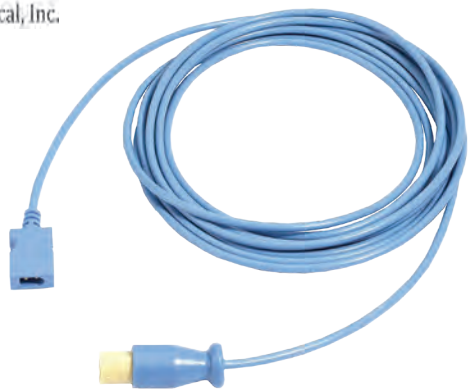

400 Series Monitor Interface Cable

Works with Leading Monitors

• REUSABLE •

- Compatible with standard probes
- Connects to leading monitors: HP-type and phonojack options
- 15' Length for ease of use
- Reusable

Item	Description	Qty	\$
6-7032-00	400 Series Interface Cable with HP-Type Connector	1	\$31.95
6-7032-10	400 Series Interface Cable with Phonojack Connector	1	\$31.95

Truer Medical, Inc.

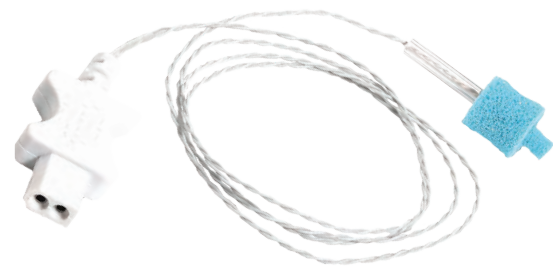

400 Series Tympanic Probe Sensor

Monitor Core Body Temperature

• LATEX FREE • DISPOSABLE •

- Less invasive alternative to esophageal or rectal probes for monitoring core body temperature
- Soft, memory-cell foam conforms to ear canal
- Seals out ambient air which can affect temperature reading

Item	Description	Qty	\$
6-0410-00	400 Series Tympanic Probe Sensor	50	\$168.95

Truer Medical, Inc.

400 Series Esophageal Sensor

Monitor Heart, Breath & Temperature Simultaneously

• LATEX FREE • DISPOSABLE •

- Monitors vital signs of anesthetized patients
- Soft, thin-walled cuff provides maximum sound transmission
- Male luer allows convenient attachment to standard acoustical earpieces
- Standard cuff and high cuff



High Cuff

Item	Description	OD	Qty	\$
6-2400-12	400 Series Esophageal Sensor	12 Fr	50	\$101.95
6-8400-18	400 Series Esophageal Sensor	18 Fr	50	\$101.95
6-4400-24	400 Series Esophageal Sensor	24 Fr	50	\$101.95

Standard Cuff

Item	Description	OD	Qty	\$
6-9400-09	400 Series Esophageal Sensor	9 Fr	50	\$101.95
6-1240-12	400 Series Esophageal Sensor	12 Fr	50	\$101.95
6-1840-18	400 Series Esophageal Sensor	18 Fr	50	\$101.95
6-2440-24	400 Series Esophageal Sensor	24 Fr	50	\$101.95

WelchAllyn

SureTemp® Plus 690 Thermometers

The Speed You Want with the Accuracy You Need

• REUSABLE •

- 4 second oral temps / 15 second axillary temps / 10 second rectal temps
- Automatic probe cover ejector
- Storage for 25 probe covers
- Large LCD Display – Fahrenheit or Celsius
- Waterproof, stainless steel probe shaft
- Mode button with last temperature recall
- Ergonomic design for comfort
- Optional rolling stand for security and portability
- Rubberized grip for ease of handling



8-1679-40



8-1679-20



8-8072-00

SureTemp Plus 690 Thermometers

Item	Description	Qty	\$
8-1679-20	SureTemp Plus 690 Only	1	\$319.95
8-1679-40	SureTemp Plus 690 with Wall Mount	1	\$335.95
8-1679-70	SureTemp Plus 690 with Rolling Stand	1	\$702.95

Accessories

Item	Description	Qty	\$
8-2679-00	4" Rectal Probe	1	\$97.95
8-2679-10	9" Rectal Probe	1	\$113.95
8-5031-10	Disposable Probe Covers*	1250	\$66.95
8-5031-75	Disposable Probe Covers*	7500	\$330.95
8-8043-20	SureTemp Probe Holder**	1	\$24.95
8-8072-00	SureTemp Rolling Stand w/ Basket	1	\$390.95

*Probe covers are non-returnable **Probes not included



CareTemp™ Touch-Free Thermometer

Accurately Screen Patient Temperatures Without Contact

• REUSABLE •

- Infrared sensor reads temperatures 4-6cm from the center of the head
- Feature to help workflow; pulse timer, temperature memory recall
- Touch-free sensor head to help minimize cross contamination
- Takes 3,000 readings per battery set (2-"AAA" batteries included)
- Easy-to-read large, backlit LCD display
- 2 year warranty

Item	Description	Qty	\$
8-1058-01	CareTemp Touch-Free Thermometer	1	\$237.95

Large backlit LCD Display

Memory Recall to display last measurement taken

Ergonomic handle

Proprietary distance sensor assists with consistent measurement

Easily switch between Fahrenheit and Celsius

60 second timer for manual pulse and respiration measurement

WelchAllyn



Tycos® 767 Wall & Mobile Aneroid
Top of the Line for Accuracy, Reliability, Durability

• LATEX FREE • REUSABLE •

- Certified accuracy to +/- 3 mm Hg
- Mercury free
- Ruby jeweled movement for long life
- Large (6.25"), easy-to-read laser engraved dial face
- Built in cuff storage basket
- Mobile stand has adjustable height and 360° swivel
- Aneroid swivels left and right
- Lifetime calibration warranty

Aneroids

Item	Description	Qty	\$
2-7670-21	767 Wall Aneroid with Adult Cuff	1	\$231.95
2-7670-22	767 Mobile Aneroid with Adult Cuff	1	\$409.95

Inflation Systems

Item	Description	Qty	\$
2-5082-70	Two Tube Inflation System, Adult	1	\$74.95
2-5082-71	Two Tube Inflation System, Large Adult	1	\$74.95
2-5082-72	Two Tube Inflation System, Child	1	\$71.95



Tycos® Blood Pressure Inflation Systems
Cuffs and Inflation Bulbs Sold Separately

• LATEX FREE • REUSABLE •

- Comes with durable hook-and-loop closure
- Can be used with aneroid and mercury sphygmomanometers
- Easy to clean
- Ready-to-use cuffs and bladders include heavyweight durable nylon cuffs and latex free bladders
- Available with one and two tube bladders
- 2 year warranty

One Tube Configuration

Item	Description	Size	Qty	\$
2-5082-03	Cuff & One Tube Bladder	Infant	1	\$62.95
2-5082-07	Cuff & One Tube Bladder	Newborn	1	\$63.95
2-5082-42	Cuff & One Tube Bladder	Child	1	\$70.95
2-5082-43	Cuff & One Tube Bladder	Adult	1	\$48.95
2-5082-44	Cuff & One Tube Bladder	Large Adult	1	\$48.95

Two Tube Configuration

Item	Description	Size	Qty	\$
2-5082-08	Cuff & Two Tube Bladder	Infant	1	\$60.95
2-5082-24	Cuff & Two Tube Bladder	Child	1	\$70.95
2-5082-25	Cuff & Two Tube Bladder	Adult	1	\$48.95
2-5082-26	Cuff & Two Tube Bladder	Large Adult	1	\$48.95

Inflation Bulbs

Item	Description	Qty	\$
2-5088-01	Bulb with Valve	1	\$21.95
2-5086-01	Standard Latex bulb	1	\$21.95

Precision Aneroid Sphygmomanometer
Economically Priced, High Quality Blood Pressure Kit

• LATEX FREE • REUSABLE •

- Navy blue calibrated nylon cuff
- Standard air release valve
- EZ View luminiscent dial
- Comes in convenient carry case
- 5 year neoprene inflation system warranty
- 10 year calibration warranty

Item	Description	Size	Qty	\$
2-9141-11	Precision Blood Pressure Kit	Adult	1	\$44.95
2-9141-15	Precision Blood Pressure Kit	Child	1	\$33.95
2-9141-16	Precision Blood Pressure Kit	Large	1	\$36.95

MainlineMedical.com
more great products online



smths medical



SODASORB® CO₂ Absorbent
World's Leading Brand of CO₂ Absorbent

- Color changes when absorbent capacity is exhausted
- Low dusting - conforms to strict hardness standard
- Three packaging options available

Item	Description	Qty	\$
7-0088-60	Sodasorb 2.5 lb Canister Pak (Refill Bag)	12	\$92.95
7-0088-70	Sodasorb 3 lb Pre-Pak (Canister Discs)	12	\$138.95
7-0088-80	Sodasorb 5 Gallon Pail	1	\$89.95



LoFloSorb CO₂ Absorbent
Contains No Alkali Hydroxide

- Minimizes the risk associated with reactions with volatile anesthetics
- LoFloSorb contains no Potassium Hydroxide and no Sodium Hydroxide
- Made of 3-4 mm spheres processed to minimize potential dusting
- Features a very stable green to violet color change
- Long history of use within anesthesia

Item	Description	Qty	\$
7-2178-02	LoFloSorb, 5 L Jerican	2	\$76.95
7-2188-02	LoFloSorb, 1 kg Drum	10	\$172.95
7-2193-02	LoFloSorb, 1 kg Pyramid	6	\$126.95

Calibrated V-Lok® Inflation Systems with Single Stem

Luer Lock, Rectus Connectors Available

• REUSABLE • LATEX • LATEX FREE •

- Bladder center is clearly marked on the inner and outer surface of the cuff for correct application on either right or left limb
- Cuffs are made of non-absorbent, stain resistant fabric
- Black latex tubing; terracotta latex-free tubing
- Made to fit dimensions of corresponding name-size

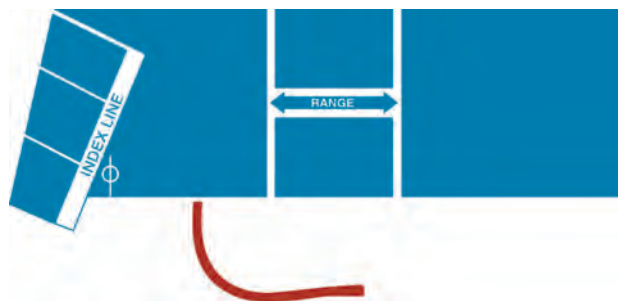
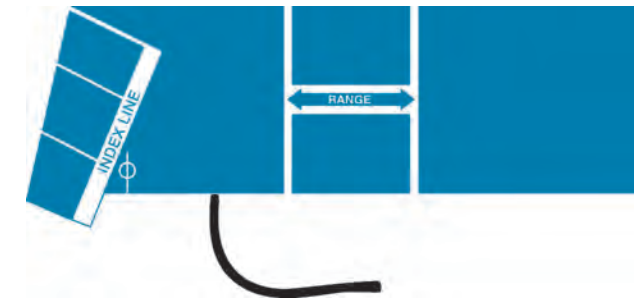

V-Lok, Single Stem with Luer Lock*

Item	Description	Latex	Qty	\$
2-0660-90	V-Lok Inflation System, Adult	Yes	1	\$21.95
2-0660-91	V-Lok Inflation System, Child	Yes	1	\$19.95
2-0660-92	V-Lok Inflation System, Infant	Yes	1	\$17.95
2-0660-94	V-Lok Inflation System, Large Arm	Yes	1	\$28.95
2-0660-95	V-Lok Inflation System, Thigh	Yes	1	\$36.95
2-1880-90	V-Lok Inflation System, Adult	No	1	\$22.95
2-1881-91	V-Lok Inflation System, Child	No	1	\$19.95
2-1882-92	V-Lok Inflation System, Infant	No	1	\$18.95
2-1869-94	V-Lok Inflation System, Large Arm	No	1	\$28.95
2-1884-94	V-Lok Inflation System, Thigh	No	1	\$36.95

*Compatible with Accuto, B. Braun, Datascope, Colin, Frager, Mennen



V-Lok, Single Stem*

Item	Description	Latex	Qty	\$
2-0661-85	V-Lok Inflation System, Adult	Yes	1	\$18.95
2-0661-86	V-Lok Inflation System, Child/Small Adult	Yes	1	\$16.95
2-0661-87	V-Lok Inflation System, Infant	Yes	1	\$14.95
2-0661-88	V-Lok Inflation System, Newborn	Yes	1	\$12.95
2-0661-89	V-Lok Inflation System, Large Arm	Yes	1	\$25.95
2-0661-90	V-Lok Inflation System, Thigh	Yes	1	\$33.95
2-1880-19	V-Lok Inflation System, Adult	No	1	\$20.95
2-1881-20	V-Lok Inflation System, Child/Small Adult	No	1	\$18.95
2-1882-21	V-Lok Inflation System, Infant	No	1	\$16.95
2-1883-22	V-Lok Inflation System, Newborn	No	1	\$15.95
2-1884-23	V-Lok Inflation System, Thigh	No	1	\$35.95
2-1869-24	V-Lok Inflation System, Large Arm	No	1	\$27.95

*Compatible with North American Drager, Datascope, Colin, Mennen

V-Lok, Single Stem with Male Rectus Connector*

Item	Description	Latex	Qty	\$
2-0660-80	V-Lok Inflation System, Adult	Yes	1	\$18.95
2-0660-81	V-Lok Inflation System, Child/Small Adult	Yes	1	\$16.95
2-0660-82	V-Lok Inflation System, Infant	Yes	1	\$14.95
2-0660-84	V-Lok Inflation System, Thigh	Yes	1	\$32.95
2-0660-69	V-Lok Inflation System, Large Arm	Yes	1	\$25.95
2-1818-00	V-Lok Inflation System, Adult	No	1	\$22.95
2-1818-81	V-Lok Inflation System, Child/Small Adult	No	1	\$19.95
2-1818-82	V-Lok Inflation System, Infant	No	1	\$18.95
2-1818-84	V-Lok Inflation System, Thigh	No	1	\$37.95
2-1818-69	V-Lok Inflation System, Large Arm	No	1	\$28.95

*Compatible with Phillips, Agilent Nelcor, Hewlett Packard, Siemens, Space Labs

Bariatric Inflation Systems

Latex & Latex-Free Versions

• REUSABLE • LATEX • LATEX FREE •

- Includes: Cuff, inflation bag, large bulb and Air-Flo control valve
- Range of limb circumference: 46-66 cm
- Curved, easy to apply and conforms naturally to a conical limb
- Allows correct application of the cuff and even compression of the artery
- Black latex tubing; terracotta latex-free tubing

Item	Description	Latex	Qty	\$
2-1830-01	Bariatric Inflation System	Yes	1	\$56.95
2-1830-03	Bariatric Inflation System	No	1	\$60.95

Calibrated V-Lok® Inflation Systems with Double Stem

Latex & Latex-Free Versions

• REUSABLE • LATEX • LATEX FREE •

- Bladder center is clearly marked on the inner and outer surface of the cuff for correct application on either right or left limb
- Cuffs are made of non-absorbent, stain resistant fabric
- Black latex stem; terracotta latex-free tubing
- Made to fit dimensions of corresponding name-size

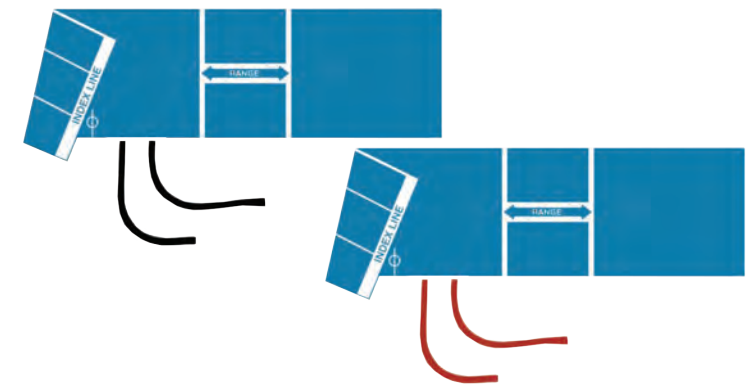

V-Lok, Double Stem

Item	Description	Latex	Qty	\$
2-0661-80	V-Lok Inflation System, Adult	Yes	1	\$18.45
2-0661-81	V-Lok Inflation System, Child/Small Adult	Yes	1	\$16.30
2-0661-82	V-Lok Inflation System, Infant	Yes	1	\$14.60
2-0661-83	V-Lok Inflation System, Newborn	Yes	1	\$12.65
2-0661-69	V-Lok Inflation System, Thigh	Yes	1	\$33.95
2-0661-84	V-Lok Inflation System, Large Arm	Yes	1	\$25.50
2-1880-13	V-Lok Inflation System, Adult	No	1	\$20.95
2-1881-14	V-Lok Inflation System, Child/Small Adult	No	1	\$18.95
2-1882-15	V-Lok Inflation System, Infant	No	1	\$16.95
2-1883-16	V-Lok Inflation System, Newborn	No	1	\$15.95
2-1884-17	V-Lok Inflation System, Thigh	No	1	\$35.95
2-1869-18	V-Lok Inflation System, Large Arm	No	1	\$27.95

V-Lok, Double Stem with Threaded Adapter*

Item	Description	Latex	Qty	\$
2-0660-96	V-Lok Inflation System, Adult	Yes	1	\$19.95
2-0660-97	V-Lok Inflation System, Child	Yes	1	\$17.95
2-0660-98	V-Lok Inflation System, Infant	Yes	1	\$15.95
2-0660-00	V-Lok Inflation System, Large Arm	Yes	1	\$26.95
2-0660-01	V-Lok Inflation System, Thigh	Yes	1	\$35.95
2-1880-96	V-Lok Inflation System, Adult	No	1	\$20.95
2-1881-97	V-Lok Inflation System, Child	No	1	\$18.95
2-1882-98	V-Lok Inflation System, Infant	No	1	\$16.95
2-1869-00	V-Lok Inflation System, Large Arm	No	1	\$26.95
2-1884-01	V-Lok Inflation System, Thigh	No	1	\$34.95

*Compatible with Dinamap, Critkon, Welch Allyn, Mennen, Kontron

Calibrated V-Lok® Cuff

Largest Selection of Sizes

• REUSABLE •

- Neoprene-coated Dacron cuff is non-absorbent and easy to clean
- Available with black latex or terracotta orange latex free tubing
- Color coded by size

Item	Description	Latex	Qty	\$
2-1820-24	V-Lok Cuff, Adult	Yes	1	\$28.95
2-1821-25	V-Lok Cuff, Child/Small Adult	Yes	1	\$24.95
2-1822-26	V-Lok Cuff, Infant	Yes	1	\$23.95
2-1823-27	V-Lok Cuff, Newborn	Yes	1	\$20.95
2-1824-28	V-Lok Cuff, Thigh	Yes	1	\$42.95
2-1825-29	V-Lok Cuff, Large Arm	Yes	1	\$36.95
2-1820-25	V-Lok Cuff, Adult	No	1	\$30.95
2-1821-26	V-Lok Cuff, Child/Small Adult	No	1	\$29.95
2-1822-27	V-Lok Cuff, Infant	No	1	\$27.95
2-1823-28	V-Lok Cuff, Newborn	No	1	\$24.95
2-1824-29	V-Lok Cuff, Thigh	No	1	\$48.95
2-1825-30	V-Lok Cuff, Large Arm	No	1	\$38.95

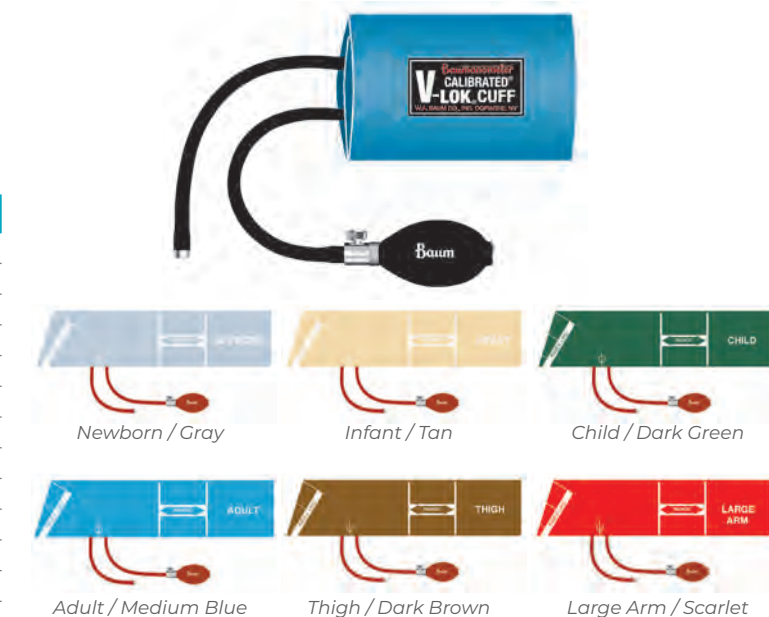

W.A. Baum Co. Inc.

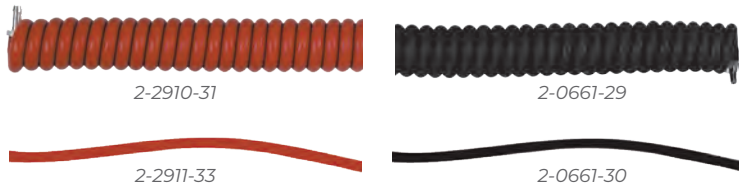

Replacement Extendex® & Straight Tubing

Available in Black Latex or Terracotta Orange Latex Free

• REUSABLE • LATEX • LATEX FREE •

- Provides a high quality alternative for patients and practitioners who are hypersensitive to natural rubber latex
- Ozone resistant
- Extended tubing is permanently coiled, retractile
- Straight tubing is sold per foot; must specify at time of order

Item	Description	Qty	\$
2-0661-29	8' Extendex Tube with Connectors, Latex	1	\$9.95
2-0661-30	Straight Tubing, Latex	-	\$1.95/ft
2-2910-31	8' Extendex Tube w/ Connectors, Latex Free	1	\$12.95
2-2911-33	Straight Tubing, Latex Free	-	\$1.95/ft

W.A. Baum Co. Inc.

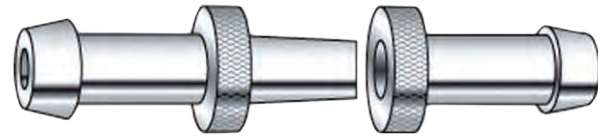

Tubing Connector Set

Male & Female Connections

• REUSABLE • LATEX •

- Female end is made of aluminum
- Male end is made of nickel chrome-plated brass
- Connectors can be cleaned with any disinfectant including rubbing alcohol

Item	Description	Qty	\$
2-0661-92	Tubing Connector Set	1	\$0.95

Baumanometer

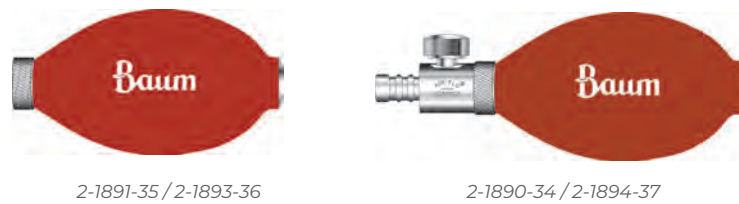
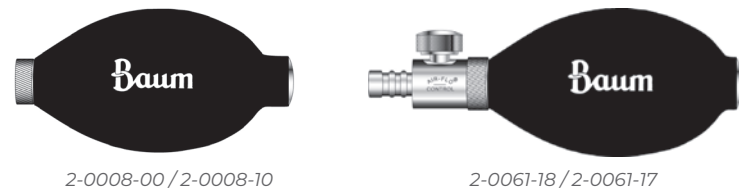

Replacement Inflation Bulb & Valve

Extend the Life of Your Pressure Cuff

• REUSABLE • LATEX • LATEX FREE •

- Pressure source for all sphygmomanometers
- Air control valve body and air release are precision machined brass, nickel and chrome
- Available in black latex or terracotta orange latex free

Latex (Black)

Item	Description	Qty	\$
2-0661-18	Standard Bulb & Airflow Control Valve, Latex	1	\$11.95
2-0661-17	Large Bulb & Airflow Control Valve, Latex	1	\$11.95
2-0008-00	Standard Bulb Only, Latex	1	\$6.95
2-0008-10	Large Bulb Only, Latex	1	\$4.95

Latex Free (Terracotta)

Item	Description	Qty	\$
2-1890-34	Standard Bulb & Airflow Control Valve, Latex Free	1	\$12.95
2-1894-37	Large Bulb & Airflow Control Valve, Latex Free	1	\$12.95
2-1891-35	Standard Bulb Only, Latex Free	1	\$4.95
2-1893-36	Large Bulb Only, Latex Free	1	\$5.95
2-0009-00	Air Control Valve Only, Latex Free	1	\$8.95

Sensoronics

Oxygen Sensor Replacements

Compatible with Leading Monitoring Technology

• LATEX FREE • DISPOSABLE •

- For most anesthesia and respiratory applications
- Unconditional 1 year warranty
- Individually wrapped

Item	Oxygen Sensor	Replaces	\$
8-4100-03	SS-03	Teledyne T7 & Fits Most Teledyne Analyzers	\$64.95
8-4100-11	SS-11A	Teledyne R17 & Catalyst (MSA) 406931	\$64.95
8-4100-20	SS-20A	Ohmeda 6050-0004-110	\$90.95
8-4100-25	SS-25A	Maxtec Max-25E/250E & Ceramtec CAG-25E/250E	\$64.95
8-4100-12	SS-12A	Teledyne R-22 & Catalyst (MSA) 472062	\$64.95
8-4100-14	SS-14A	Drager 68-50645	\$90.95
8-4100-10	SS-10A	Ohmeda 0237-2034-700	\$90.95
8-4100-52	SS-12CC	For Use with Criticare Monitors	\$59.95
8-4100-05	SS-05	Teledyne R13 & Hudson 5500	\$64.95
8-4100-26	SS-26	Catalyst (MSA) 806572	\$64.95
8-4100-51	SS-12AIR	For Use with Air Shields Incubators	\$59.95



8-4100-03



8-4100-11



8-4100-25



8-4100-12



8-4100-14

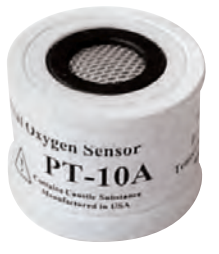

8-4100-10



8-4100-20



8-4100-52



8-4100-05



8-4100-26



8-4100-51

DIAGNOSTICS • SpO₂ Sensors

Sensoronics SpO₂ Sensors • REUSABLE •

Item	Description	Compatible OEM Brand	Compatible Model #	Connector	Sensor Style	Qty	\$
8-4000-01	3' Finger Clip, Adult	BCI	BCI: 3401, 3304, 3303, 3302, 3301, 3300			1	\$73.95
8-4000-20	3' Finger Clip, Pediatric					1	\$73.95
8-4000-21	3' Silicone Sensor, Adult		Spacelabs Burdick: PRO2			1	\$80.95
8-4000-22	3' Silicone Sensor, Pediatric		Dräger: Oxipac 2000			1	\$80.95
8-4000-90	3' Finger Clip, Adult	Masimo	All LNCS style sensors			1	\$73.95
8-4000-91	3' Silicone Sensor, Adult					1	\$80.95
8-4000-30	3' Finger Clip, Pediatric	Nelcor	Nelcor			1	\$73.95
8-4000-31	9' Finger Clip, Adult					1	\$73.95
8-4000-32	9' Finger Clip, Adult					1	\$73.95
8-4000-33	3' Silicone Sensor, Adult					1	\$80.95
8-4000-34	3' Silicone Sensor, Pediatric					1	\$80.95
8-4000-35	9' Silicone Sensor, Adult					1	\$80.95
8-4000-36	9' Silicone Sensor, Pediatric					1	\$80.95
8-4000-40	3' Finger Clip, Adult			Nelcor (Oximax)	All Nelcor Applications		
8-4000-41	9' Finger Clip, Adult	1	\$73.95				
8-4000-42	3' Finger Clip, Adult					1	\$80.95
8-4000-43	9' Silicone Sensor, Adult					1	\$80.95

Sensoronics SpO₂ Sensors • DISPOSABLE •

Item	Description	Compatible OEM Brand	Compatible Model #	Connector	Qty	\$
8-4000-04	Foam Sensor, Adult	BCI	BCI: 3401, 3304, 3303, 3302, 3301, 3300		24	\$193.95
8-4000-05	Foam Sensor, Pediatric				24	\$193.95
8-4000-06	Foam Sensor, Infant	Spacelabs Burdick: PRO2			24	\$193.95
8-4000-14	Foam Sensor, Neonatal				24	\$193.95
8-4000-23	Foam Sensor, Adult	Masimo	Mindray, Dräger, GE, Philips, Physio Control, Datascope, Schiller, Spacelabs, Cas Medical, Zoll		20	\$160.95
8-4000-24	Foam Sensor, Pediatric				20	\$160.95
8-4000-25	Foam Sensor, Infant				20	\$160.95
8-4000-26	Foam Sensor, Neonatal				20	\$160.95
8-4000-10	Foam Sensor, Adult	Nelcor	Nelcor		24	\$193.95
8-4000-11	Foam Sensor, Pediatric				24	\$193.95
8-4000-12	Foam Sensor, Infant				24	\$193.95
8-4000-13	Foam Sensor, Neonatal				24	\$193.95

SpO₂ Cables • DIAGNOSTICS

SpO₂ Cables • REUSABLE •

Item	Description	Compatible Brand	Compatible Model #	Replaces	Oximeter Connector	Sensor Connector	\$
8-4400-08	8' Interface Cable w/ Rectangle 11p to DB9F Plug; Suitable for Nellcor Oximax Sensor	GE Medical (Oxi-tech module)	Dash 3000/4000/5000 with Nellcor OxiMax option Solar 8000/8000M, i9500 with Tram module 451N5/851N5	GE P/N 2021406-001			\$78.95
8-4400-11	10' Interface cable w/ Masimo Amp Connector to LNCS	Masimo	Masimo al. MDE:EscortII OPT30;Prism, GE Marquette;Pro1000,V300, INVIVO:T8, Schiller, ZOLL, Datascope Trio, Passport2, Spectrum (Must be MASIMO Module)	Masimo LNC 10			\$60.95
8-4400-12	10' Interface Cable w/ hemicycle 8p to DB9F Plug	Philips	Philips Medical: M2601A, M3000A, M350 0B, M4735A	Masimo P/N LNC MP10			\$60.95
8-4400-13	8' Interface Cable w/ hemicycle 8P to hemicycle 8J Plug	Philips	Philips Medical: M2601A, M3000A, M350 0B, M4735A	Philips P/N M1941A			\$49.95
8-4400-14	8' Interface Cable w/ Round 12P to hemicycle 8J Plug	Philips	Philips Medical: M2475B, M1732A/B, M1722A/B, M1020A, 78833C, 78833A, 78834A, 78352C, 78352A	Philips P/N M1940A			\$49.95
8-4400-18	4' Interface Cable w/ DB9M to DB9F Plug	Nelcor (Oxi-tech)	ALL Nelcor & Nelcor-equipped OEM monitors and patient cables with DB-9 Connector with Oximax Technology.	Nelcor P/N DEC-4			\$52.95
8-4400-19	8' Interface Cable w/ DB9M to DB9F Plug	Nelcor (Oxi-tech)		Nelcor P/N DEC-8			\$52.95
8-4400-20	8' Interface Cable w/ AMP14P to DB9F Plug	Nelcor (Oxi-tech)	Nelcor: N550, N-595 GE: Dinamap PRO (w/Oxi), Schiller	Nelcor P/N DOC-10			\$65.95



Tooth Protector
Minimize Dental Injuries

• LATEX FREE • DISPOSABLE •

- Helps prevent broken or chipped teeth during intubation, bronchoscopy, laryngoscopy, tonsillectomy and tooth extraction
- Helps reduce tooth injury
- Minimum bulk to allow maximum laryngoscope working space

Item	Description	Size	Qty	\$
9-3041-03	Tooth Protector	Adult	50	\$72.95

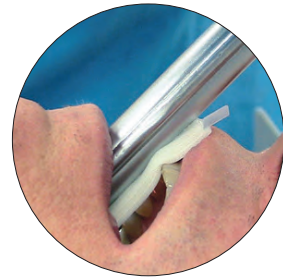

9-0010-10

DentaSafe™ Dental Guard Strips

Protect Upper Incisors

• LATEX FREE • DISPOSABLE •

- Help protect your patients from dental injuries during intubation
- Hypoallergenic
- Designed to stretch and conform
- Prevents costly damage to the upper incisors
- Available as a single strip roll of 50, twin pack or flat pack

Item	Description	Qty	\$
9-0010-10	Single Strip - Roll of 50	1	\$73.95
9-0012-10	Twin Pack - 2 Strip per Pack	25	\$85.95
9-0013-10	Flat Pack - 10 Strips per Pack	10	\$155.95



Biteguard™
Rigid Bite Block

• LATEX FREE • DISPOSABLE •

- Rigid, yet compressible design prevents damage to LMAs, dental work and fingertips
- Convenient handle provides quick, simple insertion

Item	Description	Qty	\$
9-3042-40	Bite Block	50	\$54.95



Endoguard™

Easy to Insert & Remove

• LATEX FREE • DISPOSABLE •

- Handle for easy removal; lifts tube to avoid lips
- Distributes force evenly across the teeth reducing the risk of damage
- Has raised serrated edges for superior cushioning
- Fits most adult mouths
- Individually wrapped

Item	Description	Qty	\$
9-2952-00	Tooth Protector	50	\$109.95



Bite Block

Accommodates ET Tubes

• LATEX FREE • DISPOSABLE •

- Assists with naso-gastric tube placement
- Accommodates up to 40 Fr tube
- Individually wrapped

Item	Description	Qty	\$
2060	Bite Block	20	\$44.95



IGuard™ Eye Protector
Non-Allergenic Adhesive

• LATEX FREE • STERILE • DISPOSABLE •

- Provides comfortable, effective patient eye protection
- Available in adult and pediatric sizes
- Non-allergenic adhesive
- Individually packaged

Item	Description	Size	Qty	\$
9-0210-00	IGuard	Adult	25	\$132.95
9-0210-21	IGuard	Pediatric	25	\$134.95
9-0210-20	Double Foam IGuard	Adult	25	\$134.95

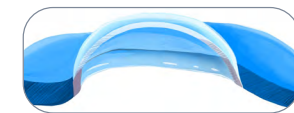

9-0210-00 - Standard Foam

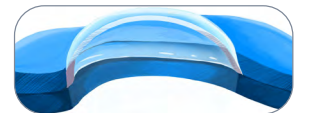

9-0210-20 - Double Foam

Opti-Gard® Eye Protectors
Flexible Foam Design

• LATEX FREE • STERILE • DISPOSABLE •

- Protect your patient's eyes during general anesthesia against corneal abrasion lacerations and scleral hemorrhage
- Protects eyes from drying out and foreign materials
- Made with rigid clear plastic covers
- Non-allergenic self-adhesive foam cushion

Item	Description	Size	Qty	\$
9-2820-00	Opti-Guard, Non Sterile	12yrs-Adult	25	\$135.95
9-2831-00	Opti-Guard, Non Sterile	Adult	25	\$135.95
9-2831-10	Opti-Guard, Sterile	Adult	25	\$135.95
9-2830-00	Double Foam Opti-Guard	Adult	25	\$149.95



9-2831-10

9-2830-00

Eye Protector Storage Dispenser

Ensures Stock Rotation, Visible for Easy Inventory Reorder

• LATEX FREE •

- Keyhole slots to mount into walls or carts
- Top hinged lid keeps dust off packaging
- Bottom slot designed for convenient access while keeping stock from falling out of the dispenser
- Use screws or magnets to mount
- 11.875" w x 18.25" h x 5.25" d

Item	Description	Qty	\$
9-0210-01	Storage Dispenser	1	\$48.95
9-0210-06	Magnet Mounts	2	\$37.95
9-0210-07	Magnet Mounts	4	\$70.95



9-0210-06



EyeGuard® Eye Protector

Gentle, Repositionable Covers

• LATEX FREE • DISPOSABLE •

- Reduce skin tears, irritated or bruised eye tissue
- Clear plastic covers protect eyes during surgery and other medical procedures
- Gentle on skin and eyelashes, easy to lift and reposition
- Tab design to avoid challenges with sticky tape and gloved hands
- Packaged in pairs
- Hypoallergenic
- Breathable, waterproof seal
- One size fits all

Item	Description	Qty	\$
9-2020-50	EyeGuard Eye Protector	50	\$44.95



VisiWrap™ Face Protection

Ideal for Patients in Supine Positions

• LATEX FREE • DISPOSABLE •

- Ideal for robotic procedures with patients in sleep trendelenburg position
- Provides minimal pressure on facial nerves
- Tears easily for an airway emergency
- Gentle, lightweight polyurethane foam conforms to facial anatomy
- Fire retardant - will NOT ignite

Item	Description	Qty	\$
9-0400-01	VisiWrap Face Protection	20	\$219.95



Hy-Tape®

The Original Pink Tape®

• LATEX FREE •

- Water-resistant, washable tape suited for use with ET tubes
- Conforms to body contours and adheres firmly to oily or hairy skin
- Will not break down over time allowing skin to remain intact, promoting faster healing and reduce infection
- Individually wrapped rolls available in four widths: 0.5", 1", 1.5", 2"

Item	Description	Qty	\$
9-0075-05	Hy-Tape Roll / 0.5" x 5 yd	36	\$64.95
9-0075-10	Hy-Tape Roll / 1" x 5 yd	36	\$133.95
9-0075-15	Hy-Tape Roll / 1.5" x 5 yd	36	\$198.95
9-0075-20	Hy-Tape Roll / 2" x 5 yd	36	\$260.95



Disposable Nose Clip

Comfortable Yet Secure

• LATEX FREE • DISPOSABLE •

- Soft, comfortable nose cushion
- Ideal for use during breathing treatments, with peak flow meters and pulmonary function studies
- Economical bulk packaging

Item	Description	Qty	\$
9-0134-44	Disposable Nose Clip	100	\$34.95

Reusable Covered Positioning Pads

Leading Manufacturer of Hospital Cushions for Over 40 Years

• LATEX FREE • REUSABLE •

- Made of high quality durable urethane foam
- Safe for OR and OB conductive use
- Custom sizes are available for special order
- Soft black vinyl anti-static covers
- Easily cleaned

Item	Description	Size	Qty	\$
9-0018-01	Small Wedge	5" x 7" x 17"	1	\$60.95
9-0018-02	Large Wedge	8" x 8" x 18"	1	\$84.95
9-0018-03	Small Head Cradle	6.25" x 7" x 3.5"	1	\$60.95
9-0018-04	Large Head Cradle	8" x 9" x 4.5"	1	\$84.95
9-0018-05	Donut Head Pad	4" x 2" x 1.5"	1	\$35.95
9-0018-06	Donut Head Pad	5.5" x 2" x 2"	1	\$47.95
9-0018-07	Donut Head Pad	7" x 3" x 1.5"	1	\$47.95
9-0018-08	Donut Head Pad	9" x 4" x 2"	1	\$47.95
9-0018-09	Donut Head Pad	10" x 6" x 2"	1	\$47.95
9-0018-10	Donut Head Pad	11" x 5.5" x 2"	1	\$55.95
9-0018-11	Positioning Roll	6" x 10"	1	\$47.95
9-0018-12	Positioning Roll	6" x 20"	1	\$60.95
9-0018-13	Positioning Roll	5" x 17"	1	\$84.95



Donut Head Pad



Head Cradle



Wedge



Positioning Roll



MainlineMedical.com
more great products online



9-3104-40

Jaw Elevation Device

Replaces Manual Manipulation

- Non-invasive, easy to use
- Maintains open airway in sedated/anesthetized patients without the need for airway instrumentation
- Frees medical personnel from having to hold the jaw manually
- When left in place after a procedure, reduces post-operative airway complications
- Perfect for use in operating rooms, recovery rooms, office practices, oral surgery/dental offices, interventional radiology suites, MRI and ambulances
- Mandible cups sold separately

Item	Description	Qty	\$
9-3100-10	Jaw Elevation Device	1	\$381.95
9-3104-40	Disposable Mandible Cups	30	\$450.95



PATIENT POSITIONING SOLUTIONS, INC.



Donut Head Pad



Horseshoe Head Pad



Sacral Pad



Clam Shell Heel Protector



Flat Bottom Chest Roll

Gel Positioners

Durable, Antimicrobial Pads

•LATEX FREE • REUSABLE •

- Anti-microbial, anti-bacterial, silicone free and non-allergenic
- Will not leak if punctured
- Aides in pressure re-distribution
- Reduces shear and helps prevent pressure injuries
- Will not bottom out

Item	Description	Size	Qty	\$
9-1200-01	Donut Head Pad	8" x 3" x 2"	1	\$62.95
9-1200-70	Horseshoe Head Pad	8" x 3" x 2"	1	\$59.95
9-3002-20	Sacral Pad	9-3" x 7" x 0.50"	1	\$48.95
9-4002-00	Clam Shell Heel Protector	12.5" x 7.75" x 0.25"	1	\$44.95
9-3004-10	Flat Bottom Chest Roll	12" x 4" x 4"	1	\$81.95
9-3006-20	Flat Bottom Chest Roll	12" x 6" x 6"	1	\$182.95
9-3008-30	Flat Bottom Chest Roll	16" x 4" x 4"	1	\$109.95
9-3009-40	Flat Bottom Chest Roll	16" x 6" x 6"	1	\$246.95

PATIENT POSITIONING SOLUTIONS, INC.



Donut Head Pad



Flat Bottom Positioning Roll



Horseshoe Head Pad

Neonatal & Pediatric Gel Positioning Pads

Extraordinarily Soft Pads for the Tiniest Patients

•LATEX FREE • REUSABLE •

- Helps reduce friction/shear to prevent tissue damage
- Comfort Plus Gel is latex free, radioluscent and antibacterial
- Can be heated or cooled
- Incredibly soft to protect the most sensitive skin and provide ultimate comfort for the tiniest of neonates

Item	Description	Size	Qty	\$
9-0200-00	Donut Head Pad - Neonate	3.25" x 1.5" x 0.75"	1	\$27.95
9-0200-01	Donut Head Pad - Pedi	5.5" x 2.25" x 1.25"	1	\$44.95
9-0201-00	Head Pad - Neonate	3.5" x 1.5" x 0.75"	1	\$27.95
9-0201-01	Horseshoe Head Pad - Pedi	5.5" x 2.25" x 1.25"	1	\$45.95
9-0300-43	Flat Bottom Positioning Roll Neonate/Pedi	4" x 2" x 2"	1	\$22.95
9-0300-45	Flat Bottom Positioning Roll Neonate/Pedi	6" x 2" x 2"	1	\$25.95
9-0300-47	Flat Bottom Positioning Roll Neonate/Pedi	8" x 2" x 2"	1	\$29.95
9-0300-49	Flat Bottom Positioning Roll Neonate/Pedi	10" x 2" x 2"	1	\$32.95
9-0300-51	Flat Bottom Positioning Roll Neonate/Pedi	4" x 3" x 3"	1	\$35.95
9-0300-63	Flat Bottom Positioning Roll Neonate/Pedi	6" x 3" x 3"	1	\$31.95
9-0300-65	Flat Bottom Positioning Roll Neonate/Pedi	8" x 3" x 3"	1	\$37.95
9-0300-69	Flat Bottom Positioning Roll Neonate/Pedi	10" x 3" x 3"	1	\$48.95
9-0300-71	Flat Bottom Positioning Roll Neonate/Pedi	12" x 3" x 3"	1	\$53.95

SunMed



Tongue Seizing Forceps

Grooved Rubber Tips Effectively Grip

•LATEX • REUSABLE •

- Used for holding the tongue in place for better placement of intubation devices
- Made of the highest quality surgical steel
- Latex rubber tips with grooves for a better grip
- Autoclavable

Item	Description	Size	Qty	\$
9-3021-50	Tongue Seizing Forceps	6.75" L	1	\$13.95

SunMed

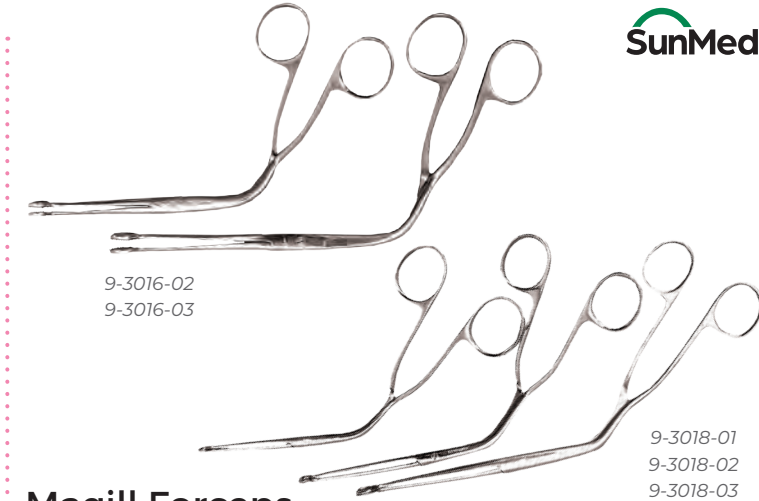

Magill Forceps

Closed & Open Tip Options

•LATEX FREE • REUSABLE •

- Used to guide tracheal tube into the larynx or a nasopharyngeal tube into the esophagus under direct vision
- Made of durable stainless steel
- Autoclavable

Item	Description	Size	Qty	\$
9-3018-01	Infant Closed Tip Magill Forceps	3"	1	\$17.95
9-3018-02	Child Closed Tip Magill Forceps	4"	1	\$17.95
9-3018-03	Adult Closed Tip Magill Forceps	5"	1	\$17.95
9-3016-02	Child Open Tip Magill Forceps	4.5"	1	\$17.95
9-3016-03	Adult Open Tip Magill Forceps	5.5"	1	\$17.95

SunMed



IGuard™ Eye Protector

Non-Allergenic Adhesive

•LATEX FREE • STERILE • DISPOSABLE •

- Provides comfortable, effective patient eye protection
- Available in adult and pediatric sizes
- Non-allergenic adhesive
- Individually packaged

Item	Description	Size	Qty	\$
9-0210-00	IGuard	Adult	25	\$132.95
9-0210-21	IGuard	Pediatric	25	\$134.95
9-0210-20	Double Foam IGuard	Adult	25	\$134.95

SunMed

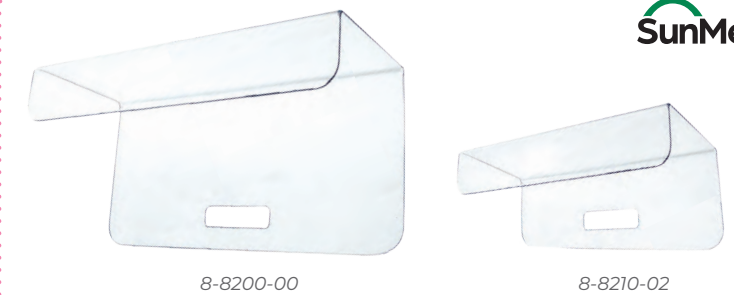

Surgical Patient Arm & Leg Shield

X-Ray Transparent, MRI Compatible

•LATEX FREE • REUSABLE •

- Slides under mattress of bed or stretcher to safely secure arms and legs
- Protects IV, blood pressure cuff or CVP line from being compressed
- X-ray transparent and MRI compatible
- Durable crystal-clear acrylic can be easily cleaned
- Convenient hanger handle

Item	Description	Size	Qty	\$
8-8200-00	Arm & Leg Shield, Large	7.5" W x 5.5" H x 10.5" L	1	\$43.95
8-8210-02	Arm & Leg Shield, Small	15.5" W x 7.5" H x 9" L	1	\$30.95



Manual Positioner Shown
9-4420-02

Epidural Positioning Device

Safe & Comfortable Patient Positioning

- Increases efficiency in thoracic, lumbar and cervical placement by gently encouraging flexion while maintaining a solid, stable position
- Intuitive to use and easy to set up, clean and transport between rooms
- Convenient, disposable face and arm rest covers make for fast and sanitary changeovers between uses
- Fits a variety of body sizes and weight - holds up to 600 lbs
- Single foot pedal easily locks or unlocks all four casters

Addresses Common Safety Concerns:

- The nurse holding the patient may not physically be able to maintain the position needed or to hold the full weight of the patient
- Patient may be tense or attempt to move if they feel uncomfortable which can result in injury or improper placement
- Patient may experience vertigo or nausea causing them to lose position
- Allows clinical staff to be hands-free if needed to assist the anesthesiologist more readily

Item	Description	Qty	\$
9-4400-01	Electric Epidural Positioning Device	1	\$9,739.95
9-4420-02	Manual epidural Position Device	1	\$3,894.95
9-4400-05	Face Rest Covers	25	\$22.95
9-4400-06	Face Rest Covers	200	\$173.95

Manual Epidural Positioning Device

180° Adjustable Face Rest
Tilts to attain and maintain proper cervical flexion

Adjustable Torso Support
Increase lumbar and thoracic flexion with simple adjustments while the chest support immobilizes back

6 Position Adjustable Arm Rest
Height adjustable from 32" - 43"
Allows patient to rest arms naturally and provides stability

Positive Locking Clamp
Quickly locks with one turn

7 Position Adjustable Foot Rest
Height adjustable from 10.5" - 19.5"
Accommodates wide range of body sizes

Double Wheel Casters
Securely lock and also allows for smooth transport



Electric Epidural Positioning Device

180° Adjustable Face Rest
With repositionable pillow for use during cervical, lumbar and thoracic placement

Adjustable Torso Support
Increase lumbar and thoracic flexion with simple adjustments while the chest support immobilizes back

Electric Hand Held Control
Ergonomic and easy to use, controls both midsection and foot rest adjustments

Battery
Rechargeable battery, lasts up to 100 cycles

Adjustable Foot Rest
Adjusts to the required height with hand control to accommodate a wide range of patients

High Quality Casters
Low profile caster locks, conveniently tucked out of the way, easy to access for locking and releasing



CASTrCARD® for Anesthesia Machines

Move Equipment Without Wheel Obstructions

• LATEX FREE •

- Durable ring fits over casters to prevent wheel obstructions
- Safely pushes aside hoses, cables and cords
- Protects expensive hoses, cables and cords from being tangled or run over by heavy equipment
- One piece design is quick and simple to install
- Constructed of high impact polypropylene

Small CASTrGARD

Compatibility: Datex-Ohmeda (GE), Ulco and Dräger (except models listed for medium & large)

Item	Description	Caster Size	Qty	\$
9-45SM-Y	Sm CASTrGARD, Yellow	Up to 5"	1 set	\$183.95
9-45SM-G	Sm CASTrGARD, Gray	Up to 5"	1 set	\$183.95
9-45SM-LB	Sm CASTrGARD, Lt Blue	Up to 5"	1 set	\$183.95
9-45SM-R	Sm CASTrGARD, Red	Up to 5"	1 set	\$183.95

Medium CASTrGARD

Compatibility: Dräger Narkomed GS: 6000/6400, 2A, 2B, 2C, 3, 4 Mobile

Item	Description	Caster Size	Qty	\$
9-456MD-G	Med CASTrGARD, Gray	5"-6"	1 set	\$183.95
9-456MD-LB	Med CASTrGARD, Lt Blue	5"-6"	1 set	\$183.95

Large CASTrGARD

Compatibility: Datascope, Dräger GS: 2A, 2B, 2C, 3, 4, Mobile

Item	Description	Caster Size	Qty	\$
9-67LG-Y	Lg CASTrGARD, Yellow	5"-7.1"	1 set	\$183.95
9-67LG-G	Lg CASTrGARD, Gray	5"-7.1"	1 set	\$183.95
9-67LG-LB	Lg CASTrGARD, Lt Blue	5"-7.1"	1 set	\$183.95
9-67LG-R	Lg CASTrGARD, Red	5"-7.1"	1 set	\$183.95



Safely pushes cords and hoses out of the way as equipment is moved

Durable one piece design makes it easy to install and use



Available in three convenient sizes and sold 4 per set

Anesthesia Equipment Cover

Maintain Clean Work Surfaces

• LATEX FREE • DISPOSABLE •

- Prevent cross-contamination with impervious, disposable clear covers
- Tear-away pockets for trash and disposables
- Provides clean work surface to lay out equipment and instruments that are ready to use
- Designed with tear-away pouches and trash bags for contaminated and disposable device collection
- Available in 3 configurations to fit virtually any anesthesia set up

Item	Description	Qty	\$
4-0010-01	Anesthesia Work Surface Cover w/ Pockets	100	\$532.95
4-0010-02	Complete Anesthesia Cover Kit for: Machine, Monitor, Keyboard, Mouse	50	\$1,796.95
4-0010-03	Anesthesia Monitor Cover	150	\$798.95



4-0010-01



4-0010-02



Infu-Surg® Pressure Infusion Bag

#1 Manufacturer of Pressure Infusion Bags

• LATEX FREE • DISPOSABLE •

- Hook single hand enables loading
- 3-way stopcock ensures precise control of pressure
- 360° view of the color-coded gauge facilitates accurate pressure monitoring while the safety pressure relief valve prevents over-inflation

Item	Description	Size	Qty	\$
4005H	Infu-Surg Pressure Infusion Bag w/ Hook	500 mL	5	\$59.95
4010H	Infu-Surg Pressure Infusion Bag w/ Hook	1000 mL	5	\$64.95
4030	Infu-Surg Pressure Infusion Bag w/ Hook	3000 mL	5	\$74.95



Stopcock & Bulb



Hook



Color-coded Gauge



Infusable Pressure Infusor Bag

Economical IV Solution Bag

• LATEX FREE • DISPOSABLE •

- Helps prevent the exposure to blood stream infections
- Easy to read gauge
- Pocket netting allows for clear view of fluid levels
- Stopcock does not leak in closed position
- Large bulb with rapid recovery for quick and easy inflation
- Fitted seal prevents leakage
- Patient-dedicated to minimize the spread of nosocomial infections via touch contamination

Item	Description	Size	Qty	\$
9-8000-12	Infusable Pressure Infusor Bag	500 mL	12	\$186.95
9-8000-48	Infusable Pressure Infusor Bag	500 mL	48	\$999.95
9-9000-12	Infusable Pressure Infusor Bag	1000 mL	12	\$287.95
9-9500-12	Infusable Pressure Infusor Bag	3000 mL	12	\$665.95



Nylon netting makes loading easy and permits a clear view of fluid level

Smart Stack Patient Care Stands

Innovative Space Saving Design

- Space-saving base design allows for neatly storing and transporting multiple stands
- Durable, sturdy powder-coated aluminum accommodates increased weight capacity
- One-handed height adjustable pole extends up to 93"
- Large, smooth neoprene casters move quietly on all floor surfaces (2 locking, 3 non-locking)
- 4 Fixed ram-horn hooks (maximum 50 lbs capacity)
- Storage basket is convenient for transporting supplies and charts
- Universal equipment stand designed for CPAP and BiPAP units

Item	Description	Base	Height	Qty	\$
7-2400-02	Smart Stack Patient Care Stand	24"	61"-93"	1	\$292.95
7-2400-03	Smart Stack Basket	--	--	1	\$65.95
7-2400-04	Universal Equipment Stand: Smart Stack Base, Equipment Platform, Storage Basket	24"	61"-93"	1	\$484.95



7-2400-02
Bases nest together neatly for space saving storage



7-2400-03
Basket attaches to the pole to carry supplies and charts



Easy, one-handed height adjustment

Provita® IV Poles

Affordable, Adjustable Patient Care Stands

- Knob adjustment for height range of 54" - 78"
- Four sturdy fixed hooks and five rolling lockable casters
- Pediatric pole features colorful design to help create a more comfortable setting in the patient area
- Handle with grip for easy transport and steering
- Bottle holder

Item	Description	Base	Height	Qty	\$
7-2400-05	Provita IV Pole	25"	54"-78"	1	\$71.95
7-2400-06	Provita IV Pole, Pediatric	25"	54"-78"	1	\$124.95
7-2400-03	Provita IV Pole Basket	--	--	1	\$65.95



7-2400-05
Bottle holder and handle come standard



7-2400-03
Basket attaches to the pole to carry supplies and charts



Open-top hooks make for easy IV bag hanging and removal

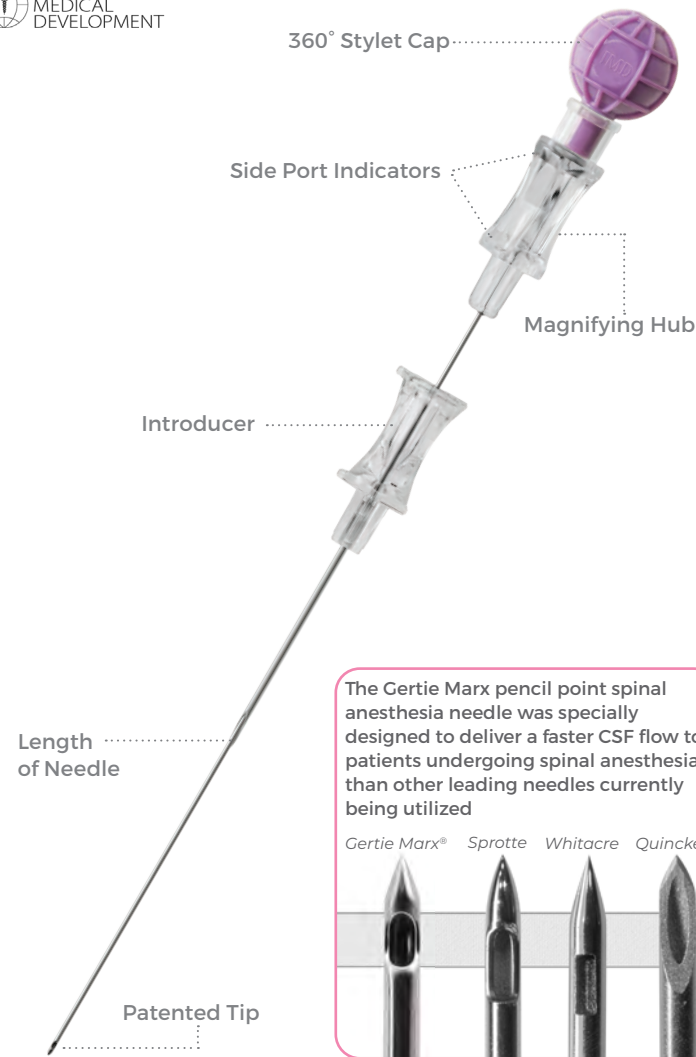

Gertie Marx® Anesthesia Needles

Patented, Pencil Point Tip for Superb Performance

- **STERILE** • **DISPOSABLE** •
- Improved delivery system for regional anesthesia
- Features raised side port indicators, enabling detection of side port at all times
- 360° Rotating stylet cap can be inserted in any position; alignment not necessary and saves time when repeated withdraw and reinsertion is required
- Magnified window on crystal clear hub; earlier recognition of CSF return
- Unique stylet cap with raised lines provides secure grip, even with gloves
- Only patented tip in the USA; very distinct "pop" when dura is punctured
- Available in wide variety of sizes – smaller sizes for pediatric applications, larger sizes for obese and morbidly obese patients; reduces the number of failed blocks due to insufficient length for the CSF technique

Spinal Anesthesia Needle

Item	Description	Size	Qty	\$
9-2490-01	3.5" Needle w/ Introducer	24 G x 90 mm	10	\$118.95
9-4101-01	4" Needle w/ Introducer	24 G x 101 mm	10	\$118.95
9-4124-01	5" Needle w/ Introducer	24 G x 124 mm	10	\$141.95
9-4150-01	6" Needle w/ Introducer	24 G x 150 mm	10	\$155.95
9-2590-01	3.5" Needle w/ Introducer	25 G x 90 mm	10	\$118.95
9-2510-01	4" Needle w/ Introducer	25 G x 101 mm	10	\$118.95
9-5124-01	5" Needle w/ Introducer	25 G x 124 mm	10	\$141.95
9-5150-01	6" Needle w/ Introducer	25 G x 150 mm	10	\$155.95
9-5160-01	6.5" Needle w/ Introducer	25 G x 160 mm	10	\$155.95
9-5190-01	7.5" Needle w/ Introducer	25 G x 190 mm	10	\$202.95
9-5215-01	8.5" Needle w/ Introducer	25 G x 215 mm	10	\$243.95
9-2690-01	3.5" Needle w/ Introducer	26 G x 90 mm	10	\$118.95
9-6101-01	4" Needle w/ Introducer	26 G x 101 mm	10	\$118.95
9-6124-01	5" Needle w/ Introducer	26 G x 124 mm	10	\$141.95
9-2790-01	3.5" Needle w/ Introducer	27 G x 90 mm	10	\$118.95
9-7124-01	5" Needle w/ Introducer	27 G x 124 mm	10	\$141.95

Lumbar Puncture & Myelograms

Item	Description	Size	Qty	\$
9-2250-01	2" Needle w/ Introducer	22 G x 50 mm	10	\$118.95
9-2270-01	2.75" Needle w/ Introducer	22 G x 70 mm	10	\$118.95
9-2290-01	3.5" Needle w/ Introducer	22 G x 90 mm	10	\$118.95
9-2124-01	5" Needle w/ Introducer	22 G x 124 mm	10	\$141.95
9-2150-01	6" Needle w/ Introducer	22 G x 150 mm	10	\$155.95
9-2180-01	7.5" Needle w/ Introducer	22 G x 190 mm	10	\$202.95

Pediatric Needle

Item	Description	Size	Qty	\$
9-2250-01	2" Needle w/ Introducer	22 G x 50 mm	10	\$118.95
9-2270-01	2.75" Needle w/ Introducer	22 G x 70 mm	10	\$118.95
9-2290-01	3.5" Needle w/ Introducer	22 G x 90 mm	10	\$118.95
9-2450-01	3.5" Needle w/ Introducer	24 G x 50 mm	10	\$118.95
9-2550-01	2" Needle w/ Introducer	25 G x 50 mm	10	\$118.95
9-2650-01	2" Needle w/ Introducer	26 G x 50 mm	10	\$118.95
9-2750-01	2" Needle w/ Introducer	27 G x 50 mm	10	\$118.95

Epidural / Tuohy Needle

Item	Description	Size	Qty	\$
9-1735-01	Epidural/Tuohy Needle	17 G x 3.5"	10	\$81.95
9-1750-01	Epidural/Tuohy Needle	17 G x 5"	10	\$108.95
9-1760-01	Epidural/Tuohy Needle	17 G x 6"	10	\$108.95
9-1770-01	Epidural/Tuohy Needle	17 G x 7"	10	\$148.95

Mini Combined Spinal & Epidural Set

Item	Description	Qty	\$
9-2612-17	26 G x 124 mm / 5" Spinal Needle 17 G x 3.5" Epidural Needle	10	\$243.35
9-2516-17	25 G x 160 mm / 6.5" Spinal Needle 17 G x 5" Epidural Needle	10	\$270.30
9-2716-17	27 G x 160 mm / 6.5" Spinal Needle 17 G x 5" Epidural Needle	10	\$270.30
9-2519-17	25 G x 190 mm / 7.5" Spinal Needle 17 G x 6" Epidural Needle	10	\$270.30
9-2515-17	25 G x 215 mm / 8.5" Spinal Needle 17 G x 7" Epidural Needle	10	\$324.35



Sprotte Needles

Designed to Separate Instead of Cut Dural Fibers

- **LATEX FREE** • **STERILE** • **DISPOSABLE** •
- Highly polished pencil point tip
- Smooth lateral eye
- Color coded for gauge size
- Available with introducer

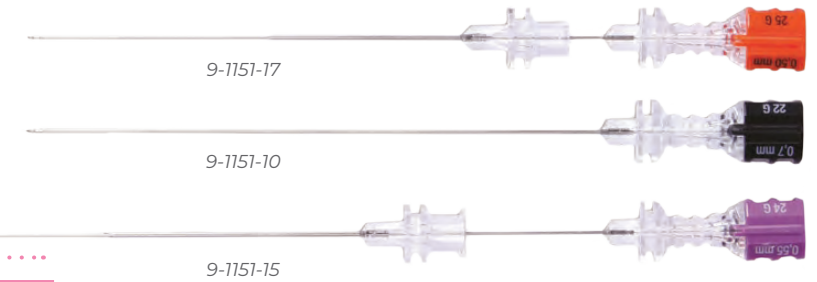

Needle Only

Item	Description	Size	Qty	\$
9-1151-06	Sprotte Needle	20G x 3.5"	25	\$348.95
9-1151-07	Sprotte Needle	21G x 3.5"	25	\$325.95
9-1151-09	Sprotte Needle	22G x 3.5"	25	\$325.95
9-1151-10	Sprotte Needle	22G x 4.75"	10	\$177.95
9-1151-11	Sprotte Needle	24G x 1"	25	\$325.95
9-1151-13	Sprotte Needle	24G x 3"	25	\$325.95
9-1151-14	Sprotte Needle	24G x 3.5"	25	\$325.95
9-1151-15	Sprotte Needle	24G x 4.75"	10	\$182.95
9-1151-16	Sprotte Needle	24G x 6"	10	\$219.95
9-1151-17	Sprotte Needle	25G x 4.75"	10	\$182.95

Needle with Introducer

Item	Description	Size	Qty	\$
9-1151-18	Sprotte Needle w/ Introducer	24G x 3.5"	25	\$365.95
9-1151-19	Sprotte Needle w/ Introducer	24G x 4"	25	\$350.95
9-1151-20	Sprotte Needle w/ Introducer	24G x 4.75"	10	\$200.95
9-1151-21	Sprotte Needle w/ Introducer	24G x 6"	10	\$249.95
9-1151-22	Sprotte Needle w/ Introducer	25G x 3.5"	25	\$372.95

Tuohy Needles

Ideal for Use with Obese Patients

- **LATEX FREE** • **STERILE** • **DISPOSABLE** •

- Extra long length compared to those normally found in pre-made kits



Item	Description	Size	Qty	\$
9-1400-23	Tuohy Needle - Long	17G x 4.5"	10	\$240.95
9-1401-24	Tuohy Needle - Extra Long	17G x 6"	10	\$282.95

ViaValve® Safety IV Catheters with Blood Control

Help Reduce Risk of Blood Exposure & Contamination

- **LATEX FREE** • **STERILE** • **DISPOSABLE** •

- Unique valve inside the catheter hub impedes blood flow from the patient's vein upon initial venipuncture
- Once inserted, the catheter is activated by attaching the luer fitting of an infusion line which opens the valve to allow unrestricted flow
- Guard surrounds the retracted introducer needle for safe handling and disposal, thus preventing accidental needle sticks
- Ocrilon polyurethane catheter softens and becomes more pliable, allowing longer in-dwell
- Ribbed hub design facilitates secure catheterization



Item	Description	Size	Flow Rate	Qty	\$
9-3260-22	ViaValve Safety IV Catheter - Blue	22G x 1"	38 mL/min	200	\$500.95
9-3262-16	ViaValve Safety IV Catheter - Gray	16G x 1.25"	220 mL/min	200	\$500.95
9-3263-24	ViaValve Safety IV Catheter - Yellow	24G x 0.625"	24 mL/min	200	\$500.95
9-3265-18	ViaValve Safety IV Catheter - Green	18G x 1.25"	110 mL/min	200	\$500.95
9-3266-20	ViaValve Safety IV Catheter - Pink	20G x 1.25"	65 mL/min	200	\$500.95
9-3267-21	ViaValve Safety IV Catheter - Pink	20G x 1"	63 mL/min	200	\$500.95
9-3268-14	ViaValve Safety IV Catheter - Orange	14G x 1.25"	360 mL/min	200	\$500.95





9-8907-14

Vapofil™ Keyed Agent Adapter

Works from the First Drop to the Last

- Rapid filling without airlocks or drips
- Flexible outer sleeve
- Reinforced brass tubing inner sleeve
- Anti-pollution plug
- Less waste
- For use with keyed or pinned older model machines

Item	Description	Qty	\$
9-8907-11	Vapofil Forane/Isflurane Adapter, Purple	1	\$79.95
9-8907-14	Vapofil Ultarane/Sevoflurane Adapter, Yellow	1	\$79.95



AntiSpil™ Vaporizer Filler Adapter

Top Line of Defense in Preventing Anesthetic Agent Spills

- Reduces the potential of overflow at funnel port or dripping
- Helps eliminate OR pollution
- Stays in bottle until it is empty
- For use with keyed or pinned older model machines

Item	Description	Qty	\$
9-9010-66	AntiSpil Forane/Isflurane Adapter, Purple	1	\$35.95

smiths medical



SODASORB® CO₂ Absorbent

World's Leading Brand of CO₂ Absorbent

- Color changes when absorbent capacity is exhausted
- Low dusting - conforms to strict hardness standard
- Three packaging options available

Item	Description	Qty	\$
7-0088-60	Sodasorb 2.5 lb Canister Pak (Refill Bag)	12	\$92.95
7-0088-70	Sodasorb 3 lb Pre-Pak (Canister Discs)	12	\$138.95
7-0088-80	Sodasorb 5 Gallon Pail	1	\$89.95

Pre-Cut Labels & Label Tape

Proper Drug Labeling Meets ASTM Standards

- Labels and tape are color-coded by drug category
- Show expiration date, expiration time, and initials of healthcare worker
- Packaged on rolls for easy use and dispensing

Shown Actual Size

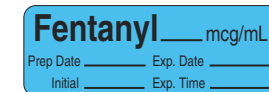

Pre-cut Labels
1/2" x 1-1/2"
500" Roll

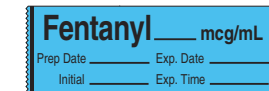

Label Tape
1/2" x 1-1/2"
500" Roll

Item	Description	Qty	\$
See Below	Pre-Cut Labels	1 Roll	\$9.95
See Below	Label Tape	1 Roll	\$9.95

Local Anesthetics

Gray with black imprint

Pre-cut Labels	Label Tape	Description
7-1030-20	7-2030-20	Bupivacaine ___ mg/mL
7-1030-70	7-2030-70	Carbocaine ___ %
7-1030-50	7-2030-50	Cocaine ___ %
7-1030-03	7-2030-03	Lidocaine 1%
7-1030-04	7-2030-04	Lidocaine 2%
7-1030-60	7-2030-60	Marcaine ___ %
7-1030-01	7-2030-01	Marcaine ___ mg/mL
7-1030-90	7-2030-90	Naropin ___ mg/mL
7-1030-40	7-2030-40	Nesacaine ___ %
7-1030-10	7-2030-10	Procaine ___ mg/mL
7-1030-30	7-2030-30	Xylocaine ___ %
7-1030-02	7-2030-02	Xylocaine ___ mg/mL

Anticholinergic Agents

Green with black imprint

Pre-cut Labels	Label Tape	Description
7-1031-00	7-2031-00	Atropine ___ mg/mL
7-1031-40	7-2031-00	Atropine 0.4 mg/mL
7-1031-30	7-2031-00	Atropine Sulfate ___ mg/mL
7-1031-10	7-2031-00	Glycopyrrolate ___ mg/mL
7-1031-50	7-2031-00	Glycopyrrolate 0.2 mg/mL
7-1031-20	7-2031-00	Robinul ___ mg/mL

Narcotics

Blue with black imprint

Pre-cut Labels	Label Tape	Description
7-1024-17	7-2024-17	Alfentanil ___ mcg/mL
7-1024-80	7-2024-80	Demerol ___ mg/mL
7-1024-14	7-2024-14	Dilaudid ___ mg/mL
7-1024-15	7-2024-15	Duramorph ___ mg/mL
7-1024-13	7-2024-13	Fentanyl ___ mcg/mL
7-1024-20	7-2024-20	Fentanyl 50 mcg/mL
7-1024-16	7-2024-16	Hydromorphone ___ mg/mL
7-1024-02	7-2024-02	Meperidine ___ mg/mL
7-1024-30	7-2024-30	Morphine ___ mg/mL
7-1024-40	7-2024-40	Nisentil ___ mg/mL
7-1024-70	7-2024-70	Nubain ___ mg/mL
7-1024-11	7-2024-11	Remifentanyl ___ mcg/mL
7-1024-10	7-2024-10	Stadol ___ mg/mL
7-1024-60	7-2024-60	Sublimaze ___ mcg/mL
7-1024-90	7-2024-90	Sufenta ___ mcg/mL
7-1024-19	7-2024-19	Sufentanil ___ mcg/mL
7-1024-50	7-2024-50	Sufentanil ___ mg/mL
7-1024-12	7-2024-12	Ultiva ___ mcg/mL

Narcotic Antagonists

Blue and white diagonal stripe with black imprint

Pre-cut Labels	Label Tape	Description
7-1025-00	7-0025-00	Levallorphan ___ mg/mL
7-1025-10	7-0025-10	Naloxone ___ mg/mL
7-1025-20	7-0025-20	Narcan ___ mg/mL

Beta Blockers

Copper bar with reverse imprint

Pre-cut Labels	Label Tape	Description
7-1033-30	7-2033-30	Esmolol ___ mcg/mL
7-1033-10	7-2033-10	Esmolol ___ mg/mL
7-1033-20	7-2033-20	Esmolol 10 mg/mL
7-1033-40	7-2033-40	Labetalol ___ mg/mL
7-1033-50	7-2033-50	Labetalol 5 mg/mL
7-1033-60	7-2033-60	Metoprolol ___ mg/mL
7-1033-70	7-2033-70	Metoprolol 1 mg/mL

Major Sedatives

Salmon with black imprint

Pre-cut Labels	Label Tape	Description
7-1026-10	7-2026-10	Chlorpromazine ___ mg/mL
7-1026-30	7-2026-30	Droperidol ___ mg/mL
7-1026-20	7-2026-20	Inapsine ___ mg/mL

Sedatives

Orange with black imprint

Pre-cut Labels	Label Tape	Description
7-1021-00	7-2021-00	Diazepam ___ mg/mL
7-1021-10	7-2021-10	Lorazepam ___ mg/mL
7-1021-20	7-2021-20	Midazolam ___ mg/mL
7-1021-70	7-2021-70	Midazolam 1 mg/mL
7-1021-40	7-2021-40	Valium ___ mg/mL
7-1021-30	7-2021-30	Versed ___ mg/mL
7-1021-50	7-2021-50	Versed 1 mg/mL

Induction Agents

Yellow with black imprint

Pre-cut Labels	Label Tape	Description
7-1020-80	7-2020-80	Brevital 10 mg/mL
7-1020-90	7-2020-90	Diprivan Propofol 10 mg/mL
7-1020-00	7-2020-00	Etomidate ___ mg/mL
7-1020-01	7-2020-01	Ketalar ___ mg/mL
7-1020-10	7-2020-10	Ketamine ___ mg/mL
7-1020-02	7-2020-02	Methohexital 10 mg/mL
7-1020-20	7-2020-20	Methohexital 1%
7-1020-03	7-2020-03	Pentobarbital ___ mg/mL
7-1020-70	7-2020-70	Pentothal ___ mg/mL
7-1020-04	7-2020-04	Pentothal 25 mg/mL
7-1020-50	7-2020-50	Propofol ___ mg/mL
7-1020-30	7-2020-30	Thiamylal 2.5%
7-1020-40	7-2020-40	Thiopental 2.5%

MainlineMedical.com
more great products online

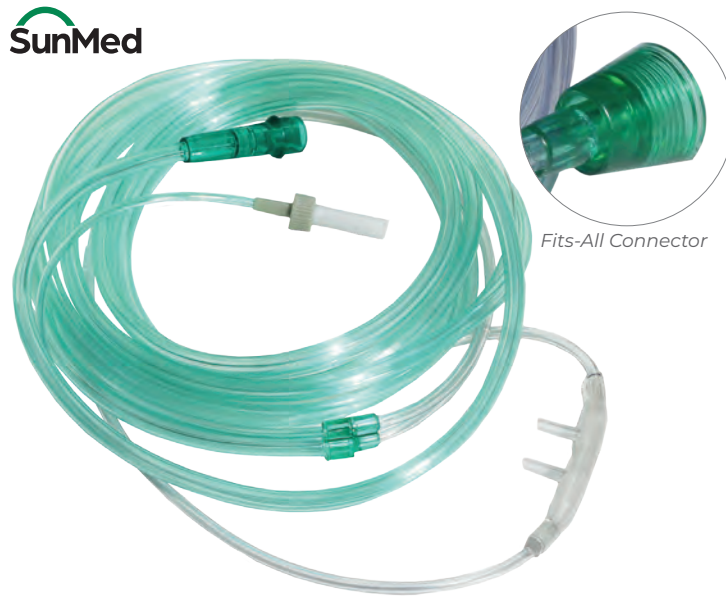

Fits-All Connector

EtCO₂ / O₂ Delivery Nasal Cannula

Simultaneously Provide Oxygen While Capturing End Tidal Gas

- LATEX FREE • DISPOSABLE •
- Dual nasal cannula simultaneously provides oxygen to both nostrils while obtaining CO₂ sampling during spontaneous breathing
- Effectively captures undiluted end tidal gas sample
- Designed to prevent mixing of fresh oxygen with CO₂
- 3-Channel tubing prevents kinking
- Includes male/female adapter with luer lock connector
- Available with Fits-All Connector for O₂ or oxygen connections

Item	Description	Size	Length	25/Pk \$
4107	EtCO ₂ Cannula	Adult	7'	\$53.95
4107F	EtCO ₂ Cannula w/ Fits-All Connector	Adult	7'	\$56.95
4110	EtCO ₂ Cannula	Adult	10'	\$62.95
4110F	EtCO ₂ Cannula w/ Fits-All Connector	Adult	10'	\$66.95
4114	EtCO ₂ Cannula	Adult	14'	\$71.95
4114F	EtCO ₂ Cannula w/ Fits-All Connector	Adult	14'	\$74.95



Monitors CO₂

Delivers O₂

EtCO₂ / O₂ Delivery Nasal Cannula

Dual Oxygen Delivery; Dual End Tidal Sampling

- LATEX FREE • DISPOSABLE •
- Designed to provide O₂ to both nostrils and sample CO₂ at the same time
- Dual EtCO₂ sampling ports provide excellent sampling accuracy
- Non-kinking tube ensure, consistent and accurate delivery
- Universal oxygen connector

Item	Description	Size	Length	25/Pk \$
8-3210-23	Male Dual Nasal Cannula w/ Pigtail	Adult	7'	\$68.95
8-3210-24	Female Dual Nasal Cannula w/ Pigtail	Adult	7'	\$68.95
8-3210-25	Male Dual Nasal Cannula w/out Pigtail	Adult	7'	\$68.95
8-3210-26	Female Dual Nasal Cannula w/out Pigtail	Adult	7'	\$68.95
8-3210-27	Male Dual Nasal Cannula	Adult	10'	\$77.95
8-3210-28	Female Dual Nasal Cannula	Adult	10'	\$77.95
8-3210-25	Male Dual Nasal Cannula	Adult	7'	\$68.95
8-3210-26	Female Dual Nasal Cannula	Adult	7'	\$68.95

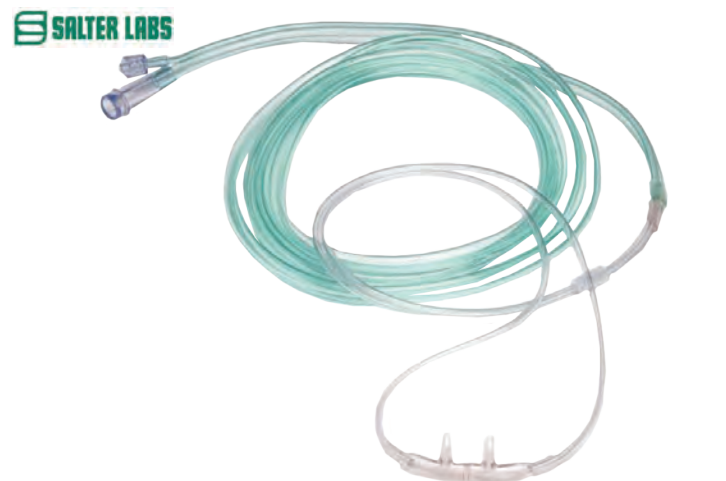

Divided EtCO₂ / O₂ Delivery Nasal Cannula

Capnography Cannula with Soft Tubing

- LATEX FREE • DISPOSABLE •
- Providing true EtCO₂ sampling and provided O₂ delivery without limitations at higher O₂ rates
- Divided design separates gases
- Salter Eyes maintains sampling even during a cannula occlusion

Item	Description	Size	Length	25/Pk \$
49SOFT-7-7-25	Divided Cannula with Male Luer Connector	Adult	7'	\$44.95
49SOFT-TG7-7-25	Divided Cannula with Threaded Grip Connector	Adult	7'	\$46.95



EtCO₂ / O₂ Sampling Cannula with Reflective Connector

Compatible with Leading CPAP Monitors

- LATEX FREE • DISPOSABLE •
- Compatible with Microstream™, Capnostream™ and Oridion™ capnography monitors
- Dual nasal cannula simultaneously provides oxygen to both nostrils while obtaining CO₂ sampling during spontaneous breathing
- Designed to prevent mixing of fresh oxygen with CO₂
- Innovative scoop design suitable for mouth-breathing patients
- 3-Channel tubing prevents kinking
- Adult and pediatric sizes in three tubing lengths
- DEHP free

Filter integrated with reflective connector helps prevent moisture collection

Fits-All O₂ connector comes standard on all sizes and lengths

Scoop design effectively captures end tidal sampling from mouth breathing patients

Soft-Ears™ material ensures superior patient comfort, even during prolonged use



EtCO₂ / O₂ Cannula with Reflective Connector

Item	Description	Size	Length	25/Pk \$
5107F-SE	EtCO ₂ /O ₂ Nasal Cannula	Adult	7'	\$156.95
5110F-SE	EtCO ₂ /O ₂ Nasal Cannula	Adult	10'	\$172.95
5114F-SE	EtCO ₂ /O ₂ Nasal Cannula	Adult	14'	\$189.95
5207F-SE	EtCO ₂ /O ₂ Nasal Cannula	Pediatric	7'	\$198.95
5210F-SE	EtCO ₂ /O ₂ Nasal Cannula	Pediatric	10'	\$218.95
5214F-SE	EtCO ₂ /O ₂ Nasal Cannula	Pediatric	14'	\$240.95

EtCO₂ / O₂ Cannula with Reflective Connector, Scoop

Item	Description	Size	Length	25/Pk \$
5707F-SE	EtCO ₂ /O ₂ Oral/Nasal Cannula	Adult	7'	\$184.95
5710F-SE	EtCO ₂ /O ₂ Oral/Nasal Cannula	Adult	10'	\$203.95
5714F-SE	EtCO ₂ /O ₂ Oral/Nasal Cannula	Adult	14'	\$223.95

Microstream, Capnostream, and Oridion are trademarks of Oridion Medical 1987, Ltd. related to products marketed by Medtronic.

smiths medical



BCI® Capnocheck® II Hand-Held Capnograph

Portable All-In-One Capnograph, Oximeter & CO₂ Monitor

- LATEX FREE • DISPOSABLE •
- Measures ETCO₂, inspired CO₂, respiration rate, SpO₂ and heart rate
- Displays waveforms, trends and numeric values
- Adjustable alarm limits with visual and audible alarms
- Sidestream technology accommodates intubated and non-intubated patients

Item	Description	Qty	\$
8-8400-00	Capnocheck II Complete System	1	\$2,149.95
8-8401-00	Capnocheck II Capnograph ONLY	1	\$1,907.95
8-8400-01	110 V Battery Eliminator	1	\$106.95
8-8400-02	Gas Manifold Filters	10	\$26.95
8-8400-03	Calibration Kit	1	\$188.95
8-8400-04	Pole Mount	1	\$48.95
8-8400-05	Protective Rubber Boot, Carry Strap	1	\$48.95

HUDSON RCI

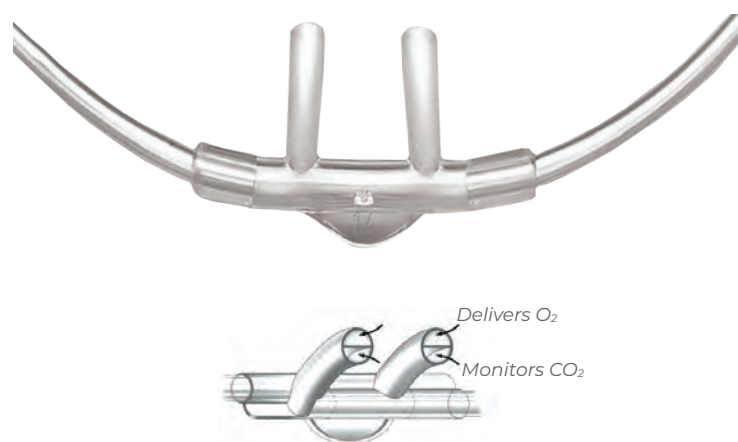

SoftTech® Bi-Flo™ Cannulas

Complete with Gas Sampling Line

- LATEX FREE • DISPOSABLE •
- Allows delivery of oxygen to both nasal prongs and sampling of expired gases from both nares simultaneously
- Three configurations for use with any side stream CO₂
- Each cannula packaged with adapter

Item	Description	O ₂ Length	CO ₂ Length	Qty	\$
8-1843-03	Bi-Flo Cannula w/ Female Luer Lock	7'	3'	25	\$105.95
8-1844-04	Bi-Flo Cannula w/ Male Luer Lock	7'	7'	25	\$122.95
8-1845-05	Bi-Flo Cannula w/ Female Luer Lock	7'	7'	25	\$122.95

smiths medical



Gas Sampling Lines

Male/Female Luer Connectors, 0.05" ID

- LATEX FREE • DISPOSABLE •
- Flexible and kink resistant
- Fits standard luer connections
- Filters not included
- PVC gas sampling lines for ETCO₂ monitoring

Item	Description	Length	Qty	\$
8-5550-79	Sampling Line, Male-Male Connector	10'	50	\$60.95
8-5550-82	Sampling Line, Male-Female Connector	10'	50	\$60.95

SALTER LABS



Comparable to standard orange and long term yellow reflective connectors

Reflective connector compatible with leading monitors

STAT Orange Capnography Cannula with Reflective Connector

True EtCO₂ Sampling with Proven O₂ Delivery

- LATEX FREE • DISPOSABLE •
- Effective capnography at a substantial savings
- Reflective connector compatible with leading capnography monitors
- Designed with 40% less dead space and superior oxygen delivery compared to blow-by designs
- Ergonomic design provides superior comfort and fit on both adult and pediatric faces
- Proprietary hydrophobic 0.2 micron filter protects monitor from biohazards
- Nafion® tubing for high humidity applications

Item	Description	Size	Oral/Nasal	O ₂ Length	CO ₂ Length	Qty	\$
4MSF1-0-6-25	O ₂ /EtCO ₂ Cannula	Adult	Oral/Nasal	2'	6'	25	\$181.95
4MSF1-7-13-25	O ₂ /EtCO ₂ Cannula	Adult	Oral/Nasal	7'	13'	25	\$207.95
4MSF1-7-6-100	O ₂ /EtCO ₂ Cannula	Adult	Oral/Nasal	7'	6'	100	\$756.95
4MSF1-L-7-6-25	O ₂ /EtCO ₂ Cannula	Adult	Oral/Nasal	7'	6'	25	\$296.95
4MSF2-PED-7-6-25	O ₂ /EtCO ₂ Cannula	Pediatric	Oral/Nasal	7"	6'	25	\$178.95
4MSF3-6-25	EtCO ₂ Cannula	Adult	Nasal	-	6'	25	\$167.95
4MSF3-7-6-25	O ₂ /EtCO ₂ Cannula	Adult	Nasal	7'	6'	25	\$175.95
4MSF5-13-25	EtCO ₂ Sampling Line w/ Adapter	-	-	-	13'	25	\$239.95
4MSF5-6-25	EtCO ₂ Sampling Line w/ Adapter	-	-	-	6'	25	\$216.95
4MSF8-13-25	EtCO ₂ Sampling Line	-	-	-	13'	25	\$152.95
4MSF8-6-25	EtCO ₂ Sampling Line	-	-	-	6'	25	\$152.95



Capnography Dual Face Masks

Prevents Mixing of O₂ & CO₂ for a More Accurate Reading

- LATEX FREE • DISPOSABLE •
- Provides breath by breath patient ventilator status
- Star lumen tubing ensures the flow of oxygen is maintained even if the tube is kinked
- Mask is made of transparent soft PVC
- 50 per Case

Female Connector

Item	Description	Size	50/Pk \$
8-3210-34	Mask, Nose Clip, Female Connector	Adult	\$224.95
8-3210-36	Mask, Nose Clip, Filter, Female Connector	Adult	\$294.95
8-3212-42	Mask, Female Connector	Pediatric	\$321.95
8-3212-44	Mask, Female Connector	Pediatric	\$391.95

Male Connector

Item	Description	Size	50/Pk \$
8-3210-35	Mask, Nose Clip, Male Connector	Adult	\$224.95
8-3210-37	Mask, Nose Clip, Filter, Male Connector	Adult	\$294.95
8-3212-43	Mask, Male Connector	Pediatric	\$321.95
8-3212-45	Mask, Mask, Male Connector	Pediatric	\$391.95



CapnoVue Capnography Masks

ETCO₂ Sampling with Oxygen Delivery

- LATEX FREE • DISPOSABLE •
- Improved capnography with oral/nasal sampling for mouth breathers and upper GI cases
- Can deliver higher oxygen delivery for patients where more aggressive oxygenation is needed
- Luer ports located at both expiratory ports separates CO₂ from O₂ for clean signals
- Trumpet or universal thread grip O₂ connector options
- Oral scope opening available

Item	Size	Length	Connector	Qty	\$
4727-7-0-50	Adult	7'	Trumpet	50	\$207.95
4727-14-0-50	Adult	14'	Trumpet	50	\$238.95
4727TG-7-0-50	Adult	7'	Threaded	50	\$207.95
4727TG-14-0-50	Adult	14'	Threaded	50	\$238.95

With Oral Scope

Item	Size	Length	Connector	Qty	\$
4737-7-0-50	Adult	7'	Trumpet	50	\$265.95
4737-14-0-50	Adult	14'	Trumpet	50	\$289.95
4737TG-7-0-50	Adult	7'	Threaded	50	\$280.95
4737TG-14-0-50	Adult	14'	Threaded	50	\$304.95
4733-7-0-50	Pediatric	7'	Trumpet	50	\$318.95



High Concentration Non-Rebreather & Partial Rebreather Masks

Soft, Anatomical Form Encourages Patient Use

- LATEX FREE • DISPOSABLE •
- Elongated face mask design
- Safety vent option available
- Elastic head strap and over-the-ear styles
- Adult & pediatric face masks



Non-Rebreather Masks

Item	Description	Size	Qty	\$
8130-9-25	9' Tubing, Safety Vent	Adult	25	\$32.95
1130TG-7-50	7' Tubing, Threaded Grip, Safety Vent	Pediatric	50	\$126.95
8030-7-50	7' Tubing, Safety Vent, Cannula Style Strap	Adult	50	\$48.95
8040-7-50	7' Tubing, Cannula Style Securement	Adult	50	\$64.95
8130TG-7-50	7' Tubing, Threaded Grip, Safety Vent, Elastic Strap	Adult	50	\$64.95

Partial Rebreather Masks

Item	Description	Size	Qty	\$
1102-7-50	High Concentration, Partial Rebreather	Adult	50	\$35.95
1127-7-50	High Concentration, Partial Rebreather	Pediatric	50	\$99.95

Aloha Nasal Pillow CPAP

Exceptional CPAP Performance & Comfort

- LATEX FREE •
- Designed for freedom of movement during sleep while remaining stable
- Aloha provides user with adjustability and control to improve seal and comfort
- Ball and swivel joint helps reduce tugging on mask at hose connection, helping active sleepers stay more comfortable
- Depth and angle of nasal pillows are adjustable for the best patient fit and comfort with exclusive Arched-Track Technology
- Design and operation of Aloha system is quiet and less disruptive compared to other CPAP systems
- Headgear is lightweight and stable with minimal contact on face for increased comfort and clear line of sight
- Hose can be worn over top of head



Aloha provides superior comfort!
Patient can freely move without compromising oxygen delivery.



Compact yet incredibly effective

Item	Description	Size	Qty	\$
ALO135	9' Tubing, Safety Vent	Large	30	\$850.95
ALO133	7' Tubing, Threaded Grip, Safety Vent	Medium	30	\$850.95
ALO131	7' Tubing, Safety Vent, Cannula Style Strap	Small	30	\$850.95
ALO130	7' Tubing, Cannula Style Securement	-	90	\$1475.95



Fits-All Connector Standard

High Flow O₂ Delivery & Humidifier

High Flow Bubble Humidifier 6-15 LPM

• LATEX FREE • DISPOSABLE •

- Humidifier features 6 PSI (414 mbar) pressure relief valve
- Curved nares made of ultra-soft material for patient comfort
- 3-Channel tubing helps prevent kinking
- Green supply tubing standard
- Cannula features Fits-All Connector

Item	Description	Qty	\$
6900	Bubble Humidifier	10	\$24.95
6907	7' High Flow O ₂ Cannula & Bubble Humidifier	10	\$42.95
6915	15' High Flow O ₂ Cannula & Bubble Humidifier	10	\$55.95



High Flow Oxygen Delivery Cannula

Deliver up to 15 LPM Oxygen

• LATEX FREE • DISPOSABLE •

- Excellent alternative to face mask oxygen delivery for patient comfort
- Designed with 3-channel tubing to prevent kinking
- Three lengths
- Over-the-ear TLC wraps provide additional patient comfort for extended wear
- TLC ear wraps made of closed-cell foam cushioning

Item	Description	Length	Qty	\$
1600HF-7-25	High Flow Cannula	7'	25	\$71.95
1600HF-14-25	High Flow Cannula	14'	25	\$81.95
1600HFTLC-7-25	High Flow Cannula, TLC Wraps	7'	25	\$89.95
1600HFTLC-14-25	High Flow Cannula, TLC Wraps	14'	25	\$91.95
1600HFTLC-25-10	High Flow Cannula, TLC Wraps	25'	10	\$47.95



7100-0-50

7600-0-50

Bubble Humidifiers

Durable and Dependable

• LATEX FREE • DISPOSABLE •

- Dependable, cost effective humidification
- Compatible with all oxygen sources: concentrators, liquid tanks, wall outlets
- 360° diffusion port offers quiet operation with improved hydration and less back-pressure
- 3 and 6 PSI models
- High flow unit accommodates 6 to 15 LPM with audible pressure relief
- Suitable with Salter 1600HF and 16SOFT-HF cannulas

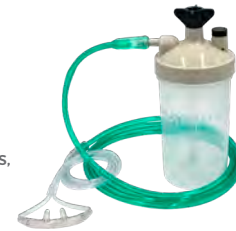

Item	Description	Qty	\$
7100-0-50	350 cc Bubble Humidifier, 3 PSI	50	\$71.95
7600-0-50	350 cc Bubble Humidifier, 6 PSI	50	\$72.95
7900-0-25	350 cc High Flow Bubble Humidifier	25	\$74.95

Soft Oxygen Delivery Cannula

Soft-to-the-Touch Feel Throughout Entire Cannula

• LATEX FREE • DISPOSABLE •

- Face piece, nares and entire length of tubing is ultra soft, delivering exceptional patient comfort
- Soft, pliable, stretchable tubing
- Slide bolo prevents twisting and turning

Item	Description	Length	Qty	\$
16SOFT-4-50	Adult O ₂ Cannula	4'	50	\$22.95
16SOFT-7-50	Adult O ₂ Cannula	7'	50	\$25.95
16SOFT-14-50	Adult O ₂ Cannula	14'	50	\$37.95
16SOFT-25-25	Adult O ₂ Cannula	25'	25	\$39.95
16SOFTTG-7-50	Adult O ₂ Cannula, Thread Grip	7'	50	\$22.95
16SOFTTG-14-50	Adult O ₂ Cannula, Thread Grip	14'	50	\$25.95
16SOFTTG-25-25	Adult O ₂ Cannula, Thread Grip	25'	25	\$37.95



Tender Grips®

Gently Secure Cannula Tubing in Place

• LATEX FREE • DISPOSABLE •

- Soft, skin-toned acrylic securement holds tubing in place
- Typically positioned on cheeks
- Gentle yet effective for infants and adults
- Internal flap allows for cannula adjustment without removing securement
- Sold in pairs

Item	Description	Qty	\$
1005-0-25	Tender Grips Securement	25	\$28.95

Conventional Oxygen Delivery Cannula

Non-Flared Tips, Oxygen Flow up to 6 LPM

• LATEX FREE • DISPOSABLE •

- Ideal for low-flow volumes up to 6 LPM
- Three-channel tubing helps prevent kinking
- With and without supply line

Item	Description	Length	Qty	\$
1057-0-50	Conventional O ₂ Cannula	NA	50	\$21.95
1057B-0-50	Conventional O ₂ Cannula, Barbed Connector	NA	50	\$21.95
1053-4-50	Conventional O ₂ Cannula	4'	50	\$23.95
1053-7-50	Conventional O ₂ Cannula	7'	50	\$25.95
1053-25-25	Conventional O ₂ Cannula	25'	25	\$38.95





Aerosol Therapy Masks

Secure Positioning Plus Patient Comfort

• LATEX FREE •

- Elastic strap head strap
- Tubing not included

Item	Description	Size	Qty	\$
1100-0-50	Aerosol Mask	Adult XL	50	\$23.95
1107-0-10	Aerosol Mask, Valved	Pediatric	10	\$10.95
1113-0-10	Aerosol Mask	Infant	10	\$11.95
8107V-0-10	Aerosol Mask, Valved	Adult	10	\$5.95



FiltaMask™ Medium Concentration Mask w/ Filtration

• LATEX FREE •

- Effectively combines oxygen delivery with filter media covering exhalation ports
- helps prevent the spread of infectious respiratory expiratory particles
- Helps keep paramedics, hospital staff and visitors safe from infectious pathogens
- Intended for use with patients with respiratory infections and require supplemental oxygen

Item	Description	Qty	\$
4-1145-00	FiltaMask	50	\$81.95



Hope® Nebulizer

High Output, Continuous Medication Nebulizer

• LATEX FREE •

- Refillable, cost effective, high output, continuous medication nebulizer
- Flow design and 200ml reservoir allow for up to 8 hours of nebulized medication delivery at 25ml/hr

Item	Description	Qty	\$
3-1132-00	Hope Nebulizer	25	\$301.95



Neonatal Bubbler

H₂O CPAP for Infants <10 kg

• LATEX FREE •

- Proven method of delivering 0-10 cm H₂O CPAP for infants and neonates <10 kg
- For use with spontaneously breathing patients
- Designed to allow airway pressure to be set without the cumbersome steps normally associated with other bubble CPAP devices
- Closed system minimizes incidence of atmospheric fluid contamination
- Rotating and locking CPAP dial reduces risk of inadvertent setting changes
- Able to view fluid levels without disrupting therapy

Item	Description	Qty	\$
3-0011-02	Neonatal Bubbler	24	\$540.95



NebuTech® Nebulizer

Exceptional Performance, Versatility and Efficiency

• LATEX FREE •

- Delivers front-loaded bolus dosing during critical first 1/3 of each breath
- Provides drug deposition deep into the lungs
- High quality aerosol - 80% of particles in the respirable range (<5 microns)
- Improved patient outcomes translate into financial benefits
- Quick yet effective treatment - 50% shorter treatment times than AeroEclipse II
- 82% of treatments completed in less than 3 minutes
- 45° angle for maximizing patient comfort and treatment compliance
- Patient-friendly accessories provide flexible and improved respiratory treatment
- Filter provides RT protection from exhaled medications
- Spans the full continuum of patient care: pediatrics through elderly



Item	Description	Qty	\$
8992TG-7-50	NebuTech Nebulizer, Aerosol Mask, 7' Tubing, TG Connector, B/V Adapter, Expiratory Filter	50	\$243.95
8990-7-50	NebuTech Nebulizer Mouthpiece, 7' Tubing, B/V Adapter, Expiratory Filter	50	\$299.95
8990TG-7-50	NebuTech Nebulizer, Mouthpiece, 7' Tubing, TG Connector, B/V Adapter, Expiratory Filter	50	\$299.95
8992-7-50	NebuTech Nebulizer, Aerosol Mask, 7' Tubing, B/V Adapter, Expiratory Filter	50	\$243.95

B/V Filter reduces bio fugitive aerosols, providing caregivers with added protection against highly contagious pathogens

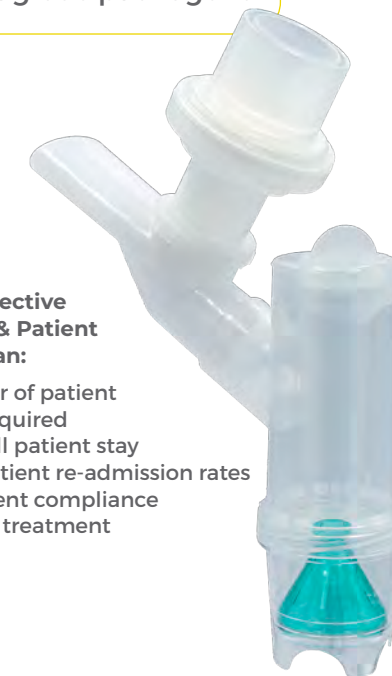

NebuTech's Effective Drug Delivery & Patient Adaptability Can:

- Lower number of patient treatments required
- Reduce overall patient stay
- Help lower patient re-admission rates
- Promote patient compliance with in-home treatment



T-Piece Nebulizer

Reliable, Cost Effective Aerosol Therapy

• LATEX FREE •

- Small volume jet nebulization
- Designed with anti-drool "T" for extended, uncontaminated use
- Ready to use with T-piece, mouthpiece, reservoir tube and supply tubing
- Easy to use; supports patient compliance
- Nebulizes faster than other brands of T-piece devices
- Designed for patient comfort during treatment

Item	Description	Qty	\$
8900-7-50	Nebulizer with T, Mouthpiece, 6" Reservoir Tube, 7' Tubing	50	\$34.95
8900TG-7-50	Nebulizer with T, Mouthpiece, 6" Reservoir Tube, 7' Tubing with Thread Grip	50	\$37.95





Disposable Anesthesia Mask

Color Coded Rings for Easy Size Identification

• LATEX FREE • STERILE • DISPOSABLE •

- Clear construction
- Top valve inflation port
- Compatible with standard catheter mounts and breathing systems

\$2.15 each

Item	Description	Size	Qty	\$
4-5140-00	Anesthesia Mask, Neonate	0	20	\$42.95
4-5140-01	Anesthesia Mask, Infant	1	20	\$42.95
4-5140-02	Anesthesia Mask, Child	2	20	\$42.95
4-5140-03	Anesthesia Mask, Child/Small Adult	3	20	\$42.95
4-5140-04	Anesthesia Mask, Med. Adult	4	20	\$42.95
4-5140-05	Anesthesia Mask, Large Adult	5	20	\$42.95

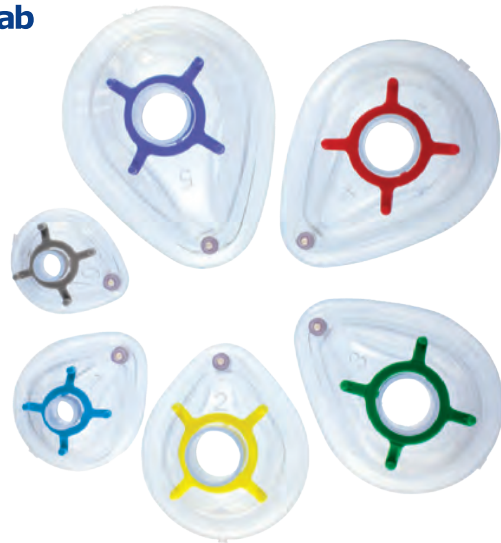

Flexible Anesthesia Mask

Color-Coded Hook Rings

• LATEX FREE • DISPOSABLE •

- Inflatable cuff helps ensure patient comfort
- Reduces wasted anesthetic gas pollution
- Transparent housing for immediate detection of regurgitation or silent aspiration
- Removable color-coded hook rings

\$2.26 each

Item	Description	Size	Qty	\$
4-0110-00	Grey Flexible Mask	Neonate	30	\$67.95
4-0110-01	Light Blue Flexible Mask	Infant	30	\$67.95
4-0110-02	Yellow Flexible Mask	Child	30	\$67.95
4-0110-03	Green Flexible Mask	Small Adult	30	\$67.95
4-0110-04	Red Flexible Mask	Med. Adult	30	\$67.95
4-0110-05	Dark Blue Flexible Mask	Large Adult	30	\$67.95



Traditional Anesthesia Mask

Original Low Pressure Face Mask

• LATEX FREE • DISPOSABLE •

- Soft, pliable, air-filled cushion gently molds to facial anatomy
- Clear material allows early recognition of regurgitation and silent aspiration

as low as \$1.95 each

Item	Description	Qty	\$
4-5210-33	Traditional Mask, Neonate	20	\$38.95
4-5220-34	Traditional Mask, Infant	20	\$38.95
4-5230-35	Traditional Mask with Tail Valve, Toddler	20	\$40.95
4-5240-36	Traditional Mask with Tail Valve, Child	20	\$40.95
4-5245-37	Traditional Mask with Tail Valve, Adult	20	\$38.95



Premium Anesthesia Mask

Inflatable Masks in Seven Sizes

• LATEX FREE • DISPOSABLE •

- Inflatable, soft pliable mask for patient comfort
- Ultra-thin wall, air-filled cushion provides low-pressure soft seal

as low as \$1.40 each

Item	Description	Size	Qty	\$
VR1100	Premium Vent Mask, Small Infant	0	20	\$39.95
VR2100	Premium Vent Mask, Infant	1	20	\$39.95
VR3100	Premium Vent Mask, Small Child	2	20	\$27.95
VR4100	Premium Vent Mask, Child	3	20	\$27.95
VR5100	Premium Vent Mask, Adult	4	20	\$39.95
VR5000	Premium Vent Mask, Wide Adult	5	20	\$39.95
VR6100	Premium Vent Mask, Large Adult	6	20	\$39.95

\$1.63 each



Premium



Premium Plus

\$2.30 each

Premium & Premium Plus Anesthesia Mask

Anatomical Shaped Cushion for Maximum Comfort & Seal

• LATEX FREE • DISPOSABLE •

- Malleable cone and pre-inflated, anatomical shaped cushion
- Use for general anesthesia procedures
- Color coded hook ring
- Made of clear PVC plastic

Item	Description	Size	Qty	\$
4-2250-06	Premium Anesthesia Mask	Neonatal	30	\$48.95
4-2250-07	Premium Anesthesia Mask w/ Green Hook, Toddler	Toddler	30	\$48.95
4-2250-08	Premium Anesthesia Mask w/ Blue Hook & Support Collar	Adult	30	\$48.95
4-2251-01	Premium Plus Anesthesia Mask w/ Green Hook	Toddler	30	\$52.95
4-2251-02	Premium Plus Anesthesia Mask w/ Clear Hook	Child	30	\$52.95
4-2251-03	Premium Plus Anesthesia Mask w/ Yellow Hook	Sm. Adult	30	\$52.95
4-2251-04	Premium Plus Anesthesia Mask w/ Blue Hook & Support Collar	Adult	30	\$68.95



With Valve

\$1.99 each



Without Valve

\$1.94 each

DuraClear™ Face Mask

Fits Every Patient, Every Time

• LATEX FREE • DISPOSABLE • DEHP FREE •

- Superior anatomical design ensures a perfect fit
- Extra soft cuff requires a minimal amount of pressure
- Clear dome allows for easy observation
- Color coded removable hook rings
- Compatible with manual and automatic ventilators and anesthesia machines

Item	Description	Size	Qty	\$
4-2520-81	DuraClear Mask w/ Valve	Neonatal	20	\$39.95
4-2520-82	DuraClear Mask w/ Valve	Infant	20	\$39.95
4-2520-83	DuraClear Mask w/ Valve	Toddler	20	\$39.95
4-2520-84	DuraClear Mask w/ Valve	Sm. Adult	20	\$39.95
4-2520-85	DuraClear Mask w/ Valve	Med. Adult	20	\$39.95
4-2520-86	DuraClear Mask w/ Valve	Lg. Adult	20	\$39.95
4-2520-71	DuraClear Mask	Neonatal	20	\$38.95
4-2520-72	DuraClear Mask	Infant	20	\$38.95
4-2520-73	DuraClear Mask	Toddler	20	\$38.95
4-2520-74	DuraClear Mask	Sm. Adult	20	\$38.95
4-2520-75	DuraClear Mask	Med. Adult	20	\$38.95
4-2520-76	DuraClear Mask	Lg. Adult	20	\$38.95

VBM Medical Inc.



Endoscopy Mask

Allows Ventilation During Endoscopy

• LATEX FREE • DISPOSABLE •

- Suitable for use during intubation, bronchoscopy, gastroenterology and Transesophageal Echocardiography
- Insertion through flexible membrane maintains proper seal for ventilation before, during and after procedure
- Can measure CO₂ by using the right-angle swivel adapter

Item	Description	Size	Qty	\$
4-3040-00	2 mm Endoscopy Mask, Newborn	0	6	\$280.95
4-3040-11	2 mm Endoscopy Mask, Infant	1	6	\$117.95
4-3040-33	3 mm Endoscopy Mask, Child	3	6	\$117.95
4-3040-55	5 mm Endoscopy Mask, Adult	5	6	\$117.95
3-6060-04	Right Angled Swivel Adapter	--	10	\$70.95
4-3040-26	Endoscopy Mask Hook Rings	--	10	\$15.95

DeVilbiss HEALTHCARE



Metal Atomizer

Effectively Spray Inaccessible Areas

• LATEX FREE •

- Adjustable tip for directing spray up or down to reach inaccessible areas of the throat
- Vented nasal guard
- 1 oz capacity bottle

Item	Description	Qty	\$
8-1115-97	Metal Atomizer	1	\$83.95

Teleflex MEDICAL

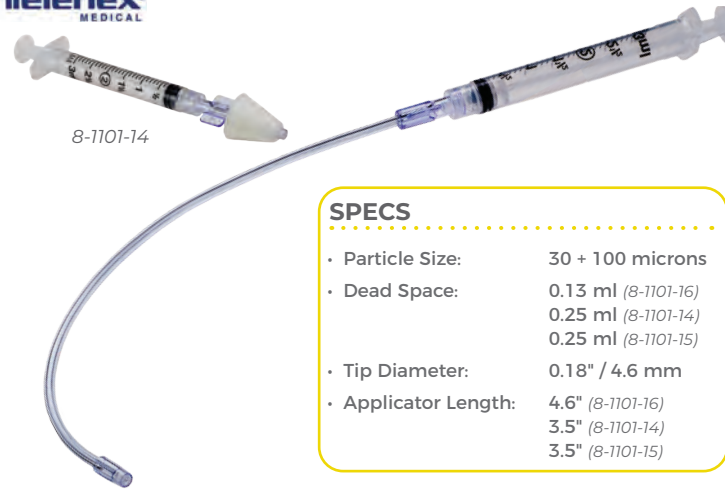

SPECS

- Particle Size: 30 + 100 microns
- Dead Space: 0.13 ml (8-1101-16)
0.25 ml (8-1101-14)
0.25 ml (8-1101-15)
- Tip Diameter: 0.18" / 4.6 mm
- Applicator Length: 4.6" (8-1101-16)
3.5" (8-1101-14)
3.5" (8-1101-15)

Laryngo-Tracheal Mucosal Atomizer

Ideal for Difficult Intubations, Bronchoscopies, Awake Intubations

• LATEX FREE •

- Malleable stylet to attain the precise target delivery to patient's anatomy
- Designed to fit through vocal cords, LMA, or into a nasal cavity
- Exact dosing reduces the risk of toxicity
- Consistent fine atomized spray for direct coverage of mouth and oropharynx

Item	Description	Qty	\$
8-1101-14	Laryngo-Tracheal Mucosal Atomizer w/ 3 ml Syringe	25	\$315.95
8-1101-15	Laryngo-Tracheal Mucosal Atomizer	25	\$293.95
8-1101-16	Pediatric Laryngo-Tracheal Mucosal Atomizer	25	\$279.95

AINCA Anesthesia Associates, Inc.



Patil-Syracuse Oral Airway

Supports Successful Endoscopic Insertion

• LATEX FREE •

- Prevents patient from biting endoscope
- Central groove helps guide endoscope during inseriton
- Slit at end of device allows advancement of endoscope tip beyond epiglottis to visualzie the larynx
- Side challen permits suctioning without interrupting endoscopy

Item	Description	Size	Qty	\$
4-0094-20	Patil-Syracuse Oral Airway	2	1	\$66.95
4-0094-40	Patil-Syracuse Oral Airway	4	1	\$66.95

VBM Medical Inc.



Silicone Mask Head Harness

Autoclavable up to 273°

• LATEX FREE • REUSABLE •

- Molded head harness
- Designed to ensure proper fit
- Individually wrapped

Item	Description	Size	Qty	\$
4-3530-25	Reusable Mask Harness	Adult	10	\$65.95

Trademark Medical



Maskumm™ Anesthesia Mask Spray

Scents Mask for Easier Pediatric Induction

- Eliminates the need for costly manufactured pre-scented masks
- No refrigeration needed
- Environmentally safe; does not use fluorocarbons
- Approximately 300 applications per bottle

Item	Description	Size	Qty	\$
8-0025-04	Bubble Gum Scent Mask Spray	0.6oz	1	\$17.95
8-0025-02	Bubble Gum Scent Mask Spray	0.6oz	10	\$151.95

SunMed



Neoprene Mask Head Harness

Infant, Child & Adult Sizes

• LATEX FREE • DISPOSABLE •

- Molded head harness
- Reinforced rings around each hole for durability
- Designed to ensure proper fit
- Individually wrapped; bulk quantities available

Item	Description	Size	Qty	\$
4-1054-21	Mask Head Harness	Infant	1	\$11.95
4-1054-22	Mask Head Harness	Child	1	\$11.95
4-1054-23	Mask Head Harness	Adult	1	\$11.95
4-1054-21-10	Mask Head Harness	Infant	10	\$89.95
4-1054-22-10	Mask Head Harness	Child	10	\$89.95
4-1054-23-10	Mask Head Harness	Adult	10	\$89.95

SunMed



Blue Mask Head Harness

Webbed Head Portion Permits Ventilation

• LATEX FREE • DISPOSABLE •

- Light blue molded head harness
- Equal distribution of pressure over large area
- Designed to ensure proper fit

Item	Description	Size	Qty	\$
4-1054-01	Blue Mask Head Harness	Adult	1	\$5.95



Fluted Neoprene Breathing Bags

Six Sizes

• LATEX FREE • REUSABLE •

- Resistant to ozone, oxygen, sunlight and heat
- Impervious to body oils and other operating room agents
- Thinner neoprene offers better control and more sensitivity in ascertaining subtle volume changes

Item	Description	Size	Qty	\$
4-1036-05	Fluted Breathing Bag	0.5 L	1	\$19.95
4-1036-10	Fluted Breathing Bag	1.0 L	1	\$21.95
4-1036-20	Fluted Breathing Bag	2.0 L	1	\$21.95
4-1036-30	Fluted Breathing Bag	3.0 L	1	\$20.95
4-1036-40	Fluted Breathing Bag	4.0 L	1	\$24.95
4-1036-50	Fluted Breathing Bag	5.0 L	1	\$28.95



Fluted Neoprene Breathing Bags

Pediatric Sizes

• LATEX FREE •

- 15 mm Female stainless steel bushing
- 5/8" Neck

Item	Description	Size	Qty	\$
4-1039-05	Fluted Breathing Bag	0.5 L	1	\$37.95
4-1039-10	Fluted Breathing Bag	1.0 L	1	\$46.95
4-1039-15	Fluted Breathing Bag	1.5 L	1	\$49.95



Flat Rebreathing Bags

Neoprene, Ohio Type Design

• LATEX FREE • REUSABLE •

- Lightweight rebreathing bag
- Standard 22 mm bushing
- Premium neoprene sensitive to patient respiration

Item	Description	Size	Qty	\$
4-1041-05	Flat Rebreathing Bag	0.5 L	1	\$11.95
4-1041-10	Flat Rebreathing Bag	1.0 L	1	\$12.95
4-1041-15	Flat Rebreathing Bag	1.5 L	1	\$12.95
4-1041-20	Flat Rebreathing Bag	2.0 L	1	\$13.95
4-1041-30	Flat Rebreathing Bag	3.0 L	1	\$13.95
4-1041-40	Flat Rebreathing Bag	4.0 L	1	\$14.95
4-1041-50	Flat Rebreathing Bag	5.0 L	1	\$14.95



Test Lung

Ideal for Ventilator Testing & Demonstration

• LATEX FREE •

- Soft, sensitive neoprene
- Foam filled
- 22 mm bushing

Item	Description	Size	Qty	\$
4-0050-50	Medium Test Lung	500 cc	1	\$19.95
4-0050-10	Large Test Lung	1 L	1	\$21.95

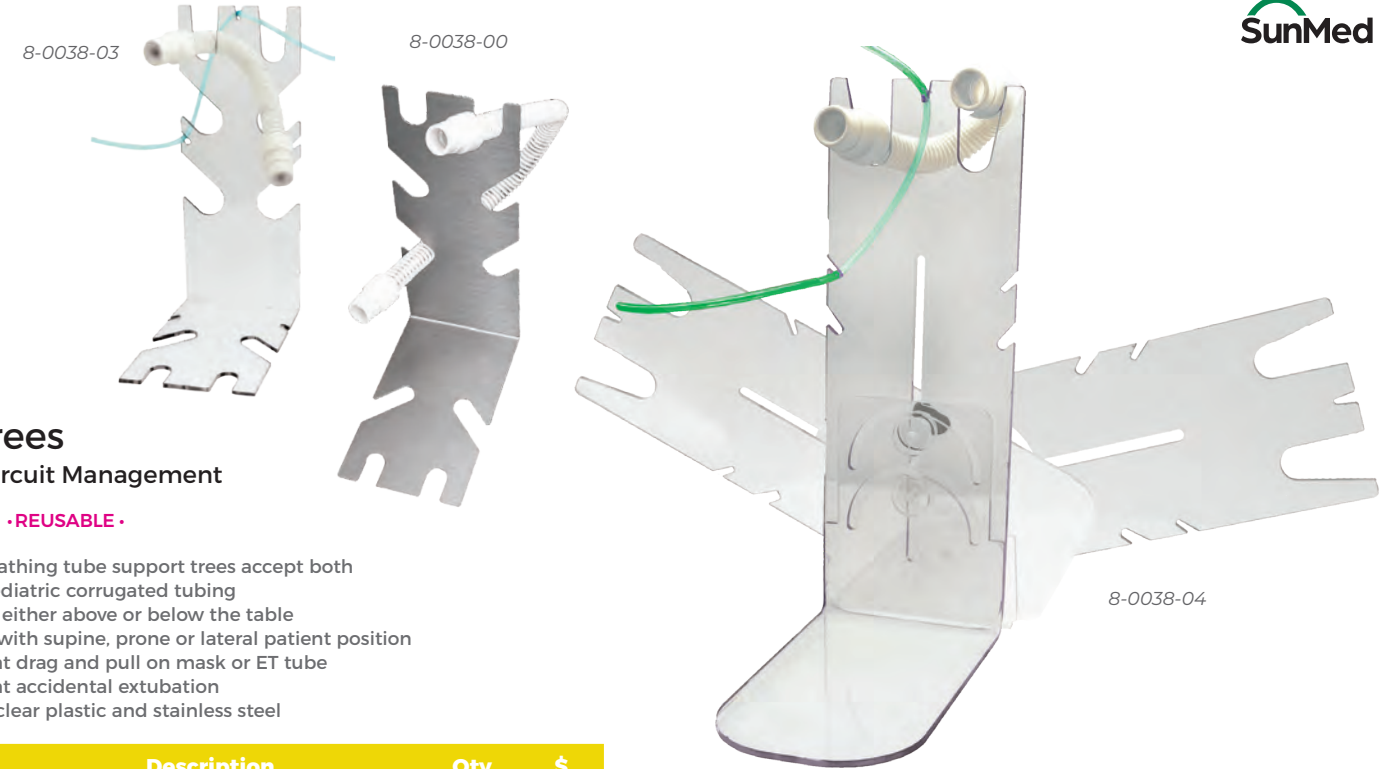

Tube Trees

Effective Circuit Management

• LATEX FREE • REUSABLE •

- Versatile breathing tube support trees accept both adult and pediatric corrugated tubing
- Can be used either above or below the table
- Compatible with supine, prone or lateral patient position
- Helps prevent drag and pull on mask or ET tube
- Helps prevent accidental extubation
- Available in clear plastic and stainless steel

Item	Description	Qty	\$
8-0038-00	Stainless Steel Tube Tree	1	\$23.95
8-0038-03	Clear Plastic Tube Tree	1	\$23.95
8-0038-04	Articulating Universal Clear Plastic Tube Tree	1	\$39.95



Test Lungs

Suitable for Ventilator Training & Verification

- Two individual silicone test lungs with Y connector (15/10 mm port)
- Compliance: approx. 2.0 mL/cm H₂O
- Tidal volume: 25 mL each lung (50 mL total)
- Resistance: 300 cm H₂O/L/s at 1 L/sec
- Lightweight, portable and easy-to-use
- Packaged in zippered bag for storage and transport

Item	Description	Size	Qty	\$
4-0010-11	Venti.Plus Test Lung	0.5 L	5	\$724.95
4-0010-12	Venti.Plus Test Lung	0.5 L	1	\$144.95
4-0010-09	Venti.Plus Test Lung	1.0 L	5	\$574.95
4-0010-10	Venti.Plus Test Lung	1.0 L	1	\$114.95
4-0010-13	Babi.Plus nTest Lung	0.5 L	5	\$999.95
4-0010-14	Babi.Plus nTest Lung	0.5 L	1	\$199.95



Derbyshire Tube Support

Relieves Stress on Patient Mouth & Face

- Sets under table pad under patient's head and shoulders to take the weight of lines off of the mouth and face

Item	Description	Qty	\$
8-3009-00	Derbyshire Tube Support	1	\$57.95



Anesthesia Breathing Circuits

Adult & Pediatric Configurations Available

•LATEX FREE •DISPOSABLE•

Item	Description	Qty	\$
3-3524-05	40" Dual-Limb Corrugated Adult Circuit, Parallel Wye, B/V Filter, Gas Sampling Elbow, 3.0 L Breathing Bag	20	\$143.95
3-3524-07	90" Expandable Dual-Limb Circuit, Fixed Parallel Wye, Connector, B/V Filter, Gas Sampling Elbow, 3.0 L Breathing Bag	20	\$136.95
3-3426-06	30" Dual-Limb Corrugated Pediatric Circuit, Bifurcated Wye, B/V Filter, Gas Sampling Elbow, 1.0 L Breathing Bag	20	\$143.95
3-3426-09	90" Expandable Dual-Limb Circuit, Bifurcated Wye, B/V Filter, Gas Sampling Elbow, 1.0 L Breathing Bag	20	\$144.95



Anesthesia Breathing Bags

Standard 22 mm ID Fitting

•LATEX FREE •DISPOSABLE•

- Lightweight rebreathing bag
- Premium neoprene sensitive to patient respiration

Item	Description	Size	Qty	\$
3-3525-01	Breathing Bag	0.5 L	30	\$83.95
3-3525-02	Breathing Bag	1.0 L	30	\$83.95
3-3525-03	Breathing Bag	2.0 L	30	\$83.95
3-3525-04	Breathing Bag	3.0 L	30	\$83.95



Anesthesia Breathing Circuits

Variety of Configurations Available

•LATEX FREE •DISPOSABLE•

Item	Description	Qty	\$
3-3709-24	40" Corrugated Tubing Fixed Length, Gas Sampling Elbow, Face Mask, Straight "Y", Filter, 3 L Latex Bag	15	\$113.95
3-4509-04	33-87" Expandable Corrugated Tubing, Gas Sampling Elbow, Straight "Y", Filter, 3 L Latex Bag	20	\$100.95
3-4509-56	42-108" Expandable Corrugated Tubing, Gas Sampling Elbow, Face Mask, Straight "Y", 3 L Latex Free Bag	12	\$126.95



Anesthesia Breathing Circuits

Adult & Pediatric Configurations Available

•LATEX FREE •DISPOSABLE•

- Filter option 99.9% B/V efficiency
- Fluted breathing bag ensures no closure regardless of position
- Superior seal reduces leakage
- Humidifier

Item	Description	Size	Qty	\$
5-4503-34	3 L Bag, Gas & Temp Ports, B/V Filter, 40" Hose, Swivel "Y"	Adult	20	\$129.95
5-4502-03	1 L Bag, 32" Hose, Swivel "Y"	Pediatric	20	\$137.95



Corrugated Breathing Circuits

Pediatric & Adult Expandable Tubing Plus Bags

•DISPOSABLE•

- Secure connections are welded together to prevent leakage and maintain connections
- Tubing made of durable yet flexible PVC for excellent drapability
- Secure hand grip enables easy removal from the machine
- Tethered gas sampling ports are attached to prevent loss
- Soft, tactile breathing bag provides excellent feel
- Soft, cushion face mask provides superior seal and patient comfort
- Gas sampling elbow



Available in a variety of lengths and bag volumes along with sampling elbows

Item	Description	Length	Qty	\$
3-8026-00	Pediatric Corrugated Breathing Circuit, 1.0 L Latex Free Breathing Bag, Gas Sampling Elbow, Mini B/V Filter	48"	20	\$91.95
3-8026-10	Pediatric Expandable Breathing Circuit, 1.0 L Latex Free Breathing Bag, Gas Sampling Elbow	72"	20	\$118.95
3-8026-12	Pediatric Expandable Breathing Circuit, 1.0 L Latex Free Breathing Bag, Gas Sampling Elbow, Mini B/V Filter	96"	20	\$121.95
3-8016-47	Adult Corrugated Breathing Circuit, 3.0 L Latex Breathing Bag, Gas Sampling Elbow, B/V Filter	60"	20	\$104.95
3-8016-11	Adult Expandable Breathing Circuit, 3.0 L Latex Free Breathing Bag, Gas Sampling Elbow, B/V Filter	72"	20	\$108.95
3-8016-21	Adult Expandable Breathing Circuit, 3.0 L Latex Free Breathing Bag, Gas Sampling Elbow, B/V Filter	96"	20	\$191.95
3-8018-43	Adult Single Limb Breathing Circuit, 3.0 L Latex Free Breathing Bag, Gas Sampling Elbow, B/V Filter	72"	20	\$255.95



Adult Circuits



Pediatric Circuits

Jackson Rees Non-Rebreathing Circuit

Designed to Resist Occlusion

•LATEX FREE •DISPOSABLE•

- Low profile elbow at the patient interface
- 15mm female connection for use with standard ET tubes, LMAs
- Oxygen tube designed to resist occlusion
- Standard oxygen connector allows for direct fitting to gas source
- Expired gases leave the circuit via a clear corrugated tube, connected to an open-tail reservoir bag



MainlineMedical.com
more great products online



VC1000



VP705

MRI Transport Circuit

Available With or Without PEEP Valve

• LATEX FREE • DISPOSABLE •

- Patient valve, PEEP valve and O2 Tubing constructed of MRI-safe materials
- 3 o'clock position of PEEP keeps valve out of patient's face
- Corrugated tubing expands generously to 9' for easier ventilation management during procedures

Item	Description	Qty	\$
VC1000	MRI Transport Circuit & PEEP Valve	10	\$139.95
VC1000F	MRI Transport Circuit, PEEP Valve & Filter	10	\$160.95
VC1010	MRI Transport Circuit	10	\$99.95
VC1010F	MRI Transport Circuit & Filter	10	\$119.95
VP705	19 mm MRI Conditional Adjustable PEEP Valve	20	\$155.95



Standard Breathing Circuit

Available With Filter Accessory

• LATEX FREE • DISPOSABLE •

- Use as a conduit for gases between a Respironics® positive pressure generator and a patient during non-invasive ventilation
- 72" smooth bore tubing with pressure monitoring line and dual ported adapter
- 24" extension tubing with T-assembly for dual pressure monitoring

Item	Description	Qty	\$
RC1000	Standard Circuit & 22 mm OD Adapter	10	\$199.95
RC1000F	Standard Circuit, 22 mm OD Adapter & Filter	10	\$199.95



Straight Silicone Rubber Connectors

22 mm ID x 22 mm OD

• LATEX FREE • REUSABLE •

- Makes for easy connections
- Silicone rubber remains pliable after sterilization
- Cost effective

Item	Description	Qty	\$
3-1013-10	Straight Silicone Rubber Connector	10	\$55.95
3-1013-50	Straight Silicone Rubber Connector	50	\$253.95

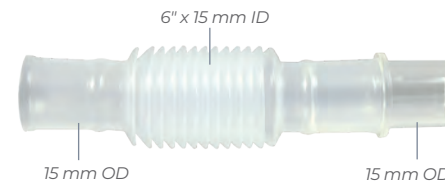

FH106347

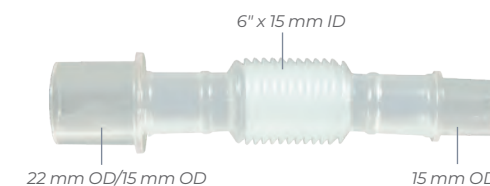

FH106348

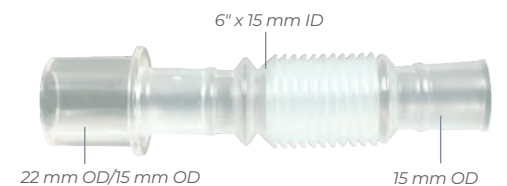

FH106380

Flex Tubing

Filter Accessory

• LATEX FREE • DISPOSABLE •

- For use with hygroscopic condenser humidifiers
- Standard 6" x 15 mm ID flex tubing

Item	Description	Qty	\$
FH106347	15 mm OD x 15 mm OD Flex Tubing	50	\$67.95
FH106348	15 mm OD x 22 mm OD/15 mm ID Flex Tubing	50	\$62.95
FH106380	15 mm OD x 22 mm OD/15 mm ID Flex Tubing with 15 mm OD Connector	50	\$74.95

Flex Connector Tubes

Reusable, Reinforced, Lightweight

• LATEX FREE • REUSABLE •

- Semi-clear
- Flexible spiral, 9/16" smooth I.D. tubing
- Autoclavable

Item	Description	Length	Qty	\$
8-3315-06	5/8" Flex Connector Tube 15 mm Male x 15 mm Female	6"	1	\$21.95
8-3315-10	5/8" Flex Connector Tube 15 mm Male x 15 mm Female	10"	1	\$22.95
8-3315-12	5/8" Flex Connector Tube 15 mm Male x 15 mm Female	12"	1	\$23.95
8-3314-10	5/8" Flex Connector Tube 15 mm Female x 15 mm Female	10"	1	\$22.95



Flexible Breathing Tubing

Available in a Variety of Sizes & Lengths

• LATEX FREE • REUSABLE •

- Pediatric 9/16": 22 mm female x 15 mm female flexible 9/16" smooth ID tubing with molded 22 mm female and 15 mm female ends
- Adult, 9/16": 22 mm female x 22 mm female flexible lightweight semi clear, cream colored polyester, reinforced spiral tubing, 9/16" smooth ID
- Adult, 3/4": 22 mm female x 22 mm female fitting flexible, smooth silicone 3/4" ID tubing with 22 mm female fittings at both ends



Item	Description	Length	Qty	\$
8-3337-30	Pediatric 9/16" Flexible Tubing	30"	1	\$24.95
8-3337-36	Pediatric 9/16" Flexible Tubing	36"	1	\$25.95
8-3321-24	Adult 9/16" Flexible Tubing	24"	1	\$25.95
8-3321-36	Adult 9/16" Flexible Tubing	36"	1	\$27.95
8-3321-48	Adult 9/16" Flexible Tubing	48"	1	\$27.95

Item	Description	Length	Qty	\$
8-3322-08	Adult 3/4" Flexible Tubing	8"	1	\$15.95
8-3322-12	Adult 3/4" Flexible Tubing	12"	1	\$17.95
8-3322-24	Adult 3/4" Flexible Tubing	24"	1	\$19.95
8-3324-36	Adult 3/4" Flexible Tubing	36"	1	\$21.95
8-3322-48	Adult 3/4" Flexible Tubing	48"	1	\$21.95
8-3322-72	Adult 3/4" Flexible Tubing	721"	1	\$28.95

smiths medical



SODASORB® CO₂ Absorbent
World's Leading Brand of CO₂ Absorbent

- Color changes when absorbent capacity is exhausted
- Low dusting – conforms to strict hardness standard
- Three packaging options available

Item	Description	Qty	\$
7-0088-60	Sodasorb 2.5 lb Canister Pak (Refill Bag)	12	\$92.95
7-0088-70	Sodasorb 3 lb Pre-Pak (Canister Discs)	12	\$138.95
7-0088-80	Sodasorb 5 Gallon Pail	1	\$89.95

INTERSURGICAL
COMPLETE RESPIRATORY SYSTEMS



InterSorb CO₂ Absorbent
3% Sodium Hydroxide

- Soda lime carbon dioxide absorbant
- Made of short, 3 mm diameter porous strands

Item	Description	Qty	\$
7-2179-03	InterSorb, Jerican	2	\$41.95

INTERSURGICAL
COMPLETE RESPIRATORY SYSTEMS



LoFloSorb CO₂ Absorbent
Contains No Alkali Hydroxide

- Minimizes the risk associated with reactions with volatile anesthetics
- LoFloSorb contains no Potassium Hydroxide and no Sodium Hydroxide
- Made of 3-4 mm spheres processed to minimize potential dusting
- Features a very stable green to violet color change

Item	Description	Qty	\$
7-2178-02	LoFloSorb, 5 L Jerican	2	\$76.95
7-2188-02	LoFloSorb, 1 kg Drum	10	\$172.95
7-2193-02	LoFloSorb, 1 kg Pyramid	6	\$126.95

INTERSURGICAL
COMPLETE RESPIRATORY SYSTEMS



SpheraSorb CO₂ Absorbent
Uniquely Designed Medical Grade Soda Lime

- Chemical formulation has been developed to provide protection against the potential problems of use within the medical environment, while maintaining the highest possible CO₂ capacity
- Only 1.5% Sodium Hydroxide
- Zeolite to reduce the risk of drying out
- Made of 3-4 mm spheres processed to minimize potential dusting

Item	Description	Qty	\$
7-2173-00	SpheraSorb, 1 kg Bag	10	\$83.95
7-2175-01	SpheraSorb, 5 L Jerican	2	\$58.95
7-2186-01	SpheraSorb, 1 kg Drum	10	\$140.95
7-2191-01	SpheraSorb, 1 kg Pyramid	6	\$108.95
7-2196-01	SpheraSorb, 1 kg IS Canister	6	\$142.95



FLOCAP CO₂ Indicator & EtCO₂ Detector
Reduce Breath Stacking

- LATEX FREE • DISPOSABLE •
- EtCO₂ and flow indication device designed for visualization of exhaled CO₂ and expiratory flow
- Designed to help reduce breath stracking, air trapping and over-distention during resuscitation
- High definition color changing material displays CO₂ percentage
- Foam will not dry out unlike litmus paper used in many indicators
- Florescent orange spinner is easy to see in low light
- For patients > 15 kg (33 lb.)

Item	Description	Qty	\$
R500P21	FLOCAP CO ₂ Indicator & EtCO ₂ Detector	24	\$227.95

JADAMEDICAL



CarboTrack™ CO₂ Airway Adapter
Universal Capnography Safety Adapter

- LATEX FREE • DISPOSABLE •
- Universal CO₂ airway adapter utilized to enhance ET/CO₂ monitoring, designed primarily to adapt to oropharyngeal airways and face masks when administering deep sedation anesthesia
- Captures end-tidal CO₂
- CO₂ port to connect CO₂ sampling
- Nasal cannula docking ports
- Suction/utility port

Item	Description	Qty	\$
1-1500-05	CarboTrack CO ₂ Adapter	10	\$41.95

SunMed

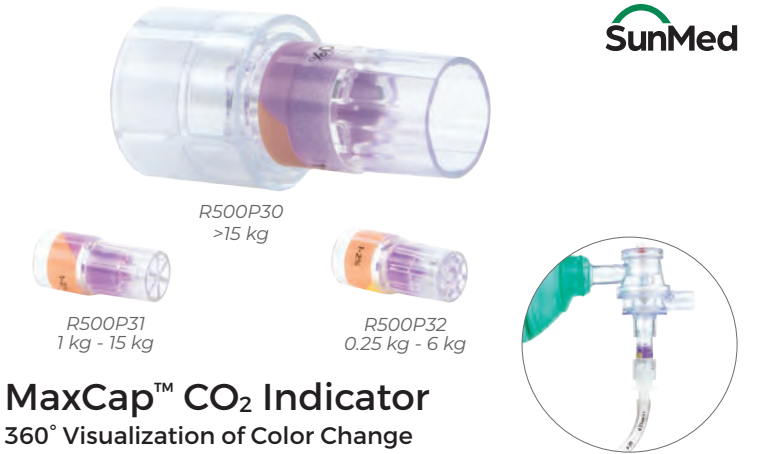

MaxCap™ CO₂ Indicator
360° Visualization of Color Change

- LATEX FREE • DISPOSABLE •
- EtCO₂ and flow indication device designed for quick visualization of exhaled CO₂ and expiratory flow
- 360° visualization of color change which can be seen from any location around patient
- High definition color changing foam material (purple to yellow)
- Foam will not dry out unlike litmus paper used in many indicators
- Weighs less than other CO₂ indicators for less pull on ET tubes

Item	Description	Size	Qty	\$
R500P30	MaxCap CO ₂ Indicator	Regular	10	\$75.95
R500P31	MaxCap CO ₂ Indicator	Pediatric	10	\$100.95
R500P32	MaxCap CO ₂ Indicator	Neonatal	10	\$170.95

Ambu



CO₂ Easy Detector
Verify ET Tube Placement Quickly

- Designed for fast, easy airway assessment
- Verifies proper endotracheal tube placement
- Expansive 2 inch diameter visual indicator makes rapid breath-to-breath response easy to see
- Anti-fogging agent reduces susceptibility to moisture and humidity, while ensuring lens clarity

Item	Description	Qty	\$
8-1727-12	Adult CO ₂ Easy Detector	12	\$127.95
8-1727-13	Pediatric CO ₂ Easy Detector	12	\$127.95



PEEP Valve

Disposable Valve Eliminates Cross Contamination

• **DISPOSABLE** •

- For adults and children
- Fits patient valve of any original Ambu resuscitator
- Quiet and accurate
- Fully adjustable from 1.5 - 20 cm H₂O

Item	Description	Qty	\$
8-5172-22	22 mm PEEP Valve	20	\$92.95
8-5172-30	30 mm PEEP Valve	20	\$92.95



Adjustable PEEP Valve

Designed for Use with Manual Resuscitator/Ventilator

• **LATEX FREE** • **DISPOSABLE** •

- Pressure range: 5-20 cm H₂O
- Large print on scale for improved visibility of setting
- Connects to exhalation port of manual resuscitator

Item	Description	Qty	\$
VP700	19 mm Adjustable PEEP Valve	20	\$89.95
VP702	19 mm Adjustable PEEP Valve, 30 mm Adapter	20	\$89.95
VP703	19 mm Adjustable PEEP Valve, 19 mm Adapter	20	\$89.95
VP705	MRI Conditional Adjustable PEEP Valve	20	\$155.95



8-5172-00

8-5172-04

Adjustable PEEP Valves

The Industry Standard for Accuracy & Reliability

• **LATEX FREE** • **REUSABLE** •

- Lightweight and durable
- Features a virtually unbreakable polysulphone housing and stainless steel spring
- 30 mm connector and fully adjustable 0-20 cm H₂O
- May be repeatedly autoclaved at 134° C

Item	Description	Qty	\$
8-5172-00	30 mm x 0-20 cm H ₂ O	1	\$144.95
8-5172-04	22 mm x 0-20 cm H ₂ O	1	\$144.95
8-5171-02	18 mm x 0-10 cm H ₂ O	1	\$120.95
8-5171-03	30 mm x 0-10 cm H ₂ O	1	\$120.95
8-5171-00	18 mm / 30 mm x 0-10 cm H ₂ O	1	\$138.95



ACCU-PEEP

Minimal Deviation in Expiratory Pressure at All Flows

• **LATEX FREE** • **DISPOSABLE** •

- Provides consistent levels of PEEP irrespective of flow
- Resistance levels maintained regardless of flow in both CPAP and anesthesia/ventilation applications
- Allows for exhalation if valve is incorrectly positioned

Item	Description	Qty	\$
8-9003-23	2.5 cm H ₂ O ACCU-PEEP	10	\$108.95
8-9005-50	5.0 cm H ₂ O ACCU-PEEP	10	\$108.95
8-9012-12	12.5 cm H ₂ O ACCU-PEEP	10	\$108.95
8-9015-15	15.0 cm H ₂ O ACCU-PEEP	10	\$108.95
8-9018-10	10.0 cm H ₂ O ACCU-PEEP	10	\$108.95
8-9020-20	20.0 cm H ₂ O ACCU-PEEP	10	\$108.95



VentiShield Bacterial Filter

Compact, Lightweight Design Provides 99.999% Efficiency

• **LATEX FREE** • **STERILE** • **DISPOSABLE** •

- Recommended for applications where high efficiency and low pressure drop is required
- Offers excellent efficiency for anesthetic breathing and pulmonary filters
- Universal 22 mm male / 15 mm female connectors
- Compatible with all brands of circuits

Item	Description	Qty	\$
8-3841-60	Adult VentiShield B/V Filter, No Port	50	\$53.95
8-3841-65	Adult VentiShield B/V Filter, Luer Lock & Port	50	\$77.95
8-3842-60	Mini VentiShield B/V Filter	50	\$53.95
8-3842-65	Mini VentiShield B/V Filter, Luer Lock & Port	50	\$77.95

Bacterial / Viral Filter

Available in a Variety of Sizes & Shapes

• **LATEX FREE** • **DISPOSABLE** •

- Help reduce the transmission of microbes and other particulate matter in the breathing system
- Filters up to 99.99% of expiratory bacterial/viral content
- Designed to reduce drag on the breathing system while ensuring patient comfort
- Compatible with leading breathing systems
- Individually packaged 50 EA/CS

BACTERIAL / VIRAL FILTER				
ITEM	BF102	BF103	FH603003	FH603026
DESCRIPTION	Accepts 19 mm or 30 mm	Accepts 19 mm or 30 mm	Vt Range >250 mL	Tidal Volume >150 mL
B/V EFFICIENCY	>99.99%	>99.99%	>99.99%	>99.99%
WEIGHT (g)	11.8	12.4	25.0/25.7	40.6
ID / OD (mm)	19 ID x 22 ID / 30 OD	30 ID x 22 ID / 30 OD	22 ID x 15 ID / 22 OD	22 ID x 15 ID / 22 OD
DEAD SPACE (mL)	20	29	34	52
RESISTANCE (cm H ₂ O) 30 LPM	<2.2	<2	<1 (<2 @60 LPM)	<1.55
SAMPLING PORT	No	No	No	No
\$ PER CS OF 50	\$64.95	\$64.95	\$54.95	\$169.95



HEPA Filter

Effectively Filters for COVID-19

• **LATEX FREE** • **DISPOSABLE** •

- Bacterial/viral filtration
- Sampling port
- 99.9999% Filtration efficacy
- 22 mm OD/15 mm ID x 22 mm ID/15 mm OD
- 62 mL Deadspace
- 250 mL - 1500 mL Tidal volume

Item	Description	Qty	\$
FH603074	HEPA Filter	50	\$169.95

smiths medical



Thermovent® 600 / 1200 HME
Passive Humidification

• LATEX FREE • DISPOSABLE •

- Can be used in anesthesia or ICU and for patients with adult tidal volume
- Low resistance to flow
- Small dead space
- Full compatibility with breathing systems for masks

Item	Description	Qty	\$
1-5800-20	Thermovent® 1200 HME	50	\$71.95
1-5800-10	Thermovent® 600 HME	50	\$134.95

smiths medical



Thermovent® HME/HEPA
Provides Excellent Heat, Filtration & Passive Humidification

• LATEX FREE • DISPOSABLE •

- Outstanding filtration capabilities and highly hydrophobic (up to 150 cm H₂O)
- For use with mechanical ventilators, anesthesia machines and open flow systems
- Provide B/V efficiency ratings up to 99.999%
- ISO Standard tapered ends assure a consistent leak-free seal
- Hydrophobic membrane

Item	Description	Qty	\$
1-0028-95	Thermovent® HME/HEPA	50	\$202.95

smiths medical



Thermovent® T 1000 HME
Suitable for Tracheostomy Patients

• LATEX FREE • DISPOSABLE •

- Recommended for spontaneously breathing patients with a tracheostomy
- 25 mg H₂O/L at 34 degrees C for 1000 mL tidal volume
- 2.0 cm H₂O at 60 L/min
- Corrugated paper media
- 5 g weight

Item	Description	Qty	\$
1-5700-15	Thermovent® T 1000 HME	50	\$133.95
1-5700-10	Supplement O2 Delivery Adapter for Thermovent® T	10	\$58.95

smiths medical



HME Straight w/ Gas Port
Efficient Heat & Moisture Recovery

• LATEX FREE • DISPOSABLE •

- Exhibits low resistance to flow and high moisture output helping to minimize the loss of heat and moisture in ventilated or spontaneously breathing patients
- ISO standard tapered ends assure consistent leak-free seal
- Available with flex tube for easier connection to endotracheal tube

Item	Description	Qty	\$
1-0028-13	90-1500 mL HME w/ Gas Port, Straight	50	\$97.95
1-0028-37	6.5" Flex Tube (15 mm ID x 22 mm ID)	50	\$95.95

ventlab

Heat Moisture Exchangers

Available With and Without Filtration Media

• LATEX FREE • DISPOSABLE •

- Help reduce the transmission of microbes and other particulate matter in the breathing system
- Media filters up to 99.99% of expiratory bacterial/viral content
- Designed to reduce drag on the breathing system while ensuring patient comfort
- Compatible with leading breathing systems
- Individually packaged 50 EA/CS

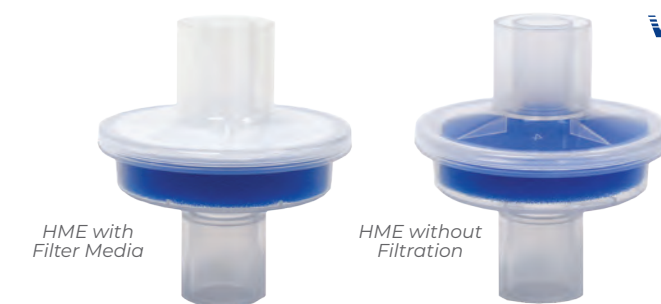

HEAT MOISTURE EXCHANGER + FILTRATION MEDIA (HMEF)						
ITEM	FH603008 / FH603005 Port / No Port	FH603009	FH603011	FH603013	FH603020 / FH603022 Port / No Port	FH603027
DESCRIPTION	Round, Large	Swivel	Rectangular	Angled, Small	Straight, Small	Straight, Pediatric
VT RANGE (mL)	150 - 1500	250 - 1500	200 - 1500	150 - 1500	150 - 1500	150 - 1500
MOISTURE OUTPUT (mg H ₂ O/L) ±0.1g	34.1	36	32.5	33.4	33.6	34.0
WEIGHT (g)	18.5	38.3	37.2	17.2	15.0	13.6
ID / OD (mm)	22 ID x 22 OD / 15 ID	15 ID x 22 OD / 15 ID	22 ID x 22 OD / 15 ID	22 ID x 22 OD / 15 ID	22 ID x 22 OD / 15 ID	22 ID x 22 OD / 15 ID
DEAD SPACE (mL)	47	74	62	42.8	35.5	24.3
RESISTANCE (cm H ₂ O) 30 lpm	0.8	<2	<1	1.9	2	2.4
B/V EFFICIENCY	>99.99%	>99.99%	>99.99%	>99.99%	>99.99%	>99.99%
\$ PER CS OF 50	\$75.95 / \$99.95	\$99.95	\$75.95	\$76.95	\$75.95 / \$75.95	\$53.95

HEAT MOISTURE EXCHANGER (HME)						
ITEM	FH603007 / FH603006 Port / No Port	FH603010	FH603012	FH603014	FH603021 / FH603023 Port / No Port	FH603028
DESCRIPTION	Round, Large	Swivel	Rectangular	Angled, Small	Straight, Small	Straight, Pediatric
VT RANGE (mL)	150 - 1500	250 - 1500	200 - 1500	150 - 1500	150 - 1500	150 - 1500
MOISTURE OUTPUT (mg H ₂ O/L) ±0.1g	33.4	34	32	33.2	33.7	34.0
WEIGHT (g)	17.8	37.1	36.4	16.8	14.7	13.6
ID / OD (mm)	22 ID x 22 OD / 15 ID	22 ID x 22 OD / 15 ID	15 ID x 22 OD / 15 ID	22 ID x 22 OD / 15 ID	22 ID x 22 OD / 15 ID	22 ID x 22 OD / 15 ID
DEAD SPACE (mL)	47	74	62	42.8	35.3	24.3
RESISTANCE (cm H ₂ O) 30 lpm	0.2	<1	<1	0.5	0.6	0.4
\$ PER CS OF 50	\$74.95 / \$74.95	\$99.95	\$74.95	\$74.95	\$74.95 / \$74.95	\$53.95



Jet Ventilator & Accessories

MRI Safe Version Available

• LATEX FREE • REUSABLE •

- Ventilation system for rigid wall bronchoscopy and laryngeal microsurgery
- 5' long pressure tubing
- Features O₂ DISS fitting, flow control valve, thumb control valve, pressure gauge
- 20" clear plastic tubing with luer fitting for adapter attachments
- Features luer connection at the proximal end for attachment to jet ventilator and a round distal end
- The soft malleable tube can be used in laser surgery

Jet Ventilators

Item	Description	Qty	\$
9-0032-50	Jet Ventilator with 5' Hose	1	\$420.95
9-8000-48	MRI Jet Ventilator with 5' Hose	1	\$999.95

Hoses & Copper Stylets

Item	Description	Size	Qty	\$
8-1400-03	High Pressure Hose	3' L	1	\$57.95
8-1400-05	High Pressure Hose	5' L	1	\$62.95
8-1400-08	High Pressure Hose	8' L	1	\$79.95
8-1400-10	High Pressure Hose	10' L	1	\$94.95
9-0032-90	Adult Copper Stylet	20 cm	1	\$33.95
9-0032-91	Child Copper Stylet	15 cm	1	\$33.95
9-0032-92	Infant Copper Stylet	10 cm	1	\$33.95

VBM Medical Inc.



Manual Suction Pump

Complete Set: Canister, Suction Tips, Catheter Adapter

- Provides consistent levels of PEEP irrespective of flow
- Resistance levels maintained regardless of flow in both CPAP and anesthesia/ventilation applications
- Allows for exhalation if valve is incorrectly positioned

Item	Description	Qty	\$
8-3055-50	Manual Suction Pump Set	1	\$83.95
8-3056-05	Child Canister, 50 mL	10	\$56.95
8-3056-25	Adult Canister, 250 mL	10	\$56.95

MainlineMedical.com
more great products online

VBM Medical Inc.

ManuJet III & Jet Vent Catheters

Ready for Immediate Use

• LATEX FREE • REUSABLE •

- Guarantees a quick and efficient oxygenation of patient
- Combined with jet ventilation catheters, ManuJet III is ideal for ER, cras carts, ambulance and OR
- Simple mechanical system is lightweight, portable and ready to use
- Connector not included
- Jet vent catheters allow safe and atraumatic transtracheal access for oxygenation/ventilation with ManuJet III (compatible with automatic high frequency jet ventilator)
- Standard and single lumen catheters available

ManuJet III Kit

Item	Description	Qty	\$
9-3001-03	ManuJet III Jet Ventilator Kit	1	\$560.95

Jet Vent Catheters

Item	Description	Qty	\$
1-3002-93	Jet Vent Catheter w/ Syringe, 13G-Adult	1	\$51.95
1-3002-94	Jet Vent Catheter w/ Syringe, 14G-Child	1	\$51.95
1-3002-98	Jet Vent Catheter w/ Syringe, 16G-Infant	1	\$51.95
1-3012-93	Jet Vent Catheter, 13G-Adult	5	\$247.95
1-3012-94	Jet Vent Catheter 14G-Child	5	\$247.95
1-3012-98	Jet Vent Catheter, 16G-Infant	5	\$247.95



Instrumentation Industries, Inc.



Transtracheal Catheter

For Use with Jet Ventilators

• LATEX FREE • STERILE • DISPOSABLE •

- 15 mm O.D. and Luer lock connection
- Foam necktape with Velcro lock

Item	Description	Size	Qty	\$
1-1060-01	Adult Transtracheal Catheter	13G	1	\$103.95
1-1060-02	Child Transtracheal Catheter	14G	1	\$103.95

Instrumentation Industries, Inc.



Manual Jet Ventilator

Effectively Use with Needle Cricothyroidotomy

• LATEX FREE • REUSABLE •

- Can be used in conjunction with needle cricothyroidotomy to ventilate patients
- On/Off spring valve provides flow when pressed - stops flow when released

Item	Description	Qty	\$
9-1830-01	Jet Ventilator w/ Regulator, 6' High Pressure Hose, 4' Small Bore Tubing	1	\$378.95
9-0004-05	Replacement Regulator	1	\$186.95
9-0004-14	4' Small Bore Tubing	1	\$21.95
9-0004-16	6' High Pressure Hose	1	\$39.95



Compact Click-Style Oxygen Regulator

Pediatric, Hospital & Emergency Applications

- LATEX FREE •
- Extended aluminum body with brass inlet chamber
- Tested to CGA standards which include ignition testing
- Dial-in flow control
- Maximum inlet pressure 3000 psi
- Sintered filter for additional safety and to extend regulator life
- Internal reseating relief valve protects against over pressurization
- 1-1/2" diameter gauge
- Hose barb outlet or DISS 1240 outlet for use with a humidifier bottle
- 2-year limited warranty

Item	Description	Delivery Pressure	Connection Inlet	Connection Outlet	Qty	\$
8-0810-01	Compact Style, 1/64, 1/32, 1/16, 1/8, 1/4, 1/2, 3/4, 1, 1 1/2, 2 LPM, (0-2 LPM)	15 psi	Yoke	Hose Barb	1	\$59.95
8-0820-02	Compact Style, 1/4, 1/2, 2, 3, 4, 6, 8, 10, 15L PM, (0-15 LPM)	50 psi	Yoke	Hose Barb	1	\$39.95
8-0840-04	Compact Style, 1/2, 1, 1 1/2, 2, 2 1/2, 3, 4, 5, 6, 8 LPM, (0-8 LPM)	50 psi	Yoke	Hose Barb	1	\$42.95
8-0821-01	Extended Style, 1/4, 1/2, 1, 2, 3, 4, 6, 8, 10, 15 LPM, (0-15 LPM)	50 psi	Yoke	DISS	1	\$40.95



Tru-Flow™ Oxygen Flowmeters

Take-Off & Double Unit Configurations Available



- LATEX FREE • REUSABLE •
- Oxygen LPM: 0-15
- Lexan inner calibrated flow tube has a lifetime warranty on calibration and manufacturing defects
- 50 psi auxiliary power take-off and double unit configurations available
- Fine-threaded needle valve provide precise gas flow control

Item	Description	Qty	\$
8-8151-01	Adapter Free Inlet, 1/8" NPT Female Inlet	1	\$24.95
8-8151-04	Hand Nut Inlet, with Adapter	1	\$41.95
8-8151-07	Ohmeda Inlet, Standard, with Adapter	1	\$39.95
8-8153-07	Ohmeda Inlet, Take Off	1	\$59.95
8-8154-07	Ohmeda Inlet, Double	1	\$99.95
8-8151-09	Chemetron Inlet, with Adapter	1	\$39.95
8-8153-09	Chemetron Inlet, Take Off	1	\$59.95
8-8154-09	Chemetron Inlet, Double	1	\$99.95
7-9900-05	Large Cylinder Wrench	1	\$9.95
7-9900-03	Small Steel/Zinc Cylinder Wrench	1	\$6.95



Ohmeda Quick Connect Stem Medical Gas Fittings

- LATEX FREE • REUSABLE •
- Green, yellow, and white color coding for oxygen, air and vacuum
- Available in 7 connections to fit a variety of devices

*Indicates item pictured



Hand Nut

Item	Description	\$/Ea
8-1321-08*	Oxy x Hand Nut	\$23.95
8-1322-08	Air x Hand Nut	\$27.95
8-1323-08	Vac x Hand Nut	\$27.95
8-1324-08	N20 x Hand Nut	\$26.95



NPT Male

Item	Description	\$/Ea
8-1321-03	Oxy x 1/4"	\$17.95
8-1322-03*	Air x 1/4"	\$25.95
8-1323-03	Vac x 1/4"	\$17.95
8-1324-03	N20 x 1/4"	\$17.95



NPT Female

Item	Description	\$/Ea
8-1321-02	Oxy x 1/8"	\$15.95
8-1322-02	Air x 1/8"	\$15.95
8-1323-02*	Vac x 1/8"	\$15.95
8-1324-02	N20 x 1/8"	\$16.95



NPT Male

Item	Description	\$/Ea
8-1321-01*	Oxy x 1/8"	\$16.95
8-1322-01	Air x 1/8"	\$15.95
8-1323-01	Vac x 1/8"	\$15.95
8-1324-01	N20 x 1/8"	\$16.95



Hex Nut

Item	Description	\$/Ea
8-1321-06	Oxy x Hex Nut	\$19.95
8-1322-06	Air x Hex Nut	\$25.95
8-1323-06*	Vac x Hex Nut	\$25.95
8-1324-06	N20 x Hex Nut	\$24.95



DISS Male

Item	Description	\$/Ea
8-1321-05	Oxy x DISS	\$25.95
8-1322-05*	Air x DISS	\$25.95
8-1323-05	Vac x DISS	\$25.95
8-1324-05	N20 x DISS	\$23.95



Hose Barb

Item	Description	\$/Ea
8-1321-11	Oxy x 1/4"	\$17.95
8-1322-11*	Air x 1/4"	\$17.95
8-1323-11	Vac x 1/4"	\$17.95
8-1324-11	N20 x 1/4"	\$19.95

Chemetron Quick Connect Stem Medical Gas Fittings

- LATEX FREE • REUSABLE •
- Green, yellow, and white color coding for oxygen, air and vacuum
- Available in 7 connections to fit a variety of devices

*Indicates item pictured



Hand Nut Female

Item	Description	\$/Ea
8-1331-08	Oxy x Hand Nut	\$22.95
8-1332-08	Air x Hand Nut	\$25.95
8-1333-08*	Vac x Hand Nut	\$25.95
8-1334-08	N20 x Hand Nut	\$25.95



NPT Male

Item	Description	\$/Ea
8-1331-03	Oxy x 1/4"	\$20.95
8-1332-03	Air x 1/4"	\$17.95
8-1333-03*	Vac x 1/4"	\$17.95
8-1334-03	N20 x 1/4"	\$17.95



NPT Female

Item	Description	\$/Ea
8-1331-02	Oxy x 1/8"	\$15.95
8-1332-02*	Air x 1/8"	\$16.95
8-1333-02	Vac x 1/8"	\$15.95
8-1334-02	N20 x 1/8"	\$16.95



NPT Male

Item	Description	\$/Ea
8-1331-01*	Oxy x 1/8"	\$15.95
8-1332-01	Air x 1/8"	\$15.95
8-1333-01	Vac x 1/8"	\$16.95
8-1334-01	N20 x 1/8"	\$16.95

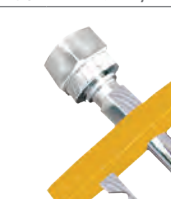

Hex Nut Female

Item	Description	\$/Ea
8-1331-06	Oxy x Hex Nut	\$18.95
8-1332-06*	Air x Hex Nut	\$23.95
8-1333-06	Vac x Hex Nut	\$23.95
8-1334-06	N20 x Hex Nut	\$23.95



DISS Male

Item	Description	\$/Ea
8-1331-05*	Oxy x DISS	\$20.95
8-1332-05	Air x DISS	\$22.95
8-1333-05	Vac x DISS	\$22.95
8-1334-05	N20 x DISS	\$22.95



Hose Barb

Item	Description	\$/Ea
8-1331-11*	Oxy x 1/4"	\$16.95
8-1332-11	Air x 1/4"	\$18.95
8-1333-11	Vac x 1/4"	\$18.95
8-1334-11	N20 x 1/4"	\$18.95



8-5500-08



8-5106-05

Chrome Plated Cylinder Carts/Racks

Available in Various Styles & Sizes

- Sizes: D, E, H, K or M Tank - single through 20 racks available
- Retractable trailing axle
- Equipped with predrilled feet for securing racks to the floor
- Reinforced double bar shelf frames
- Chrome powder coat

Item	Description	Qty	\$
8-5000-12	D or E 6-Slot Cylinder Rack	1	\$82.95
8-5000-13	D or E 12-Slot Cylinder Rack	1	\$186.95
8-5000-14	D or E 20-Slot Cylinder Rack	1	\$87.95
8-5106-05	E 6-Slot Cylinder Cart	1	\$140.95
8-5400-07	H, K, M Single Cylinder Cart	1	\$195.95
8-5500-08	H Dual Cylinder Cart	1	\$270.95

Cylinder Carts with Adjustable Handles

6" Durable Wheels

- 2-1/2 diameter chrome plated case
- 1/4" NPT Male black connection
- Front zero correcting screw
- Threaded tubing adapter for use with 1.4" FPT x 1/4" OD manometer tubing



8-5000-11

Item	Description	Qty	\$
8-5000-02	D or E 4-Slot Cylinder Cart	1	\$82.95
8-5000-06	D or E 12-Slot Cylinder Cart	1	\$186.95
8-5000-07	D or E 6-Slot Cylinder Cart	1	\$87.95
8-5000-11	D or E Dual Cylinder Cart	1	\$91.95
8-5001-89	D or E Single Cylinder Cart	1	\$76.95

Christmas Tree Connectors

One- and Two-Piece Connector Available

• LATEX FREE • DISPOSABLE •

- USA green oxygen color indicator
- One-piece connector has no loose parts
- Two-piece connector may be rotated while tubing is attached

Item	Description	Color	Qty	\$
8-2311-20	One-Piece Christmas Tree Connector	Green	50	\$18.95
8-2311-50	Two-Piece Christmas Tree Connector	Green	50	\$23.95
8-2752-50	Two-Piece Christmas Tree Connector	Yellow	50	\$31.95
8-2753-50	Two-Piece Christmas Tree Connector	White	50	\$33.95



Oxygen Regulator

Smallest Gauge Regulator

- Compact and lightweight: 4.25" long, 11.5 oz
- Contents gauge on the front, flow gauge on the top
- Flow adjustment knob is easily accessible
- Large easy-to-read numbers on the flow gauge provide better visibility of the flow setting
- Unique uni-body design makes it a great alternative for those who prefer a gauge-type regulator over a dial regulator
- Safe to use with built-in pressure relief valve and protected contents gauge
- Low-force rubber yoke seal provides an effective tank-to-reg seal
- Accurate readings
- Yoke or nut style options in three flow rates: 1-5 lpm, 1-8 lpm and 2-15 lpm

Item	Description	Qty	\$
8-8000-01	O ₂ Regulator, Yoke Styler, 0-15 lpm	1	\$74.95
8-8000-04	O ₂ Regulator, Nut Style, 0-8 lpm	1	\$80.95
8-8000-02	O ₂ Regulator, YokeStyle, 0-8 lpm	1	\$72.95
8-8000-03	O ₂ Regulator, Nut Style, 0-15 lpm	1	\$73.95



Oxygen Flow Valve

Instant Oxygen Delivery

- Provides immediate oxygen flow when resuscitator bag is lifted from lever
- Adult, pediatric/neonatal flowmeter mount
- For bags > 3 oz (90g)
- On/off action is controlled by lifting/replacing resuscitator bag on lever
- Excellent for all ICU environments, ED, trauma units
- Forked lever arm does not require bag hanger
- Constructed of sturdy anodized aluminum

Item	Description	Qty	\$
3-3000-00	O ₂ Flow Valve	1	\$192.95



3-Way Stopcocks

Three Options to Choose From

- 9-5311-01: Small bore, non-DEHP formulation, lipid resistant, non-PVC, 45 PSI rated
- 9-4311-01: Large bore, non-DEHP formulation, lipid resistant, non-PVC, 45 PSI rated
- 9-4331-01: Latex free, sterile, single use, 700 PSI rated

Item	Description	Qty	\$
9-5311-01	3-Way Stopcock w/ Swivel Male Luer Lock	50	\$38.95
9-4311-01	3-Way Stopcock w/ Extended Male Luer Lock	50	\$52.95
9-4331-01	3-Way Stopcock w/ Luer Lock "Off" Handle	25	\$52.95



9-5311-01



9-4311-01

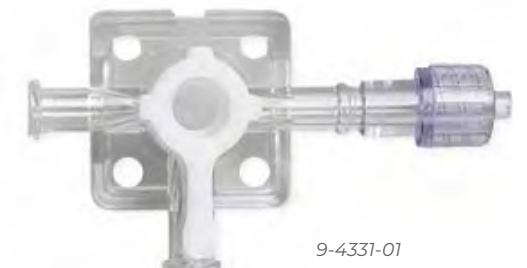

9-4331-01





Tracheal Tube Connectors
For ET Tubes

• LATEX FREE • REUSABLE •



Straight

Item	Description	\$/Ea
3-3100-40	4 mm x 15 mm (M)	\$11.95
3-3100-50	5 mm x 15 mm (M)	\$11.95
3-3100-60	6 mm x 15 mm (M)	\$11.95
3-3100-70	7 mm x 15 mm (M)	\$11.95
3-3100-80	8 mm x 15 mm (M)	\$11.95
3-3100-90	9 mm x 15 mm (M)	\$11.95



Acute 60° No Port

Item	Description	\$/Ea
3-3101-30	3 mm x 15 mm (M)	\$26.95
3-3101-40	4 mm x 15 mm (M)	\$20.95
3-3101-50	5 mm x 15 mm (M)	\$20.95
3-3101-60	6 mm x 15 mm (M)	\$20.95
3-3101-70	7 mm x 15 mm (M)	\$20.95
3-3101-80	8 mm x 15 mm (M)	\$20.95
3-3101-90	9 mm x 15 mm (M)	\$20.95



90° No Port

Item	Description	\$/Ea
3-3120-40	4 mm x 15 mm (M)	\$17.95
3-3120-50	5 mm x 15 mm (M)	\$17.95
3-3120-60	6 mm x 15 mm (M)	\$17.95
3-3120-70	7 mm x 15 mm (M)	\$17.95
3-3120-80	8 mm x 15 mm (M)	\$17.95
3-3120-90	9 mm x 15 mm (M)	\$17.95



T-Adapter (TIB)

Item	Description	\$/Ea
3-0196-00	22 mm (F) x 15 mm (M)	\$35.95



Elbow

Item	Description	\$/Ea
3-0169-00	22 mm OD x 15 mm ID (M)	\$33.95



Corrugated Connector

Item	Description	\$/Ea
3-0183-22	22 mm (M) x 22 mm (M)	\$17.95



Washington T-Tube

Item	Description	\$/Ea
3-0201-15	15 mm (F) x 15 mm (M)	\$23.95



Universal Female Adapter

Aluminum

• LATEX FREE •

- 22 mm female to 15 mm
- weights 9 g
- Adapts "Y" pieces and other 22 mm male fittings to 15 mm tracheal tube connectors

Item	Description	\$/Ea
3-0180-00	Universal Female Adapter	\$24.95



Mask Elbow w/ Pop-Off Valve

Use for Patient Transport from OR to ICU

• LATEX FREE •

- Machine end is 22 mm male, patient end is 22 mm male and 15 mm female
- Acrylic
- Ventilator circuit product

Item	Description	\$/Ea
3-0223-01	Large Mask Elbow	\$93.95



Mask Elbow Connector

Aluminum & Stainless Steel

• LATEX FREE •

- Combination 22 mm male and 15 mm female fittings for both mask and tracheal tube connectors
- Machine end is 15 mm

Item	Description	\$/Ea
3-0168-03	Aluminum Mask Elbow	\$31.95
3-0168-55	Stainless Steel Mask Elbow	\$37.95



Rovenstine Angle Connector

Chrome Plated Brass

• LATEX FREE •

- 90° Angle

Item	Description	\$/Ea
3-0202-15	Rovenstine Connector	\$36.95



Teflon Flex Connector

Reusable Lightweight Teflon Connector

- 15 mm male and female threaded ends
- Translucent
- Can be heat sterilized
- Non-conductive

Item	Description	Size	Qty	\$
3-3146-55	Teflon Flex Connector	15 mm	1	\$61.95



Flexible Metal Adapter

15 mm Female x 15 mm Male Fittings

• LATEX FREE • REUSABLE •

- Permits positioning of tracheal tube Y-piece and tracheal tube connectors at any convenient angle
- Low 15 mL dead space
- Chrome plated brass

Item	Description	Qty	\$
3-0186-15	4.75" Flexible Metal Adapter	1	\$44.95



Racine Universal Connector

Provides a Firm, Tight Seal

• LATEX FREE • REUSABLE •

- Allows movement of breathing circuit at patient end
- Eliminates the need for connectors of varying types and sizes
- Patented diaphragm allows quick and easy tube insertion which provides a firm, tight seal
- Aluminum and silicone construction
- Fits 7 mm to 10.5 mm tubes

Item	Description	Qty	\$
3-3013-03	4" Racine Universal Connector	1	\$24.95



Synthetic Rubber Connectors

Delrin Fitting Autoclavable Connectors

• LATEX FREE • REUSABLE •

- 15 mm (M) x 15 mm (F)
- Steam autoclavable
- Delrin fitting on both ends
- Lightweight

Item	Description	Size	Qty	\$
3-0046-03	Synthetic Rubber Connector	3"	1	\$6.95
3-0046-06	Synthetic Rubber Connector	6"	1	\$9.95
3-0046-09	Synthetic Rubber Connector	9"	1	\$12.95
3-0046-13	Synthetic Rubber Connector	13"	1	\$16.95



This product has been manufactured with materials that do not contain BPA

BreatheRite™ Medication Delivery Anti-Static Valved Holding Chamber

• LATEX FREE •

- Anti-static chamber enables effective medication delivery
- Designed to promote greater drug volume output
- Inspiratory aperture ensures proper inspiratory rate, important for complete delivery deposition
- Chamber design eliminates the need for a flow signal since whistling signals are shown to confuse users
- Face mask (all detachable) included



Item	Description	Qty	\$
BR300	Rigid BreatheRite (no mask)	20	\$95.95
BR302-I	Rigid BreatheRite with Infant Mask	20	\$145.95
BR303-I	Rigid BreatheRite with Sm Child Mask	20	\$145.95
BR304-I	Rigid BreatheRite with Child Mask	20	\$145.95
BR305-I	Rigid BreatheRite with Adult Mask	20	\$145.95



8-3548-10



8-3548-15

Mini-Wright Peak Flow Meter

Includes Patient Use Instructions & Chart

• LATEX FREE • • DISPOSABLE •

- Economical self-monitoring tool to provide and track information about patient's response to treatment
- Ideal for use with asthma, chronic bronchitis and emphysema cases
- Standard Mini-Wright is tubular, with a spring-loaded piston and a longitudinal slot through which air escapes; scale reads from 60 to 850 liters/minute
- Low Mini-Wright monitors the low range from 30 to 400 liters/minute; correlates closely with the Standard Meter

Item	Description	LPM	Qty	\$
8-3548-10	Standard Peak Flow Meter	60-850	1	\$29.95
8-3548-15	Low Range Peak Flow Meter	30-400	1	\$29.95

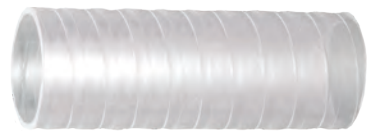

8-3523-24

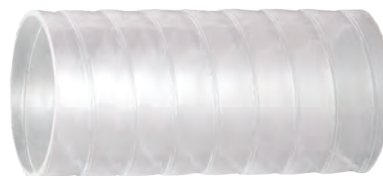

8-3523-20

Mouthpiece

For Use with Mini-Wright Peak Flow Meter

• LATEX FREE • • DISPOSABLE •

- Smooth interior allowing laminar flow
- Constructed of plastic for greater comfort and no cardboard taste
- Large size for standard unit
- Small size for low range unit

Item	Description	Size	Qty	\$
8-3523-20	Large Mouthpiece	2.5" L x 1.1" ID x 1.2" OD	100	\$22.95
8-3523-24	Small Mouthpiece	2.5" L x 0.775" ID x 0.875" OD	100	\$22.95



Adult Inline MDI Adapter

22 mm ID Inlet x 15 mm ID / 22 mm OD Outlet

• DISPOSABLE •

- Use between wye and endotracheal tube adapter
- Directs medication mainstream for ventilator patients
- Arrows clearly mark direction of airflow
- Six inches of tubing can be added to create a chamber if needed
- Accepts plastic or metal tipped metered dose inhaler canisters
- Polystyrene butadiene
- Thermoplastic rubber cap

Item	Description	Qty	\$
3-2422-50	Adult Inline MDI Adapter	50	\$144.95
3-2422-99	Adult Inline MDI Adapter	100	\$261.95



3-6065-09



3-6060-09

Tube Inhaler

For Use with MDI canisters

• LATEX FREE • • REUSABLE •

- Spray application during inspiration
- Suitable for use with intubated patients
- No interruption of ventilation
- Suction post (max 16 CH)
- Autoclavable up to 134°C (273°F)

Item	Description	Qty	\$
3-6065-09	Non-Swivel Tube Inhaler	10	\$196.95
3-6060-25	Double Swivel Tube Inhaler	10	\$205.95
3-6060-09	Single Swivel Tube Inhaler	10	\$186.95



Universal Adult Inline MDI Adapter

22 mm ID x 15 mm ID / 22 mm OD

• DISPOSABLE •

- Accepts new generation MDI canisters with a dose counter or standard MDI canisters
- For use at the Endotracheal Tube
- Directs medication mainstream for ventilator patients
- Arrows clearly mark direction of airflow
- Accepts plastic or metal tipped standard MDI canisters
- Polystyrene butadiene
- Thermoplastic rubber cap

Item	Description	Qty	\$
3-2424-25	Adult Universal Inline MDI Adapter	20	\$95.95
3-2424-50	Adult Universal Inline MDI Adapter	20	\$180.95



Inhalant Mask Meter Dose Elbow

For In-Line Bronchodilation

• LATEX FREE • • REUSABLE •

- Use with metered dose canister (not supplied)
- Machine end is 15 mm male; patient end is nominal 22 mm male and 15 mm female
- Aluminum
- Not for use with counting canisters

Item	Description	Qty	\$
3-0168-60	Inhalant Mask Meter Dose Elbow	1	\$59.95



Open Tube Reservoirs



Closed Bag Reservoirs

SPUR II Resuscitators

Closed Bag or Open Tube Reservoir Options

• LATEX FREE • DISPOSABLE •

- Highly responsive, with minimal mechanical resistance
- Designed for manual ventilation of neonates through adults
- Pressure limiting valve on silicone infant and neonate
- Unique single-shutter valve system for reliable functionality
- Available with or without masks
- Individually packaged in resealable plastic carrying bag
- Color coded sizes for easy identification

Resuscitators with Closed Bag Reservoir

Item	Description	Mask Size	Qty	\$
8-5080-01	Bag Reservoir, Adult	--	12	\$199.95
8-5080-02	Bag Reservoir, Adult	Adult	12	\$216.95
8-5080-04	Bag Reservoir, Med. Adult	Med. Adult	6	\$78.95
8-5080-05	Bag Reservoir, Large Adult	Large Adult	6	\$78.95
8-5080-06	Bag Reservoir, Neonate	Neonate	6	\$78.95
8-5080-07	Bag Reservoir, Pediatric	Infant	6	\$78.95
8-5080-08	Bag Reservoir, Pediatric	Toddler	6	\$78.95
8-5080-11	Bag Reservoir, Infant/Child	--	12	\$223.95
8-5080-12	Bag Reservoir, Infant/Child	00	12	\$247.95
8-5080-13	Bag Reservoir, Infant/Child	0	12	\$247.95
8-5080-14	Bag Reservoir, Infant/Child	1	12	\$247.95
8-5080-21	Bag Reservoir, Neonate	--	12	\$223.95
8-5080-22	Bag Reservoir, Neonate	0	12	\$177.95
8-5080-23	Bag Reservoir, Neonate	1	12	\$177.95

Resuscitators with Open Tube Reservoir

Item	Description	Mask Size	Qty	\$
8-5080-16	Tube Reservoir, Adult	--	6	\$78.95
8-5080-17	Tube Reservoir, Toddler	--	6	\$78.95
8-5080-18	Tube Reservoir, Pediatric	Infant	6	\$78.95
8-5080-19	Bag Reservoir, Neonate	Neonate	6	\$78.95



R500P30
>15 kg



R500P31
1 kg - 15 kg



R500P32
0.25 kg - 6 kg

MaxCap™ CO₂ Indicator

360° Visualization of Color Change

• LATEX FREE • DISPOSABLE •

- EtCO₂ and flow indication device designed for quick visualization of exhaled CO₂ and expiratory flow
- 360° visualization of color change which can be seen from any location around patient
- High definition color changing foam material (purple to yellow)
- Foam will not dry out unlike litmus paper used in many indicators
- Weighs less than other CO₂ indicators for less pull on ET tubes

Item	Description	Size	Qty	\$
R500P30	MaxCap CO ₂ Indicator	Regular	10	\$75.95
R500P31	MaxCap CO ₂ Indicator	Pediatric	10	\$100.95
R500P32	MaxCap CO ₂ Indicator	Neonatal	10	\$170.95



RescuMed Manual Resuscitators

Packaged Specifically for First Responders

• LATEX FREE • DISPOSABLE •

- Equipped standard with bacterial/viral filter to help prevent the spread of potentially infectious expiration content, protecting clinicians, other patients and visitors from cross contamination
- Bacterial/viral filter 99.99% effective at filtering COVID-19, SARS, Ebola, Flu
- Integrated color-coded pressure manometer effectively promotes proper pressure delivery (<20 cm H₂O); the tri-color fields alert to the risk level of delivered pressure
- Pre-attached bacterial/viral filter and mask means no assembly required; grab and go!
- Features appropriately-sized face mask
- B/V filter accepts 19 mm or 30 mm PEEP valves

Item	Description	Size	Qty	\$
BVMB510-F	RescuMed Manual Resuscitator	Adult	6	\$61.95
BVMB810-F	RescuMed Manual Resuscitator	Pediatric	6	\$61.95
BVMV710-F	RescuMed Manual Resuscitator	Infant	6	\$69.95



BVMB510-F



BVMB710-F

BVMB810-F



smiths medical

1st Response™ Manual Resuscitator

Collapsible Volume Bag for Ease of Storage

• LATEX FREE • DISPOSABLE •

- Composed of lightweight clear materials
- Horizontally oriented, low dead space patient valve assembly
- Patient connector with integral swivel improves range of motion
- Long tethered cap for clean, convenient storage of bag after use
- Enhanced SureGrip textured surface helps you maintain a secure grasp
- SureGrip textured resuscitation bag with a tethered dust cap
- Reservoir bag and mask included

Item	Description	Size	Qty	\$
8-8520-00	First Response Manual Resuscitator	Child	9	\$144.95
8-8527-00	First Response Manual Resuscitator	Infant	9	\$221.95
8-8500-00	First Response Manual Resuscitator	Adult	12	\$157.95



smiths medical



Eschmann Endotracheal Tube Introducer & Guides

Reusable Flexible Bougie

• LATEX FREE • REUSABLE •

- Coated braided polyester material provides both stiffness and flexibility at body temperature enabling ease of insertion
- Calibration markings enables safe and easy monitoring of insertion distance
- 10 Fr and 15 Fr guides accommodate full range of ET tubes
- Coudé tip introducer facilitates insertion in adults

Item	Description	Size	Length	Qty	\$
9-0208-60	Adult Blue Line Introducer, Angled Tip for 6-11 mm Tracheal Tubes	15 Fr	60 cm	1	\$60.95
9-0208-13	Standard Blue Line Guide, Straight Tip for 6-11 mm Tracheal Tubes	15 Fr	70 cm	1	\$60.95
9-0208-12	Intermediate Blue Line Guide, Straight Tip for 4-11 mm Tracheal Tubes	10 Fr	70 cm	1	\$60.95

INTERSURGICAL
COMPLETE RESPIRATORY SYSTEMS



InterGuide Tracheal Tube Introducer

Coudé tip on All Sizes

• LATEX FREE • STERILE • DISPOSABLE •

- Atraumatic coudé tip to reduce potential patient trauma
- Low-friction surface for easy insertion and operation
- Allows positive location of the trachea and subsequent placement of ET tube in difficult airway situations



Item	Description	Size	Length	Qty	\$
9-8070-06	Tracheal Tube Introducer, 2.0 mm diameter	6 Fr	530 mm	10	\$59.95
9-8070-10	Tracheal Tube Introducer, 3.3 mm diameter	10 Fr	700 mm	10	\$59.95
9-8070-15	Tracheal Tube Introducer, 5.0 mm diameter	15 Fr	700 mm	10	\$59.95

Bougie Dispenser

Convenient Access to Introducers

• LATEX FREE • REUSABLE •

- Acrylic single- and double-dispenser attaches to carts and walls
- Accommodates up to 10 or 20 packaged introducers
- Mounts with screws or magnets
- Can be easily cleaned
- Mounting hardware sold separately

Item	Description	Qty	\$
9-0212-68	Single Introducer/Bougie Dispenser 2.5" W x 2.24" D x 21.125" H	1	\$29.95
9-0212-69	Double Introducer/Bougie Dispenser 4.875" W x 2.25" D x 21.125" H	1	\$47.95
9-0210-06	Mounting Magnets	2	\$37.95
9-0210-07	Mounting Magnets	4	\$70.95



Mountable anywhere on cart



9-0210-06

SunMed

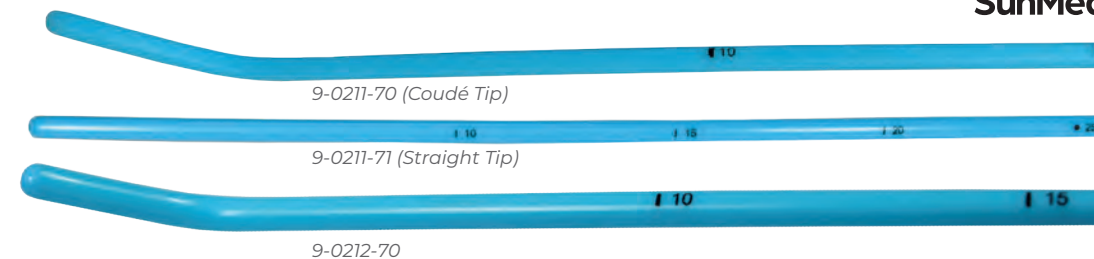

Endotracheal Tube Introducer

The Original Blue Bougie

• LATEX FREE • STERILE • DISPOSABLE •

- Used to guide the endotracheal tube during difficult intubations by sliding over the introducer
- Designed with proper stiffness for ease of insertion
- Calibration markings enables safe and easy monitoring of insertion distance
- Coudé tip facilitates insertion in adults
- Manufactured from low density polyethylene

Item	Description	Size	Length	Qty	\$
9-0212-70	Adult Coudé Tip Extended Introducer Fits 6-11 mm Tubes	15 Fr	70 cm	10	\$63.95
9-0211-70	Pediatric Coudé Tip/Straight Tip Introducer Fits 4-6 mm Tubes	10 Fr	70 cm	10	\$63.95
9-0211-71	Pediatric Coudé Tip/Straight Tip Introducer Fits 4-6 mm Tubes	10 Fr	70 cm	100	\$576.95

Bougie-To-Go™ Introducer

Compact Packaging for Pockets & Paramedic Bags

• LATEX FREE • STERILE • DISPOSABLE •

- Designed specifically for use by EMS professionals
- Unwraps without distorting introducer shape
- Low density polyethylene provides proper stiffness
- Calibrated to ensure accurate distance insertion

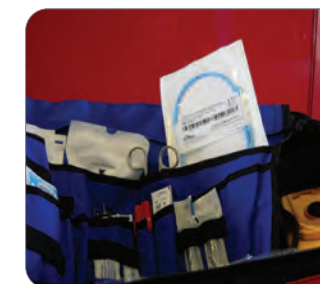

Item	Description	Size	Length	Qty	\$
9-0212-82	Adult Coudé Tip Compact Pocket Size Introducer Fits 6-11 mm Tubes	15 Fr	60 cm	10	\$63.95

Malleable METTS Stylet (Muallem ET Tube)

Soft, Flexible Tip

• LATEX FREE • STERILE • DISPOSABLE •

- Malleable (maintains curvature, inner rod made of metal) with atraumatic flexible soft tip
- New flexible pre-formed soft tip (atraumatic to the tracheal mucosa)
- Graduation marks
- ET Tube can be formed and maintain curvature
- Made of PVC and metal



Item	Description	Size	Length	Qty	\$
9-3308-40	For ET Tube ≥ 3.5 mm	8 Fr	60 cm	5	\$88.95
9-3312-65	For ET Tube ≥ 5.0 mm	12 Fr	65 cm	5	\$88.95
9-3314-65	For ET Tube ≥ 6.0 mm	14 Fr	65 cm	5	\$88.95

INTUBATION AIDS • Stylets

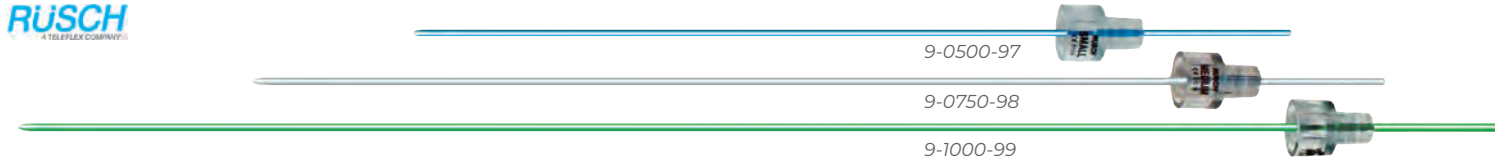

Slick® Stylet

Facilitates First Attempt Intubations with Minimal Risk & Trauma

• LATEX FREE • STERILE • DISPOSABLE •

- Malleable, nylon-coated wire
- Handle forming capabilities for better grip
- Sureloc stop helps maintain desired length for patient safety

Item	Description	Size	Color	Qty	\$
9-1000-99	Adult Slick Stylet Fits 6-11 mm Tubes	10 Fr	Green	25	\$92.95
9-0750-98	Small Adult/Child Slick Stylet Fits 4-7 mm Tubes	8 Fr	Gray	25	\$92.95
9-0500-97	Pediatric/Neonate Slick Stylet Fits 2-3.5 mm Tubes	6 Fr	Blue	25	\$92.95



SunGlide™ Coated Stylet

Malleable to Any Shape

• LATEX FREE • STERILE • DISPOSABLE •

- Adjustable stop enables the user to position the stylet tip so as to not protrude beyond the end of the ET tube
- Reduced surface tension removes need for lubricants
- Color coded stoppers for easy size recognition
- Easy open packages

Item	Description	Size	Color	Qty	\$
9-0209-73	Adult SunGlide Stylet Fits 7-10 mm Tubes	10 Fr	Green	25	\$76.95
9-0209-72	Child SunGlide Stylet Fits 4-7 mm Tubes	8 Fr	Gray	25	\$76.95
9-0209-71	Neonate SunGlide Stylet Fits 2-3.5 mm Tubes	6 Fr	Blue	25	\$76.95



Malleable Stylet

Combined Benefits of an Introducer & Stylet in One Unit

• LATEX FREE • STERILE • DISPOSABLE •

- Manufactured with an internal wire for reshaping the styler prior to use, thus controlling insertion direction
- Non-PVC
- Graduation marks
- For use with ET tubes, rigid bronchoscope and laryngeal mask airways

Item	Description	Size	Length	Qty	\$
9-0213-92	Adult Malleable Stylet	15 Fr	70 cm	10	\$65.95
9-0213-82	Pediatric Malleable Stylet	10 Fr	70 cm	10	\$65.95



Safety Stylet

Malleable Endotracheal Tube Guide with End Cap

• LATEX FREE • STERILE • DISPOSABLE •

- Unique end cap prevents forward migration of stylet during intubation
- Hollow core end cap allows audible breath sounds while in place
- Facilitates placement of the safety stylet in desired position in ET tube

Item	Description	Qty	\$
9-2102-14	Adult Safety Stylet	20	\$93.95
9-2102-16	Small Adult Safety Stylet	20	\$93.95
9-2102-18	Pediatric Safety Stylet	20	\$93.95

Stylets • INTUBATION AIDS



Flexi-Slip™ Stylet

Low Friction Coating

• LATEX FREE • STERILE • DISPOSABLE •

- Malleable core
- Soft atraumatic tip

Item	Description	Size	Length	Qty	\$
9-5025-03	Flexi-Slip Stylet Fits 4-6.5 mm Tubes	10 Fr	44 cm	20	\$55.95
9-5025-05	Flexi-Slip Stylet Fits 5-10 mm Tubes	12 Fr	45 cm	20	\$55.95
9-5025-07	Flexi-Slip Stylet Fits 7-10 mm Tubes	14 Fr	45 cm	20	\$73.95

Satin Finish Stylet

Reduce Friction

• LATEX FREE • STERILE • DISPOSABLE •

- Malleable
- Smooth rounded end

Item	Description	Size	Length	Qty	\$
9-0204-11	Pediatric Satin Finish Stylet	6 Fr	11"	25	\$29.95
9-0204-25	Adult Malleable Stylet	9 Fr	16"	25	\$29.95

Copper Stylet

Malleable

• LATEX FREE • DISPOSABLE •

- Solid copper has adjustable stops
- Hollow copper has suction port

Item	Description	Length	Qty	\$
9-0203-00	Solid Copper Malleable Stylet w/ Adjustable Stop	14.75"	1	\$9.95
9-0206-01	Hollow Copper Malleable Stylet w/ Suction	16.5"	1	\$17.95

Stainless Steel Stylet

Available in Adult & Infant Sizes

• LATEX FREE • REUSABLE •

- Surgical stainless steel
- Malleable

Item	Description	Length	Qty	\$
9-0207-03	Adult Stainless Steel Stylet	16.5"	1	\$6.95
9-0207-01	Infant Stainless Steel Stylet	11.5"	1	\$5.95
9-0210-05	Stylet Stops	--	5	\$7.95

Aluminum Stylet

Available in Adult & Pediatric Sizes

• LATEX FREE • DISPOSABLE •

- Smooth, rounded end
- Malleable

Item	Description	Length	Qty	\$
9-0204-00	Adult Aluminum Stylet	16"	1	\$4.95
9-0204-10	Adult Aluminum Stylet	16"	10	\$39.95
9-0204-12	Pediatric Aluminum Stylet	12"	1	\$4.95
9-0204-22	Pediatric Aluminum Stylet	12"	10	\$39.95

INTUBATION AIDS • Stylets

smiths medical



9-9020-00

Stainless Steel Intubation Stylet

Malleable Stylet

• LATEX FREE • STERILE • DISPOSABLE •

- Constructed of stainless steel wire
- Satin smooth coating reduces friction and binding

Item	Description	Qty	\$
9-9020-00	Stainless Steel Malleable Stylet Fits 2.5-4.5 mm Tubes	10	\$33.95
9-9020-01	Stainless Steel Malleable Stylet Fits 5-7 mm Tubes	10	\$33.95
9-9020-03	Stainless Steel Malleable Stylet Fits 7.5-10 mm Tubes	10	\$33.95

SunMed



9-0203-14

9-0203-10

9-0203-06

Clear PVC Coated Stylet

Smooth Insertion

• LATEX FREE • STERILE • DISPOSABLE •

- Malleable aluminum
- Sealed in a PVC sheath

Item	Description	Size	Qty	\$
9-0203-06	Clear PVC Coated Stylet, 10"	6 Fr	20	\$52.95
9-0203-10	Clear PVC Coated Stylet, 11.5"	10 Fr	20	\$52.95
9-0203-14	Clear PVC Coated Stylet, 12.5"	14 Fr	20	\$52.95

SALTER LABS



H-STLT-10-20

Malleable Aluminum Stylet

Curve as Needed

• LATEX FREE • STERILE • DISPOSABLE •

- Malleable aluminum
- Sealed in a PVC sheath
- Blunt tip reduces risk of trauma

Item	Description	Size	Qty	\$
H-STLT-6-20	Metal Stylet, 2.0 mm OD	6 Fr	20	\$40.95
H-STLT-10-20	Metal Stylet, 3.3 mm OD	10 Fr	20	\$40.95
H-STLT-14-20	Metal Stylet, 4.7 mm OD	14 Fr	20	\$40.95

INTERSURGICAL
COMPLETE RESPIRATORY SYSTEMS



9-8080-10



Aluminum core allows user to easily form suitable shapes

InterForm Stylet

Malleable Aluminum

• LATEX FREE • STERILE • DISPOSABLE •

- Low friction surface for easy insertion and removal
- Allows user to form ET tube into suitable shape for easy insertion and give more control of airway device

Item	Description	Size	Length	Qty	\$
9-8080-06	InterForm Stylet, 2.0 mm OD	6 Fr	275 mm	10	\$29.95
9-8080-10	InterForm Stylet, 3.3 mm OD	10 Fr	340 mm	10	\$29.95
9-8080-14	InterForm Stylet, 4.7 mm OD	14 Fr	340 mm	10	\$29.95

Lighted Stylets • INTUBATION AIDS

Bovie AARON MEDICAL

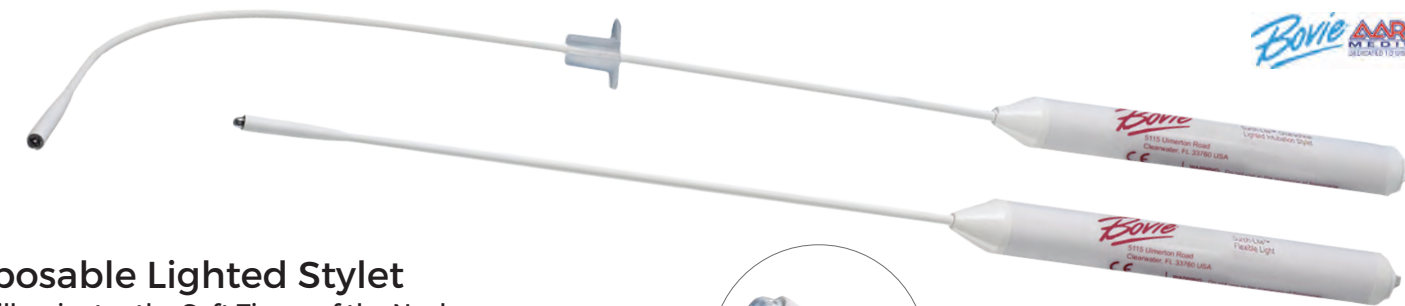

Disposable Lighted Stylet

Transilluminates the Soft Tissue of the Neck

• LATEX FREE • DISPOSABLE •

- Assist in the proper placement of an endotracheal tube without direct visualization of the cords
- Designed for emergency and trauma situations in the field, ER and intubation in the OR
- Can serve as an effective alternative to the standard laryngoscope
- Adjustable endotracheal tube adapter for use with a variety of sizes
- Provides minimal neck flexion in trauma cases
- 4 year shelf life

Item	Description	Length	Qty	\$
9-0222-20	Adult Lighted Stylet, Non-Sterile	15.75"	1	\$37.95
9-0222-19	Adult Lighted Stylet, Sterile	15.75"	1	\$42.95

SunMed



9-0204-18

9-0204-14

Reusable Fiber Optic Stylet

Cool White Illumination of Airway

• LATEX FREE • REUSABLE •

- Xenon Fiber optic light is cool white and improves visibility
- Eliminates possibility of a bulb being dropped in the airway
- Adjustable stops (single use, disposable)
- Available in two sizes

Item	Description	Length	Qty	\$
9-0204-14	Pediatric Reusable Fiber Optic Stylet	14"	1	\$74.95
9-0204-18	Adult Reusable Fiber Optic Stylet	18"	1	\$74.95
9-0240-59	Xenon Fiber Optic Replacement Bulb	-	-	\$15.00
9-0210-05	Disposable Replacement Stops	-	15	\$7.95

SALTER LABS

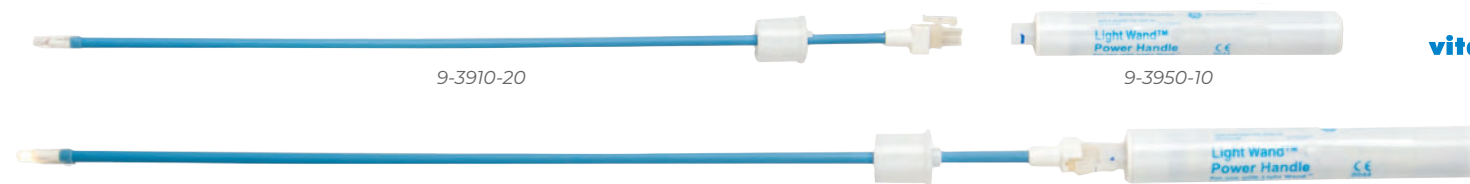

9-3910-20

9-3950-10

Transtracheal Illuminating Stylet

Exceptionally Bright Light for Intubation & Position Verification

• LATEX FREE • DISPOSABLE •

- Protective coating on bulb reduces heat transmission
- Self-contained handle unit - no batteries to replace, no switch to fail
- Eliminates reprocessing costs and prevent cross contamination
- Stylet is flexible for use with or without a laryngoscope
- Applicable for the difficult airway and routine intubations

Item	Description	Qty	\$
9-3950-10	Illuminating Stylet Wand Battery Pack Handle	10	\$306.95
9-3910-20	Detachable Transtracheal Illuminating Stylet Fits 6 mm + Larger ET Tubes	20	\$378.95

vital signs

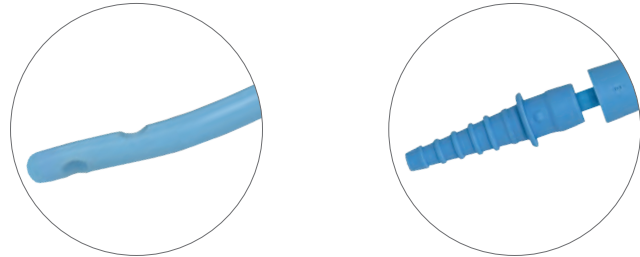

Adult Ported Introducer
Can Facilitate Oxygenation, Suctioning

- LATEX FREE • STERILE • DISPOSABLE •
- Suitable for providing oxygenation during intubation or eliminating light secretions
- Suction and extract tracheal gas samples for analysis
- Removable hose barb and 15 mm male fitting
- Coudé tip with two eyes
- Graduation marks

Item	Description	Size	Length	Qty	\$
9-0212-80	For ET Tubes 6.0-11.0 mm	6 Fr	70 cm	10	\$62.95



3-3468-02

Tube Exchanger
Includes O₂ Connector

- LATEX FREE • STERILE • DISPOSABLE •
- Lumen design
- Graduation marks

Item	Description	Size	Qty	\$
3-3458-01	ET Tube Exchanger Fits 4 mm ID	11 Fr	5	\$116.95
3-3468-02	ET Tube Changer Fits 5 mm ID	14 Fr	5	\$116.95
3-3478-01	ET Tube Changer Fits 7 mm ID	19 Fr	5	\$116.95

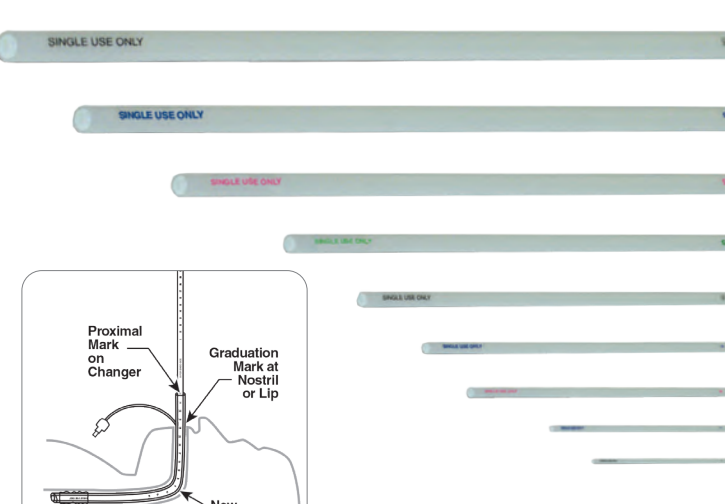

Length and diameter are size specific - not interchangeable

Endotracheal Tube Changer
Simple, Quick Technique for Changing ET Tubes

- LATEX FREE • DISPOSABLE •
- Entire procedure requires 30 to 120 seconds
- Available for all sizes of ET Tubes
- Graduated marks for easy, accurate placement of new tube
- High density polyethylene
- Smooth round tip
- No laryngoscope needed

Item	Description	Qty	\$
9-0202-25	ET Tube Changer Fits 2.5 mm ID	10	\$110.95
9-0202-30	ET Tube Changer Fits 3 mm ID	10	\$110.95
9-0202-40	ET Tube Changer Fits 4 mm ID	10	\$110.95
9-0202-50	ET Tube Changer Fits 5 mm ID	10	\$110.95
9-0202-55	ET Tube Changer Fits 5.5 mm ID	10	\$110.95
9-0202-60	ET Tube Changer Fits 6 mm ID	10	\$110.95
9-0202-65	ET Tube Changer Fits 6.5 mm ID	10	\$110.95
9-0202-70	ET Tube Changer Fits 7 mm ID	10	\$110.95
9-0202-99	ET Tube Changer Fits 7.5 mm ID	10	\$110.95
9-0202-00	ET Tube Changer Combo Pack Includes One of Each Size Above	1	\$99.95



Malleable Intubating S-Guide
Oral Tracheal "Dancing Tube" with Oxygenation

- LATEX FREE • REUSABLE •
- Combined malleable stylet, introducer with preformed orange-colored soft tip and oxygenation channel in one unit
- S-Guide unifies all the essential intubation features with marks to indicate positioning
- Works with conventional, video and blind intubation
- Hollow lumen enables oxygenation
- Malleable segment has an appropriate stiffness to ease maneuverability

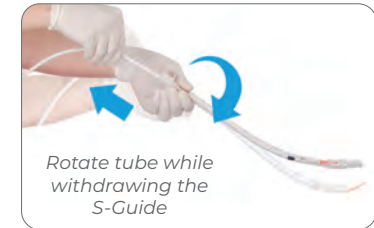

Item	Description	Size	Length	Qty	\$
9-3390-65	Malleable Intubating Guide for ET Tubes ≥ ID 6.0 mm	15 Fr	65 cm	5	\$88.95



Introducer
Includes O₂ Connector

- LATEX FREE • STERILE • DISPOSABLE •
- Lumen design with O₂ connector included
- Allows for oxygenation via universal connector
- Rigid, preformed tip and graduation marks

Item	Description	Size	Length	Qty	\$
3-3500-65	For ET Tubes ≥ ID 5.0 mm	14 Fr	65 cm	5	\$70.95

Rapid Positioning Intubation Stylet
Assists in Managing Difficult Intubations Successfully

- LATEX FREE • STERILE • DISPOSABLE •
- Controllable tip can flex and retro-flex
- Allows distal tip control from single practitioner to improve speed and success of intubation
- Can be used with video and direct laryngoscopy

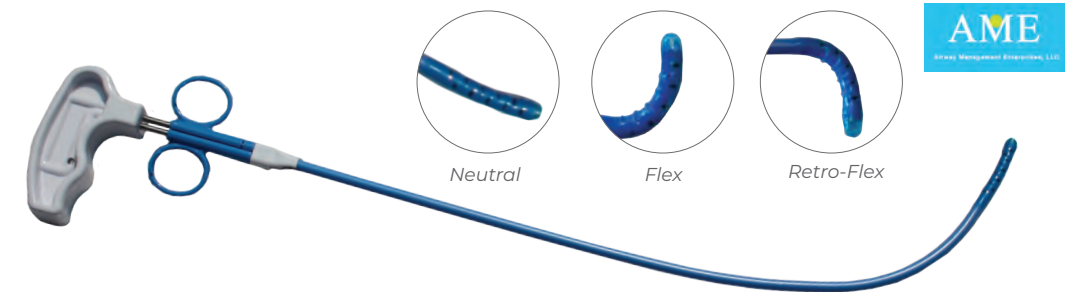

Item	Description	Qty	\$
9-4200-01	Rapid Positioning Stylet	1	\$53.95

Flexible Tip Bougie
Maneuverable Tip for Managing Difficult Airways

- LATEX FREE • STERILE • DISPOSABLE •
- Works well with conventional, video and blind intubation
- Innovative slider is used between the thumb and forefinger to move the tip anteriorly and posteriorly
- Blunt tabs make it easy to grip and maneuver slider even with gloved hands
- Slider tabs are positioned on the bougie so they will not need to pass through vocal cords

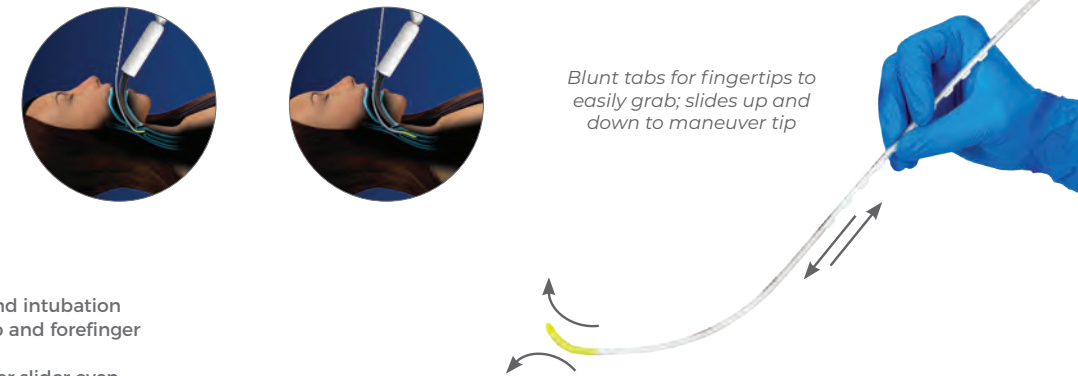

Item	Description	Qty	\$
9-4200-18	Flexible Tip Bougie	10	\$189.95

Find What You Need

A

Absorbents
 Carbon Dioxide..... 132
 Aillon Tube Bender..... 36
 Airway Management..... 4-37
 Adjustable Flange..... 10
 Berman..... 4-5
 Bronchial Catheters..... 26-28
 Cath-Guides..... 5
 Double Lumen..... 27
 Endobronchial Tubes..... 26-28
 Endotracheal Tubes..... 14-25
 Guedel..... 6-7
 Laryngeal Masks (Supraglottic)..... 30-35
 Nasopharyngeal..... 10-13
 Oropharyngeal..... 4-8
 Ovassapian..... 8
 Preformed..... 21-25
 Reinforced..... 18
 Robertazzi..... 11
 Robertshaw Tubes..... 26-27
 Tracheostomy..... 28
 Williams..... 8
 Airway Intubation Kits..... 44, 73
 Aneroid Kits..... 90
 Anesthesia
 Circuits..... 128-129
 Labels, Label Tape..... 111
 Masks..... 122-123
 Needles..... 108-109
 Atomizer..... 124

B

Bacterial/Viral Filters..... 135, 137
 Berman Airways..... 4-5
 Bite Blocks..... 98
 Blood Pressure..... 90-94
 Accessories..... 94
 Aneroid Systems..... 90
 Bariatric Cuffs..... 92
 Double Stem Cuff Systems..... 93
 Single Stem Cuff Systems..... 92
 Bougie Introducers..... 150-151
 Breathing Bags..... 126
 Bronchial Catheters..... 26-28
 Bubble Humidifiers..... 118
 Bulbs, Laryngoscope..... 58, 74

C

Cables and Adapters..... 96-97
 Cannulas..... 112-119
 Capnography..... 112-115
 Oxygen Delivery..... 119
 Securement..... 118

Capnography
 Cannulas..... 112-115, 162
 Face Masks..... 116
 Monitors..... 114
 Carts, O₂ Cylinder..... 142
 Cath-Guide Airways..... 5
 Chemetron Stems..... 141
 Chestpiece Set..... 82
 Christmas Tree Connectors..... 142
 Circuits..... 128-131
 CPAP..... 117
 Connectors
 Endotracheal..... 144
 Gas..... 140-141
 Oxygen..... 131, 140-141
 Racine Universal..... 145
 Right Angle..... 144
 Rubber/Neoprene..... 145
 Straight..... 144
 Tube Inhaler..... 147
 Cleaning Brushes..... 36
 CO₂ Absorbents..... 132
 CO₂ Detection..... 133
 Cricothyroidotomy..... 9
 CRNA Training Kits..... 82
 Cuff Monitors..... 37
 Cylinder Carts and Racks..... 142

D

Diagnostics..... 78-97
 Diagnostic Kits..... 82
 Derbyshire Tube Support..... 127
 Disposable Laryngoscopes..... 38-46
 Blades..... 38-46
 Handles..... 38-46
 Kits..... 43, 44, 46
 Dual Cannulas..... 112-115

E

Emergency Products
 Cricothyroidotomy..... 9
 Intubation Kits..... 44, 73
 Jaw Spreader..... 5
 Jet Vent Catheters..... 138-139
 Jet Ventilators..... 138-139
 Quicktrach, Quicktrach II..... 9
 Resuscitators..... 148-149
 Tracheostomy Tubes..... 28
 Endobronchial Tubes..... 26-28
 Endotracheal Securement..... 29
 Endotracheal Tubes..... 14-25
 Connectors..... 144
 Cuffed..... 14-25
 Preformed..... 21-25

Reinforced..... 17, 18
 Stylet..... 15, 17, 19, 20
 Tracheostomy Tubes..... 28
 Uncuffed..... 14-25
 Epidural..... 104, 108
 Needles..... 108
 Positioners..... 104
 Equipment Covers..... 105
 Eschmann ET Tube Introducers..... 150
 Esophageal Stethoscopes..... 86, 88
 ETCO₂ Cannulas..... 112-116
 Eye Protection..... 99, 100

F

Filtration
 Bacterial & Viral..... 153
 HMEFs..... 136-137
 HEPA Filter..... 135, 161
 Flexible Tubing..... 145
 Flowmeters..... 140
 Forceps..... 103

G

Gas Sampling..... 114
 Gastro-Laryngeal Tubes..... 35
 Gel Positioners..... 102
 Guedel Airways..... 6-7

H

Harnesses for Masks..... 125, 161
 Heat-Moisture Exchanger..... 137
 HEPA Filters..... 135, 161
 High-Concentration Masks..... 117
 HME / HMEFs..... 136-137
 Hoses
 Corrugated Tube Adapter..... 145
 Corrugated Hose..... 145
 Flexible..... 145
 Howland Lock..... 59
 Humidifiers..... 118

I

Instruments..... 103
 Introducers..... 150-151, 156-157
 Eschmann..... 150
 Original Bougie..... 151
 Malleable Bougie..... 151
 Metti Introducer..... 156
 Ported..... 156
 Pocket Introducers..... 151
 Intubating Stylets..... 152-155
 Intubation Kits..... 55-57
 IV Catheters..... 109
 IV Poles..... 107

J

Jaw Elevation..... 101
 Jaw Spreader..... 5
 Jet Ventilators..... 138-139
 Jet Vent Catheters..... 138-139

L

Labels and Label Tape..... 111
 Lamps, Laryngoscope..... 58, 74
 Laryngeal Mask Airways..... 30-35
 Laryngoscopes - Fiber Optic..... 47-65
 Disposable..... 38-46
 Flex-Tip..... 49
 Handles..... 58, 59, 60, 62, 63, 64
 Howland Lock..... 59
 Kits..... 55-57
 Lamps..... 58, 60
 Macintosh Blades..... 47-52, 62-65
 Miller Blades..... 47-48, 51-54, 61, 63-65
 MRI Compatible..... 64-65
 Specialty Blades..... 49-54, 61-62
 Laryngoscope - Standard/Conventional..... 66-77
 Disposable..... 46
 Handles..... 74-75
 Kits..... 71
 Lamps..... 74
 Macintosh Blades..... 66-68, 71-72, 76-77
 Miller Blades..... 66-70, 76-77
 Specialty Blades..... 69-72
 LED Handles..... 38, 41, 42, 45, 58-63
 Lighted Stylets..... 155

M

Manual Suction Pump..... 138
 Masks
 Aerosol Therapy..... 120
 Anesthesia..... 122-123
 Capnography..... 116
 Endoscopy..... 124
 Harness..... 125, 161
 Non-Rebreathing..... 117
 O₂ Mask..... 120
 Spray..... 125
 Medication Delivery..... 146-147
 MDI Inhalers..... 147
 Monoscope..... 82
 Monitor Cables..... 87, 96-97



more great products online

N

Nasal Pillows..... 117
 Nasopharyngeal Airways..... 10-13
 Nebulizers..... 120, 121
 Needles..... 108-109
 Anesthesia..... 108
 Epidural..... 108
 Sprottle..... 109
 Tuohy..... 109
 Nerve Stimulators..... 78-81
 Nose Clips..... 100

O

Operating Room
 Arm / Leg Shields..... 103
 Positioners..... 101-102, 104
 Instruments..... 103
 Ohmeda Stems..... 141
 Oropharyngeal Airways..... 4-8
 Oxygen
 Carts, Racks..... 142
 Flow Valves..... 143
 O₂ Sensors..... 95
 O₂ Connectors and Cables..... 96-97
 Cylinder Stands..... 142
 Flowmeters..... 140
 Regulators..... 140, 143
 Sensors..... 95
 SPO₂ Sensors..... 96-97

P

Patient Care Stands..... 107
 Patil Intubation Guide..... 36
 Peak Flowmeters..... 146
 PEEP Valves..... 134
 Peripheral Nerve Stimulators..... 78-81, 161
 Positioners..... 101-102
 Anti-Microbial..... 102
 Covered..... 101
 Gel..... 102
 Jaw Elevation..... 101
 Neonatal..... 102
 Precordial Accessories..... 82
 Pressure Gauges..... 37
 Pressure Infusion Bags..... 106
 Pulse Oximeters..... 83

Q

Qualitative Nerve Stimulators..... 78-80
 Quantitative Nerve Stimulators..... 80-81
 Quicktrach, Quicktrach II..... 9

R

Racine Universal Connector..... 145
 Regulators..... 140, 143
 Respiratory..... 112-149
 Circuits..... 128-131
 Masks & Accessories..... 122-125
 Ventilators..... 148-149
 Resuscitators, Manual..... 149
 Robertazzi Airways..... 11

S

Safety Products
 Bite Blocks..... 98
 Eye Protection..... 99, 100
 Face Protection..... 100
 Hy Tape..... 100
 Tooth Protection..... 98
 SPO₂ Sensors / Cables..... 96-97
 Stethoscopes..... 83
 Stop Cocks, 3-Way..... 143
 Stylets
 Copper..... 153
 Lighted..... 155
 Specialty..... 152-155
 Stainless Steel..... 153

T

Temperature Monitoring..... 84-89
 Connectors..... 87-88
 Probes..... 86-87
 Sensors..... 88
 Temp Trend Indicators / Strips..... 84-85
 Thermometer..... 89
 Test Lungs..... 126
 Tooth Protection..... 98
 Tracheal Tubes..... 14-25
 Tracheal Tube Connectors..... 144
 Tracheostomy Tubes..... 28
 Transport Circuits..... 130
 Tube Changers..... 156
 Tube Support / Trees..... 127

U

Universal ET Tube Connector..... 145

V

Vaporizer Filler..... 110
 Ventilators
 Jet..... 138-139
 Manual..... 160

W

Wheel Covers..... 105



GO2VENT® Gas Operated Ventilator Hands Free Ventilation Support

LATEX FREE • REUSABLE •

- GO2VENT provides “hands free” ventilator support via a secure airway using a continuous gas source
- Can be operated on a compressor, oxygen or air with a minimum of 10 Liters per minute flow rates
- Does not require the use of electricity or batteries – it is an ideal backup ventilator for the management of difficult situations such as mass casualties, natural disasters, disease outbreaks, major power outages
- Perfect solution for transportation needs, in or out of the hospital
- For patients 10 kilograms and above
- Includes the VORTRAN Manometer
- 50% or 100% FiO₂ entrainment option



Item	Description	Qty	\$
8-6123-10	GO2VENT Ventilator	10	\$1169.95

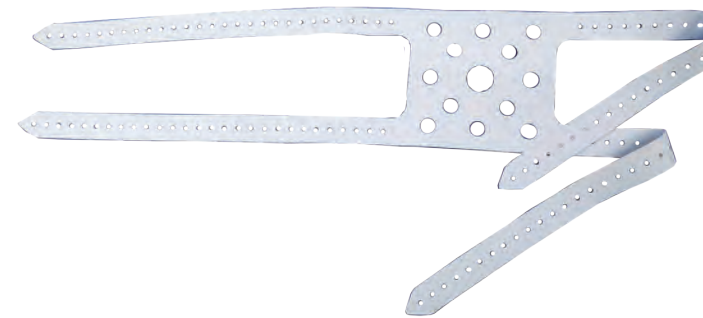

Blue Mask Head Harness Webbed Head Portion Permits Ventilation

LATEX FREE • DISPOSABLE •

- Light blue molded head harness
- Equal distribution of pressure over large area
- Designed to ensure proper fit

Item	Description	Size	Qty	\$
4-1054-01	Blue Mask Head Harness	Adult	1	\$5.95



HEPA Filter Effectively Filters for COVID-19

LATEX FREE • DISPOSABLE •

- Bacterial/viral filtration
- Sampling port
- 99.9999% Filtration efficacy
- 22mm OD/15 mm ID x 22 mm ID/15 mm OD
- 62 mL Dead-space
- 250 mL - 1500 mL tidal volume

Item	Description	Qty	\$
FH603074	HEPA Filter	50	\$169.95



RescuMed™ Manual Resuscitators Complete with B/V Filter to Protect Against COVID

LATEX FREE • DISPOSABLE •

- Equipped standard with bacterial/viral filter to help prevent the spread of potentially infectious expiration content, protecting clinicians, other patients and visitors from cross contamination
- Bacterial/viral filter 99.99% effective at filtering COVID-19, SARS, Ebola, Flu
- Integrated color-coded pressure manometer effectively promotes proper pressure delivery (<20 cm H₂O); the tri-color fields alert to the risk level of delivered pressure
- Pre-attached bacterial/viral filter and mask means no assembly required; grab and go!
- Features appropriately-sized face mask
- B/V filter accepts 19 mm or 30 mm PEEP valves

Item	Description	Size	Qty	\$
BVMB510-F	RescuMed Manual Resuscitator	Adult	6	\$61.95
BVMB810-F	RescuMed Manual Resuscitator	Pediatric	6	\$61.95
BVMV710-F	RescuMed Manual Resuscitator	Infant	6	\$69.95



BVMB510-F

BVMB710-F

BVMB810-F

SunStim™ Pro LED Screen Displays Functionality

LATEX FREE • REUSABLE •

- Ergonomic, compact shape fits comfortably in hand
- Easy-to-Read illuminated digital screen displays DBS, Twitch, Tetanus, TOF, current intensity and battery life
- Clearly visible, finger-controlled front face buttons
- Side switch to increase and decrease level of stimulation
- Removable silicone wrap enhances grip, helps protect device



Item	Description	\$
8-1053-63	SunStim Pro Peripheral Nerve Stimulator	\$259.95



MainlineMedical.com
more great products online



EtCO₂ / O₂ Sampling Cannula with Reflective Connector

Compatible with Leading CPAP Monitors

• LATEX FREE • DISPOSABLE •

- Compatible with Microstream™, Capnostream™ and Oridion™ capnography monitors
- Dual nasal cannula simultaneously provides oxygen to both nostrils while obtaining CO₂ sampling during spontaneous breathing
- Designed to prevent mixing of fresh oxygen with CO₂
- Innovative scoop design suitable for mouth-breathing patients
- 3-Channel tubing prevents kinking
- Adult and pediatric sizes in three tubing lengths
- DEHP free

EtCO₂ / O₂ Cannula with Reflective Connector

Item	Description	Size	Length	25/Pk \$
5107F-SE	EtCO ₂ /O ₂ Nasal Cannula	Adult	7'	\$156.95
5110F-SE	EtCO ₂ /O ₂ Nasal Cannula	Adult	10'	\$172.95
5114F-SE	EtCO ₂ /O ₂ Nasal Cannula	Adult	14'	\$189.95
5207F-SE	EtCO ₂ /O ₂ Nasal Cannula	Pediatric	7'	\$198.95
5210F-SE	EtCO ₂ /O ₂ Nasal Cannula	Pediatric	10'	\$218.95
5214F-SE	EtCO ₂ /O ₂ Nasal Cannula	Pediatric	14'	\$240.95

Filter integrated with reflective connector helps prevent moisture collection

Fits-All O₂ connector comes standard on all sizes and lengths

Scoop design effectively captures end tidal sampling from mouth breathing patients

Soft-Ears™ material ensures superior patient comfort, even during prolonged use



EtCO₂ / O₂ Cannula with Reflective Connector, Scoop

Item	Description	Size	Length	25/Pk \$
5707F-SE	EtCO ₂ /O ₂ Oral/Nasal Cannula	Adult	7'	\$184.95
5710F-SE	EtCO ₂ /O ₂ Oral/Nasal Cannula	Adult	10'	\$203.95
5714F-SE	EtCO ₂ /O ₂ Oral/Nasal Cannula	Adult	14'	\$223.95

Microstream, Capnostream, and Oridion are trademarks of Oridion Medical 1987, Ltd. related to products marketed by Medtronic.



Flex-Tip® Endotracheal Tubes

Tapered Distal Tip for Non-Traumatic Intubation

• LATEX FREE • STERILE • DISPOSABLE •

- Designed to facilitate rapid, non-traumatic intubation
- Unique, patented design has a flexible, curved, centered, tapered distal tip
- Tapered tip is designed to flex and slide gently along the airway through the larynx, down the trachea on its curved backside without catching on airway tissue

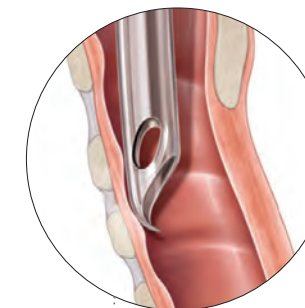

Tapered tip slides more gently along airway compared to traditional ET tubes

SEE THE DIFFERENCE • EXPERIENCE THE DIFFERENCE



FLEX-TIP ET TUBE

- NO GAP between tapered tip of ET tube and fiber bundle



STANDARD ET TUBE

- Gap between leading edge of ET tube and fiber bundle
- Gap can catch on airway anatomy as the tube is 'railroaded' downward



Uncuffed

Item	I.D.	Qty	\$
H-PFUO-25	2.5 mm	10	\$20.95
H-PFUO-30	3.0 mm	10	\$20.95
H-PFUO-35	3.5 mm	10	\$20.95
H-PFUO-40	4.0 mm	10	\$20.95
H-PFUO-50	5.0 mm	10	\$20.95
H-PFUO-55	5.5 mm	10	\$20.95
H-PFUO-60	6.0 mm	10	\$20.95
H-PFUO-65	6.5 mm	10	\$20.95
H-PFUO-70	7.0 mm	10	\$20.95

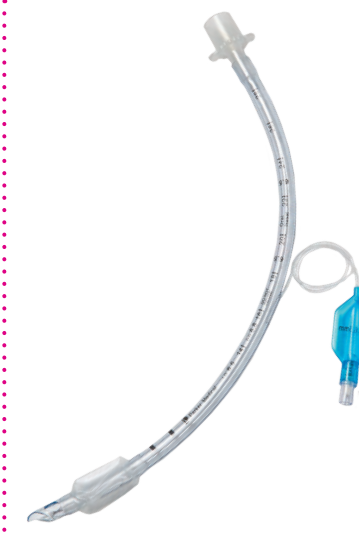

Cuffed

Item	I.D.	Qty	\$
H-PFHV-40	4.0 mm	10	\$18.95
H-PFHV-50	5.0 mm	10	\$18.95
H-PFHV-55	5.5 mm	10	\$18.95
H-PFHV-60	6.0 mm	10	\$18.95
H-PFHV-65	6.5 mm	10	\$18.95
H-PFHV-70	7.0 mm	10	\$18.95
H-PFHV-75	7.5 mm	10	\$18.95
H-PFHV-80	8.0 mm	10	\$18.95
H-PFHV-85	8.5 mm	10	\$18.95
H-PFHV-90	9.0 mm	10	\$18.95
H-PFHV-95	9.5 mm	10	\$18.95

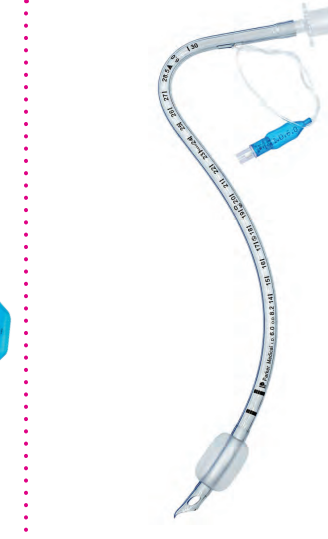

Nasal Cuffed

Item	I.D.	Qty	\$
H-PFNC-40	4.0 mm	10	\$23.95
H-PFNC-50	5.0 mm	10	\$23.95
H-PFNC-55	5.5 mm	10	\$23.95
H-PFNC-60	6.0 mm	10	\$23.95
H-PFNC-65	6.5 mm	10	\$23.95
H-PFNC-70	7.0 mm	10	\$23.95
H-PFNC-75	7.5 mm	10	\$23.95
H-PFNC-80	8.0 mm	10	\$23.95
H-PFNC-85	8.5 mm	10	\$23.95
H-PFNC-90	9.0 mm	10	\$23.95



Oral Cuffed

Item	I.D.	Qty	\$
H-PFOC-40	4.0 mm	10	\$23.95
H-PFOC-50	5.0 mm	10	\$23.95
H-PFOC-55	5.5 mm	10	\$23.95
H-PFOC-60	6.0 mm	10	\$23.95
H-PFOC-65	6.5 mm	10	\$23.95
H-PFOC-70	7.0 mm	10	\$23.95
H-PFOC-75	7.5 mm	10	\$23.95
H-PFOC-80	8.0 mm	10	\$23.95
H-PFOC-85	8.5 mm	10	\$23.95
H-PFOC-90	9.0 mm	10	\$23.95

Customer Number

Priority Code

Always FREE Shipping Online with \$500+ Orders • MainlineMedical.com

NebuTech® Nebulizer

Exceptional Performance, Versatility and Efficiency

• LATEX FREE •

- Delivers front-loaded bolus dosing during critical first 1/3 of each breath
- Provides drug deposition deep into the lungs
- High quality aerosol – 80% of particles in the respirable range (<5 microns)
- Improved patient outcomes translate into financial benefits
- Quick yet effective treatment – 50% shorter treatment times than AeroEclipse II
- 82% of treatments completed in less than 3 minutes
- 45° angle for maximizing patient comfort and treatment compliance
- Patient-friendly accessories provide flexible and improved respiratory treatment
- Mask, filter, and positive expiratory pressure (PEP) available
- Filter provides RT protection from exhaled medications
- Spans the full continuum of patient care: pediatrics through elderly



NebuTech's Effective Drug Delivery & Patient Adaptability Can:

- Lower number of patient treatments required
- Reduce overall patient stay
- Help lower patient re-admission rates
- Promote patient compliance with in-home treatment

Item	Description	Qty	\$
8992TG-7-50	NebuTech Nebulizer, Aerosol Mask, 7' Tubing, TG Connector, B/V Adapter, Expiratory Filter	50	\$243.95
8990-7-50	NebuTech Nebulizer Mouthpiece, 7' Tubing, B/V Adapter, Expiratory Filter	50	\$299.95
8990TG-7-50	NebuTech Nebulizer, Mouthpiece, 7' Tubing, TG Connector, B/V Adapter, Expiratory Filter	50	\$299.95
8992-7-50	NebuTech Nebulizer, Aerosol Mask, 7' Tubing, B/V Adapter, Expiratory Filter	50	\$243.95

Inside!



AccuTherm™ Temperature Indicator

Pg. 84



ToFscan® Neuromuscular Transmission Monitor

Pg. 81



To Order/Contact Us:

Call Us 1-800-366-2084
Fax Us 1-800-261-3066
Email Us info@MainlineMedical.com
Order Online www.MainlineMedical.com

Payment Options:

Credit Cards accepted: Visa, MasterCard, American Express, and Discover.

If you would like to set up an account, call us. Doctors, Nurses, Therapists and other Healthcare Professionals receive the same discounted prices given to Hospitals and Surgery Centers.

Terms and Conditions:

If you receive items that do not meet your expectations, you may return them if in salable condition to Mainline Medical for credit or replacement. Please contact our Customer Care Department at 1-800-366-2084 for a return authorization.

Full credit will be given for items returned in salable condition within 30 days. Special orders and sterile items are not returnable. Restocking fees may apply. Freight charges are not refundable.

We make every effort maintain the prices printed in this catalog and to provide you with the most up-to-date and accurate information. However, occasionally we receive price increases from our suppliers. Therefore prices are subject to change without notice. Please refer to our website for the most current pricing.