



Customer Change Notice

Type of Notice	<input type="checkbox"/> Change Approval Request <i>(customer signature required below)</i> <input checked="" type="checkbox"/> Change Notification Only <i>(no further action required by customer)</i>	
Customer:	AirLife Customer	
Date of Notice:	January 2, 2023	
Title of Change:	Robertazzi Style Latex Free Nasopharyngeal Airway Product Changes	
AirLife Change Request Number (DCR #)	DCR-13349	
Change Impact Assessment <i>(Select all impacted areas)</i>		
<input checked="" type="checkbox"/> Labeling	<input checked="" type="checkbox"/> Design	<input checked="" type="checkbox"/> Manufacturing Location Transfer
<input checked="" type="checkbox"/> Artwork	<input checked="" type="checkbox"/> Raw Material	<input type="checkbox"/> Manufacturing Process
<input checked="" type="checkbox"/> Packaging	<input type="checkbox"/> Product Configuration	<input checked="" type="checkbox"/> Tooling/Equipment
<input type="checkbox"/> Sterilization (Process/Documentation)	<input type="checkbox"/> Regulatory	<input type="checkbox"/> Quality System
<input type="checkbox"/> Other(<i>specify</i>): _____		
Description of Change		
The following changes will be implemented to the Robertazzi Style Latex Free Naso Airways: <ol style="list-style-type: none">1. Material change from neoprene to silicone2. Shelf-life change from 5 years to 4 years3. Minor dimensional changes to product4. Manufacturing location change5. Sterile pouch change to Tyvek pouch6. Box dimensional and artwork change7. Labelling updates Additional details on each change are provided below:		

1. Material change to silicone

Silicone has been deemed a superior material for airway products due to its stability in a large temperature range and non-stick properties. It is gentle on the airway during insertion, duration of use and removal. The appearance of the naso will not change drastically as a result of this material change. The SunMed logo directly printed onto the airway will change to AirLife.

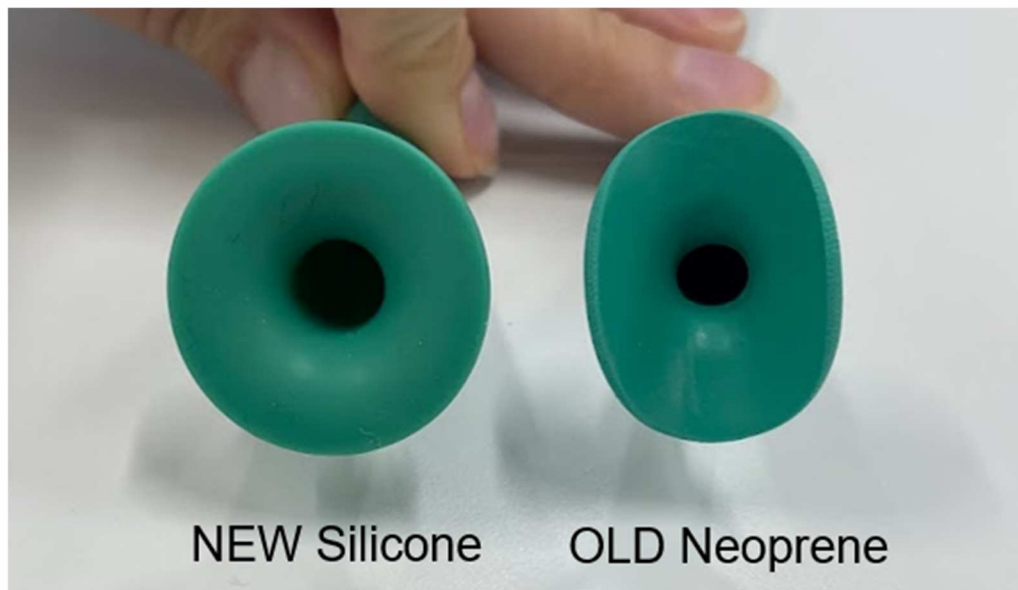
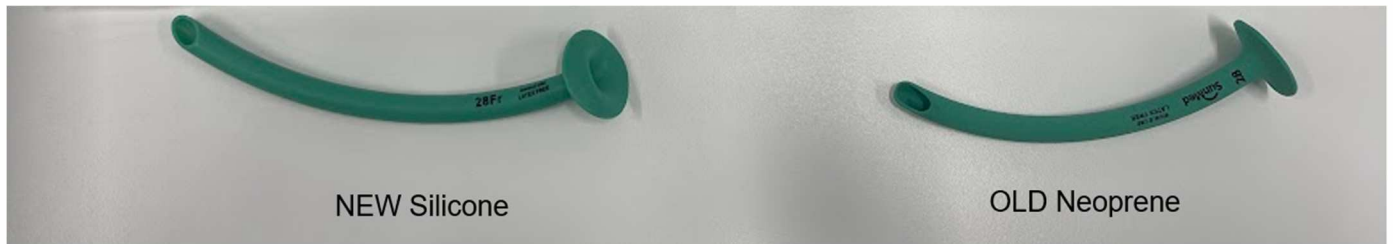

2. Shelf life decrease to 4 years

The silicone airway has currently been tested to a 4-year shelf life. This shelf life will be challenged to extend back up to 5 years, but the timing will extend past the initial release of the new airway. Labelling will reflect 4 years to start.

3. Minor dimensional changes

The new silicone naso molds will result in minor dimensional changes to each size of robertazzi airway. Dimensional changes are detailed in Table 1 below.

Table 1. Dimensional comparison of neoprene naso to new silicone naso.

Item Number	Size	Original Neoprene Naso			NEW Silicone Naso		
		Length (mm)	OD (mm)	ID (mm)	Length (±2 mm)	OD (±0.2 mm)	ID (±0.2 mm)
1-5075-20	20 Fr	114	6.4	3.9	120	6.7	5.0
1-5075-22	22 Fr	114	7.0	4.8	130	7.3	5.5
1-5075-24	24 Fr	120	7.8	5.3	135	8.0	6.0
1-5075-26	26 Fr	121	8.2	6.3	145	8.6	6.5
1-5075-28	28 Fr	132	9.1	6.8	150	9.3	7.0
1-5075-30	30 Fr	139	9.5	7.2	160	10.0	7.5
1-5075-32	32 Fr	146	10.2	7.6	175	10.7	8.0
1-5075-34	34 Fr	157	10.7	8.5	185	11.2	8.5
1-5075-36	36 Fr	170	11.6	9.0	190	12.0	9.0

4. Manufacturing location change

The manufacturing location is moving from India to China. Location of manufacturing site will be updated on the new labels.

5. Sterile pouch changing to Tyvek

The original opaque pouch will be updated to a Tyvek pouch (Tyvek paper on one side, clear plastic on the other) to ensure proper EO sterilization. Labelling updates to accommodate new pouch style will be detailed in a separate labelling customer change notice.



6. Box Dimensional and Artwork Updates

- The finished good box will be adjusted to best fit the new product in their new Tyvek pouches. Length will increase by 50mm. Height will increase by 25mm. Width will decrease by 35mm.
- Minor symbol updates (per current ISO standard)

Current box:

 FONTS: Myriad Family
 PMS 200

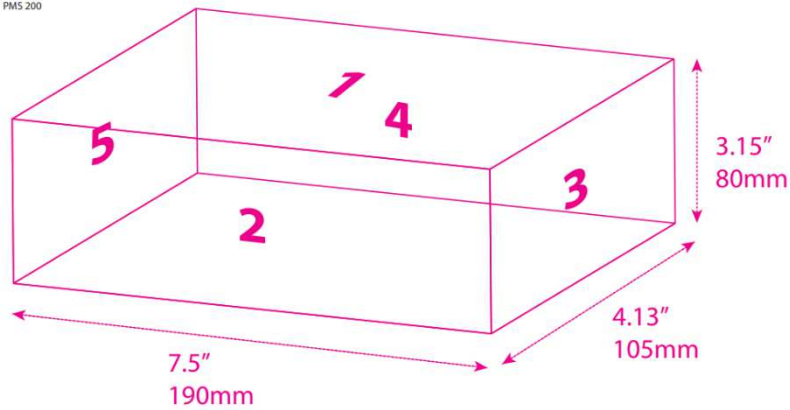

New box:

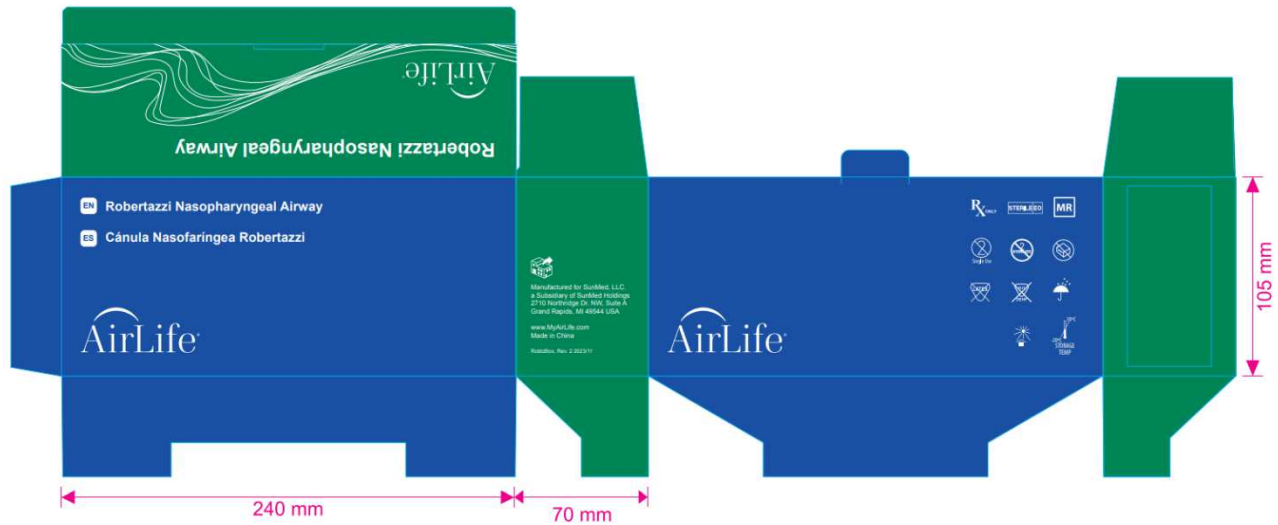



7. Labelling Updates

Labels are being updated to reflect product and manufacturing location changes. Label proofs are attached for your review.

Pouch artwork changes:

- Dimensional changes to fit new Tyvek pouch
- Added new silicone naso ID dimension.
- Shelf-life change from 5 to 4 years
- Updated symbols to match current ISO standard requirements
- Update barcode to QR code and print directly on pouch (instead of on extra sticker label)
- Adding “Made in China”
- SunMed logo is now AirLife

Current pouch artwork:

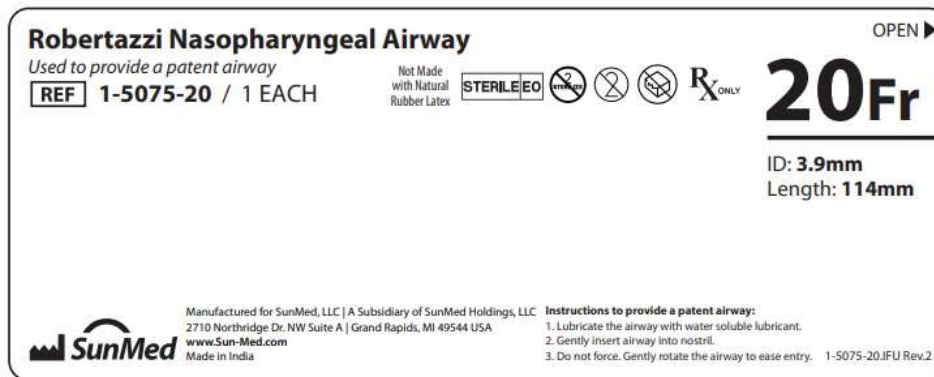

Current sticker barcode label:



New pouch artwork with incorporated QR code:

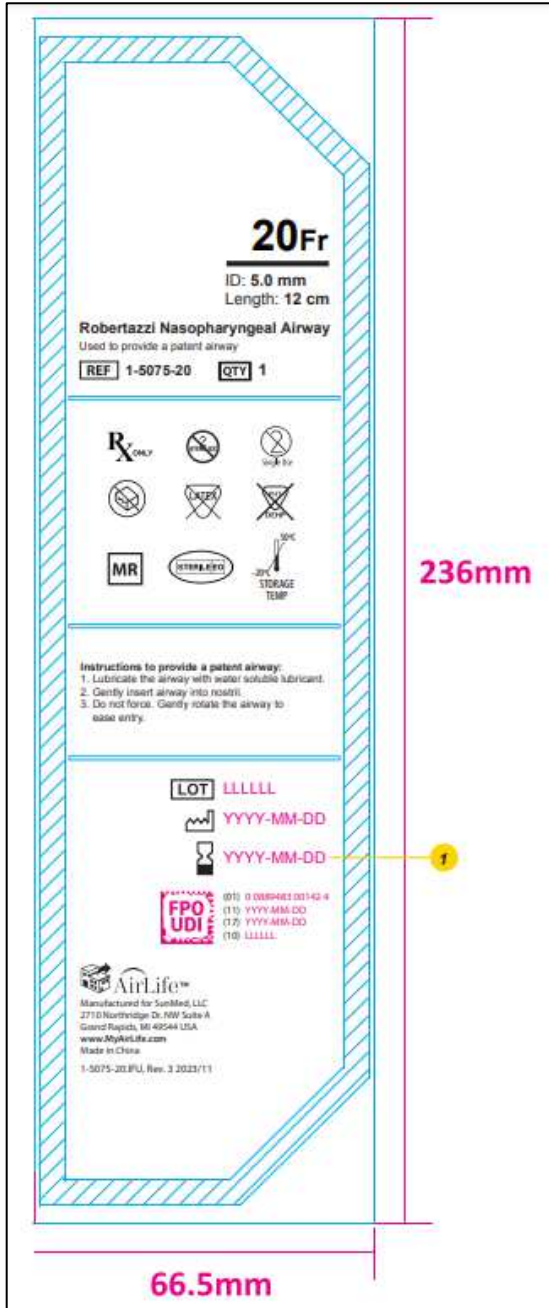

Box label changes:

- Added quantity symbol
- Added new ID/length

Current box Label:



New Case Label:

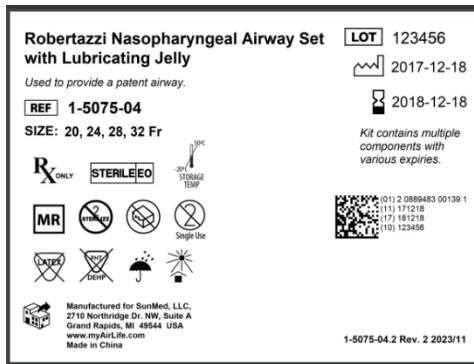

Impacted Part Numbers

Attachment

Part Number	Part Description
1-5075-04	LATEX FREE NASO 20 24 28 32FR
1-5075-05	LATEX FREE NASO 28FR THRU 36FR
1-5075-06	LATEX FREE NASO 22FR THRU 32FR
1-5075-09	LATEX FREE NASO 20FR THRU 36FR
1-5075-20	LATEX FREE NASO AIRWAY STERILE 20FR
1-5075-22	LATEX FREE NASO AIRWAY STERILE 22FR
1-5075-24	LATEX FREE NASO AIRWAY STERILE 24FR
1-5075-26	LATEX FREE NASO AIRWAY STERILE 26FR
1-5075-28	LATEX FREE NASO AIRWAY STERILE 28FR
1-5075-30	LATEX FREE NASO AIRWAY STERILE 30FR
1-5075-32	LATEX FREE NASO AIRWAY STERILE 32FR

Document #: FRM-10192
Revision #: 2

Toll Free 800.433.2797
T 616.259.8400
F 616.647.3430

www.myAirLife.com
2710 Northridge Dr NW, Ste. A
Grand Rapids, MI 49544



1-5075-34	LATEX FREE NASO AIRWAY STERILE 34FR
1-5075-36	LATEX FREE NASO AIRWAY STERILE 36FR

Reason/Justification for Change:

It was decided that the best decision would be to move away from the original neoprene material and transition to silicone (the industry standard for airways). Changing to silicone will result in these additional product and packaging improvements as well.

Impact On Form, Fit, Function, Quality, and Regulatory:

The overall intended use of the product will not change. Changes impacting regulatory registrations will be handled by the AirLife team.

Estimated Implementation Timeframe:

New product will arrive to AirLife facilities in April 2024.

AirLife Approvals

Originator	Name: Holly Lockwood	Signature: <i>Holly Lockwood</i>	Date: 1/11/2024
Engineering	Name: Kim Loda	Signature: <i>Kim Loda</i>	Date: 1/11/2024
Quality	Name: Leslie Dahman	Signature: <i>Leslie Dahman</i>	Date: 1/11/2024

Customer Approval

Customer's signature below gives AirLife formal approval to proceed with the changes listed above.

Name: N/A	Title: N/A	Company: N/A
Signature: N/A		Date: N/A



Approvals

Report • Printed on January 5, 2024

Approved

AirLife Robertazzi Naso Customer Change Notice

▼ Attachments



Robertazzi Nasos Customer Cf

<https://sunmedus-my.sharepoint.cor>

▼ Final status: Approved



Approved by
Leslie Dahmen

1/5/2024, 1:34:49 PM



Approved by
Kim Loda

1/2/2024, 11:25:40 AM



Approved by
Holly Lockwood

1/2/2024, 11:23:25 AM



Requested by
Holly Lockwood

1/2/2024, 11:23:10 AM

FOOTNOTES

BLUE line is a dieline and does not print.

PINK dotted line indicates where box label will be applied.

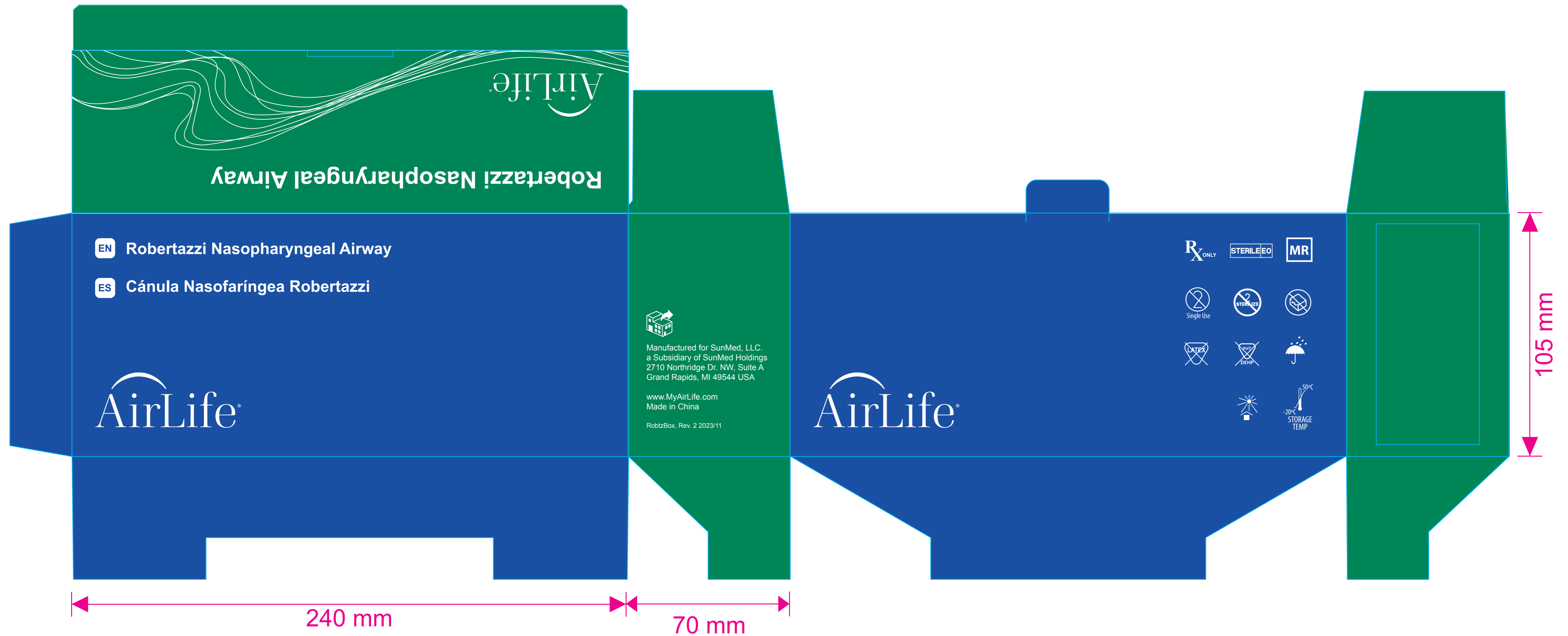

AirLife™ LABELING FILE SPECIFICATIONS	
AIRLIFE FG # <u>1-5075 Series</u>	CUSTOMER FG # _____
DCR# <u>13349</u>	RAW MATERIAL # _____
ARTWORK DESCRIPTION <u>Robertazzi Nasopharyngeal Airway Box</u>	
DIMENSIONS Flat: _____ Folded: <u>240 mm (W) x 105 mm (H) x 70 mm (D)</u>	
MATERIAL <input type="checkbox"/> Paper Insert <input type="checkbox"/> Printed Pouch <input checked="" type="checkbox"/> Printed Box <input type="checkbox"/> Pad Printing <input type="checkbox"/> Label <input type="checkbox"/> Other _____	
INK COLOR(S) <input type="checkbox"/> [Blank] Ink <input checked="" type="checkbox"/> PMS 2728 C <input checked="" type="checkbox"/> PMS 7725 C	
PRINTING INFORMATION Printer: _____ Print Method: _____	
DOC CONTROL # <u>RobtzBox</u>	REVISION # <u>2</u>
GRAPHIC DESIGNER <u>Chelsea Luehrs</u>	DATE <u>11/06/2023</u>

FOOTNOTES

PINK text is a placeholder and does not print

1 Shelf Life is 4 Years

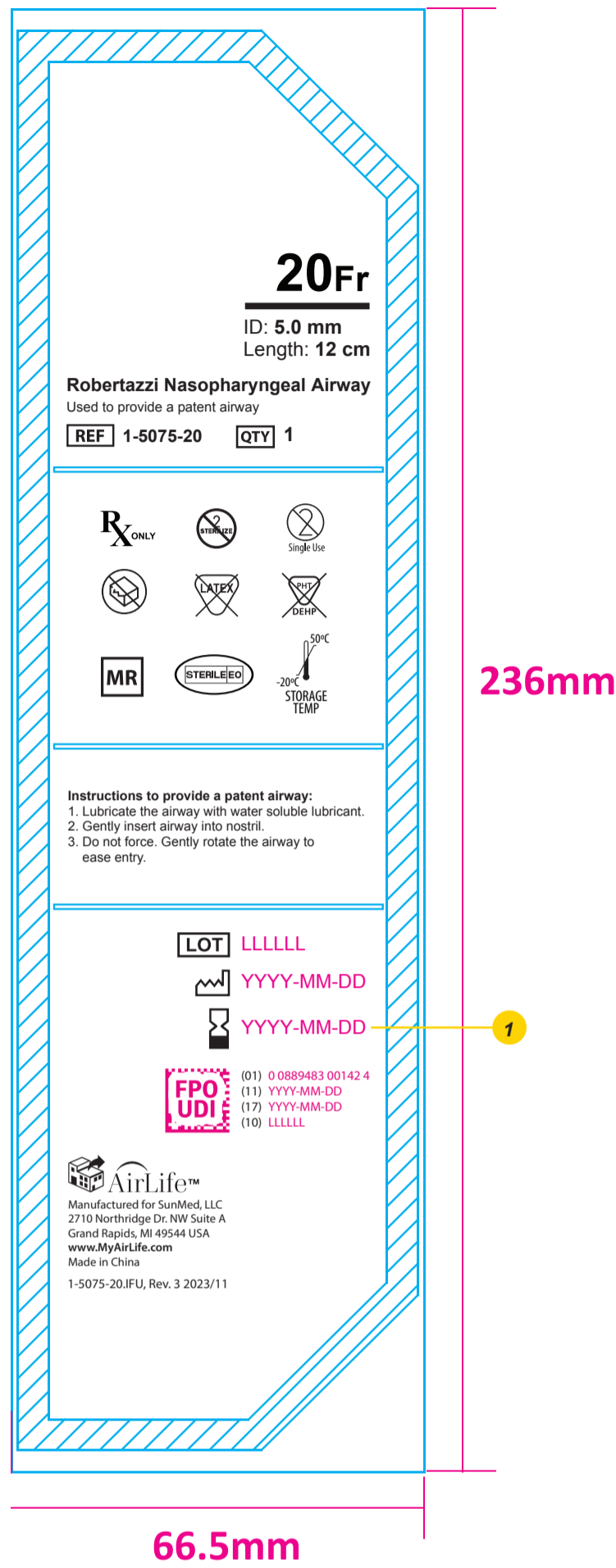

AirLife™ LABELING FILE SPECIFICATIONS	
AIRLIFE FG # <u>1-5075-20</u>	CUSTOMER FG # _____
DCR# <u>13349</u>	RAW MATERIAL # _____
ARTWORK DESCRIPTION <u>Robertazzi Nasopharyngeal Airway Size 20</u>	
DIMENSIONS Flat: <u>66.5 mm (W) x 236 mm (H)</u> Folded: <u>N/A</u>	
MATERIAL <input type="checkbox"/> Paper Insert <input checked="" type="checkbox"/> Printed Pouch <input type="checkbox"/> Printed Box <input type="checkbox"/> Pad Printing <input type="checkbox"/> Label <input type="checkbox"/> Other _____	
INK COLOR(S) <input checked="" type="checkbox"/> Black Ink	
PRINTING INFORMATION Printer: _____ Print Method: <u>Imprint</u>	
DOC CONTROL # <u>1-5075-20.IFU</u>	REVISION # <u>3</u>
GRAPHIC DESIGNER <u>Chelsea Luehrs</u>	DATE <u>11/01/2023</u>

FOOTNOTES

PINK text is a placeholder and does not print

1 Shelf Life is 4 Years

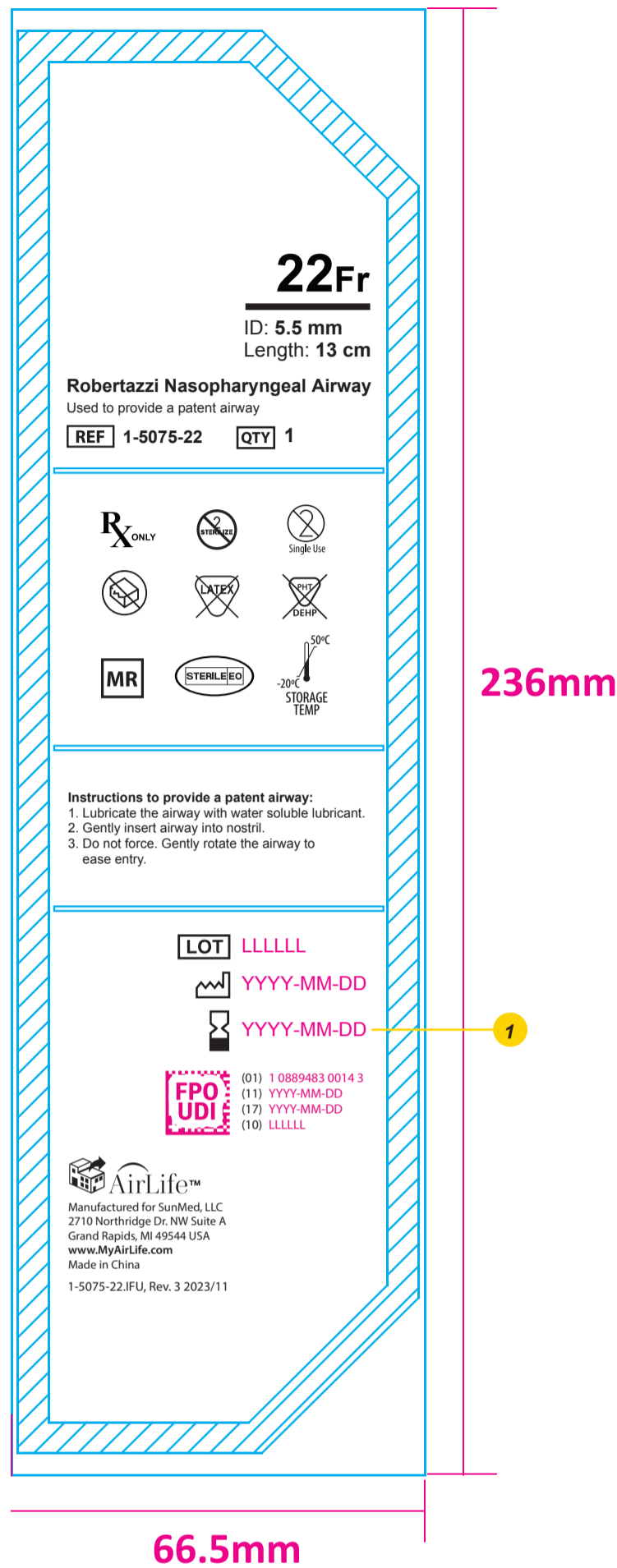

AirLife™ LABELING FILE SPECIFICATIONS	
AIRLIFE FG # <u>1-5075-22</u>	CUSTOMER FG # _____
DCR# <u>13349</u>	RAW MATERIAL # _____
ARTWORK DESCRIPTION <u>Robertazzi Nasopharyngeal Airway Size 22</u>	
DIMENSIONS Flat: <u>66.5 mm (W) x 236 mm (H)</u> Folded: <u>N/A</u>	
MATERIAL <input type="checkbox"/> Paper Insert <input checked="" type="checkbox"/> Printed Pouch <input type="checkbox"/> Printed Box <input type="checkbox"/> Pad Printing <input type="checkbox"/> Label <input type="checkbox"/> Other _____	
INK COLOR(S) <input checked="" type="checkbox"/> Black Ink	
PRINTING INFORMATION Printer: _____ Print Method: <u>Imprint</u>	
DOC CONTROL # <u>1-5075-22.IFU</u>	REVISION # <u>3</u>
GRAPHIC DESIGNER <u>Chelsea Luehrs</u>	DATE <u>11/01/2023</u>

FOOTNOTES

PINK text is a placeholder and does not print

1 Shelf Life is 4 Years

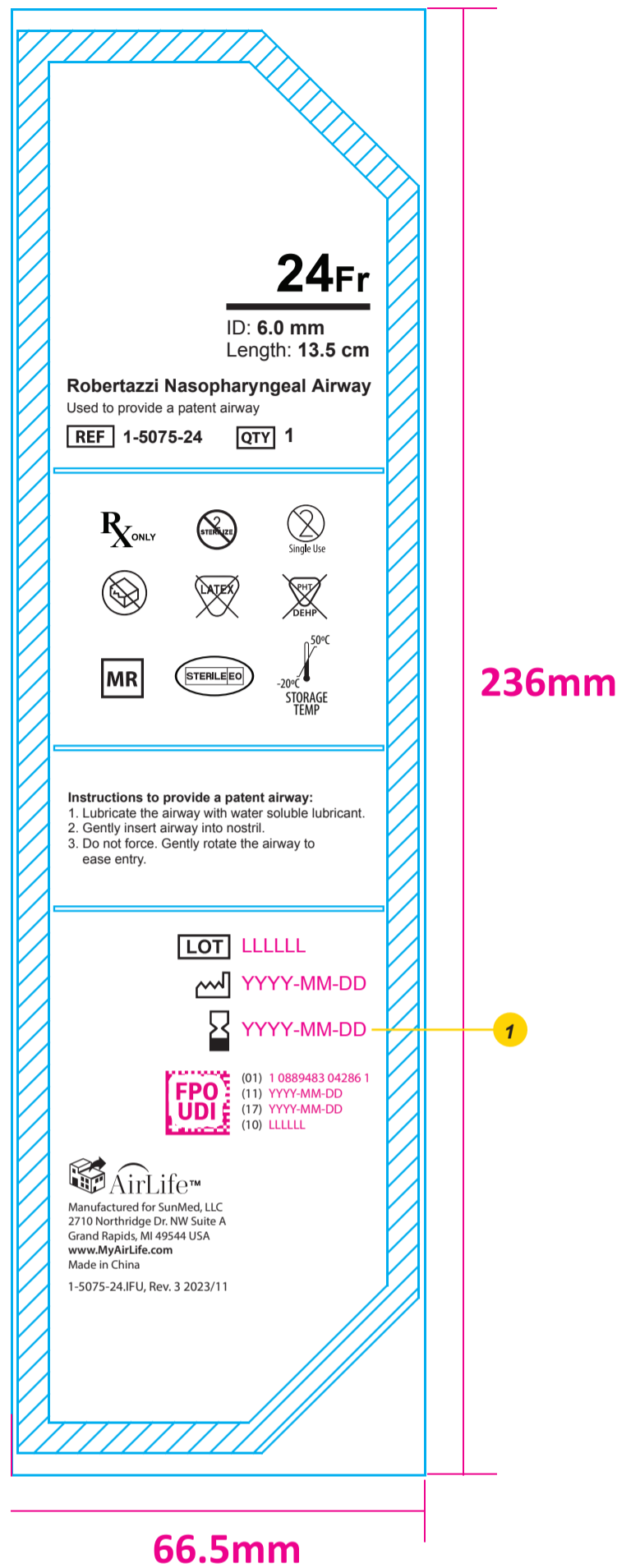

AirLife™ LABELING FILE SPECIFICATIONS	
AIRLIFE FG # <u>1-5075-24</u>	CUSTOMER FG # _____
DCR# <u>13349</u>	RAW MATERIAL # _____
ARTWORK DESCRIPTION Robertazzi Nasopharyngeal Airway Size 24	
DIMENSIONS Flat: <u>66.5 mm (W) x 236 mm (H)</u> Folded: <u>N/A</u>	
MATERIAL <input type="checkbox"/> Paper Insert <input checked="" type="checkbox"/> Printed Pouch <input type="checkbox"/> Printed Box <input type="checkbox"/> Pad Printing <input type="checkbox"/> Label <input type="checkbox"/> Other _____	
INK COLOR(S) <input checked="" type="checkbox"/> Black Ink	
PRINTING INFORMATION Printer: _____ Print Method: <u>Imprint</u>	
DOC CONTROL # <u>1-5075-24:IFU</u>	REVISION # <u>3</u>
GRAPHIC DESIGNER <u>Chelsea Luehrs</u>	DATE <u>11/01/2023</u>

FOOTNOTES

PINK text is a placeholder and does not print

1 Shelf Life is 4 Years

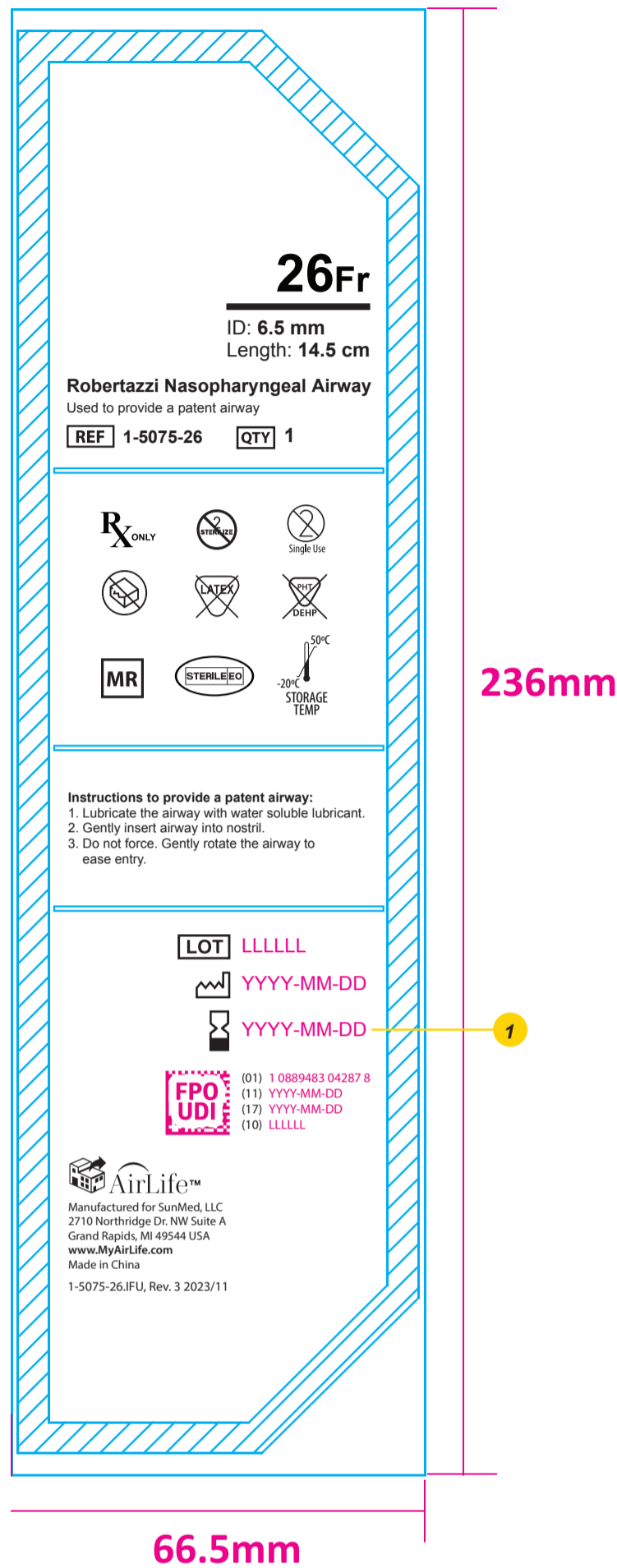

AirLife™ LABELING FILE SPECIFICATIONS	
AIRLIFE FG # <u>1-5075-26</u>	CUSTOMER FG # _____
DCR# <u>13349</u>	RAW MATERIAL # _____
ARTWORK DESCRIPTION <u>Robertazzi Nasopharyngeal Airway Size 26</u>	
DIMENSIONS Flat: <u>66.5 mm (W) x 236 mm (H)</u> Folded: <u>N/A</u>	
MATERIAL <input type="checkbox"/> Paper Insert <input checked="" type="checkbox"/> Printed Pouch <input type="checkbox"/> Printed Box <input type="checkbox"/> Pad Printing <input type="checkbox"/> Label <input type="checkbox"/> Other _____	
INK COLOR(S) <input checked="" type="checkbox"/> Black Ink	
PRINTING INFORMATION Printer: _____ Print Method: <u>Imprint</u>	
DOC CONTROL # <u>1-5075-26.IFU</u>	REVISION # <u>3</u>
GRAPHIC DESIGNER <u>Chelsea Luehrs</u>	DATE <u>11/01/2023</u>

FOOTNOTES

PINK text is a placeholder and does not print

1 Shelf Life is 4 Years

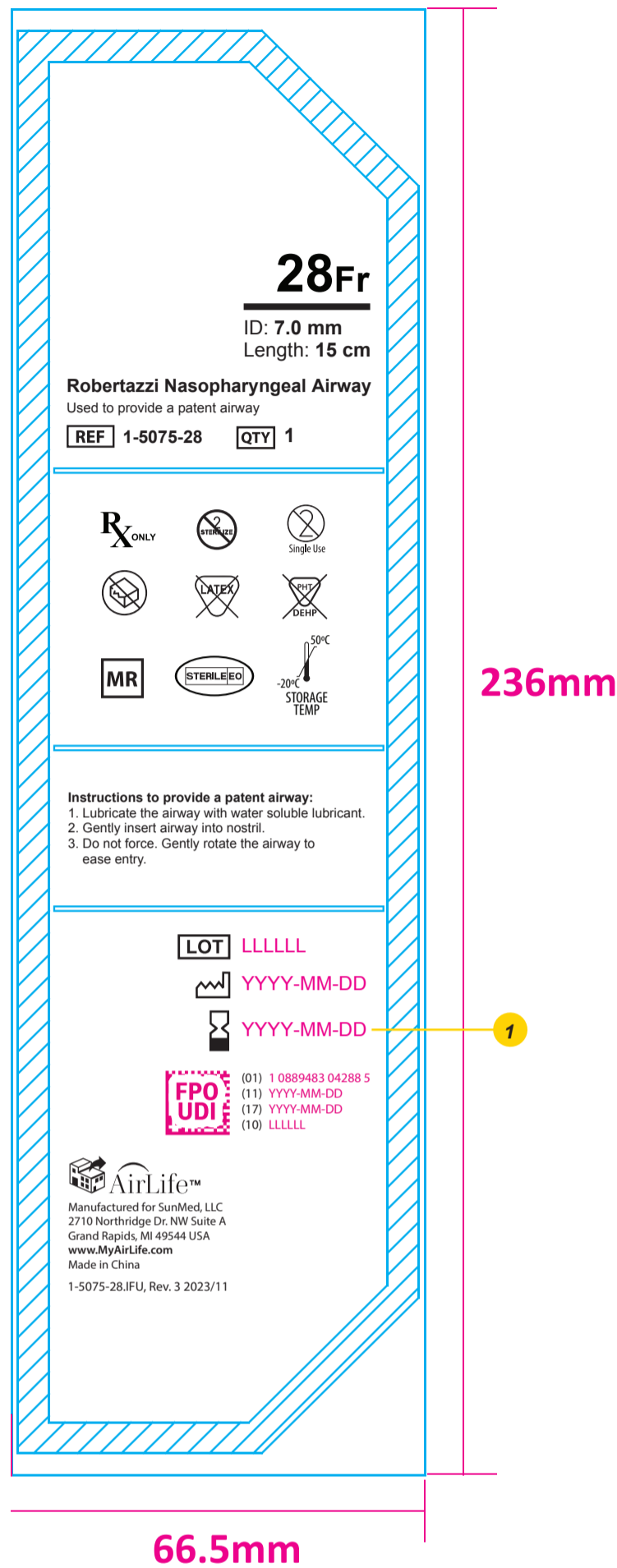

AirLife™ LABELING FILE SPECIFICATIONS	
AIRLIFE FG # <u>1-5075-28</u>	CUSTOMER FG # _____
DCR# <u>13349</u>	RAW MATERIAL # _____
ARTWORK DESCRIPTION <u>Robertazzi Nasopharyngeal Airway Size 28</u>	
DIMENSIONS Flat: <u>66.5 mm (W) x 236 mm (H)</u> Folded: <u>N/A</u>	
MATERIAL <input type="checkbox"/> Paper Insert <input checked="" type="checkbox"/> Printed Pouch <input type="checkbox"/> Printed Box <input type="checkbox"/> Pad Printing <input type="checkbox"/> Label <input type="checkbox"/> Other _____	
INK COLOR(S) <input checked="" type="checkbox"/> Black Ink	
PRINTING INFORMATION Printer: _____ Print Method: <u>Imprint</u>	
DOC CONTROL # <u>1-5075-28.IFU</u>	REVISION # <u>3</u>
GRAPHIC DESIGNER <u>Chelsea Luehrs</u>	DATE <u>11/01/2023</u>

FOOTNOTES

PINK text is a placeholder and does not print

1 Shelf Life is 4 Years

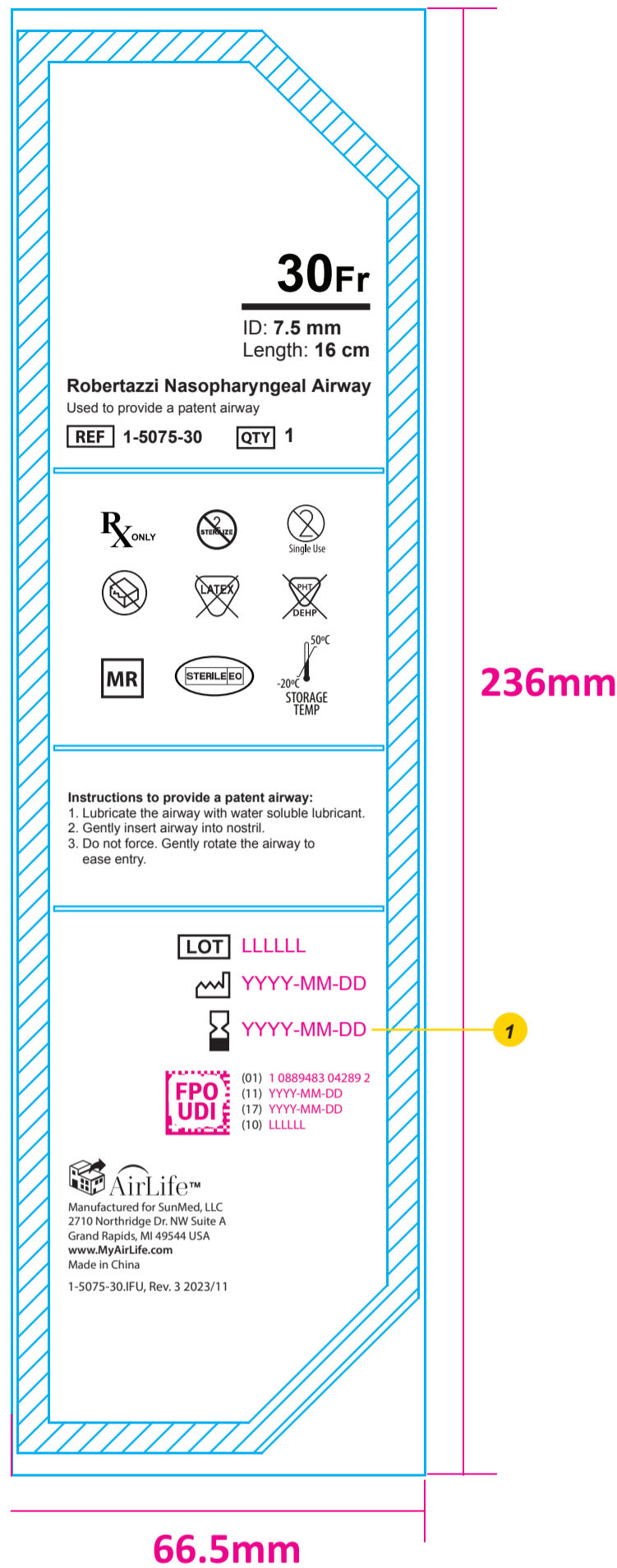

 LABELING FILE SPECIFICATIONS	
AIRLIFE FG # <u>1-5075-30</u>	CUSTOMER FG # _____
DCR# <u>13349</u>	RAW MATERIAL # _____
ARTWORK DESCRIPTION Robertazzi Nasopharyngeal Airway Size 30	
DIMENSIONS Flat: <u>66.5 mm (W) x 236 mm (H)</u> Folded: <u>N/A</u>	
MATERIAL <input type="checkbox"/> Paper Insert <input checked="" type="checkbox"/> Printed Pouch <input type="checkbox"/> Printed Box <input type="checkbox"/> Pad Printing <input type="checkbox"/> Label <input type="checkbox"/> Other _____	
INK COLOR(S) <input checked="" type="checkbox"/> Black Ink	
PRINTING INFORMATION Printer: _____ Print Method: <u>Imprint</u>	
DOC CONTROL # <u>1-5075-30.IFU</u>	REVISION # <u>3</u>
GRAPHIC DESIGNER <u>Chelsea Luehrs</u>	DATE <u>11/01/2023</u>

FOOTNOTES

PINK text is a placeholder and does not print

1 Shelf Life is 4 Years

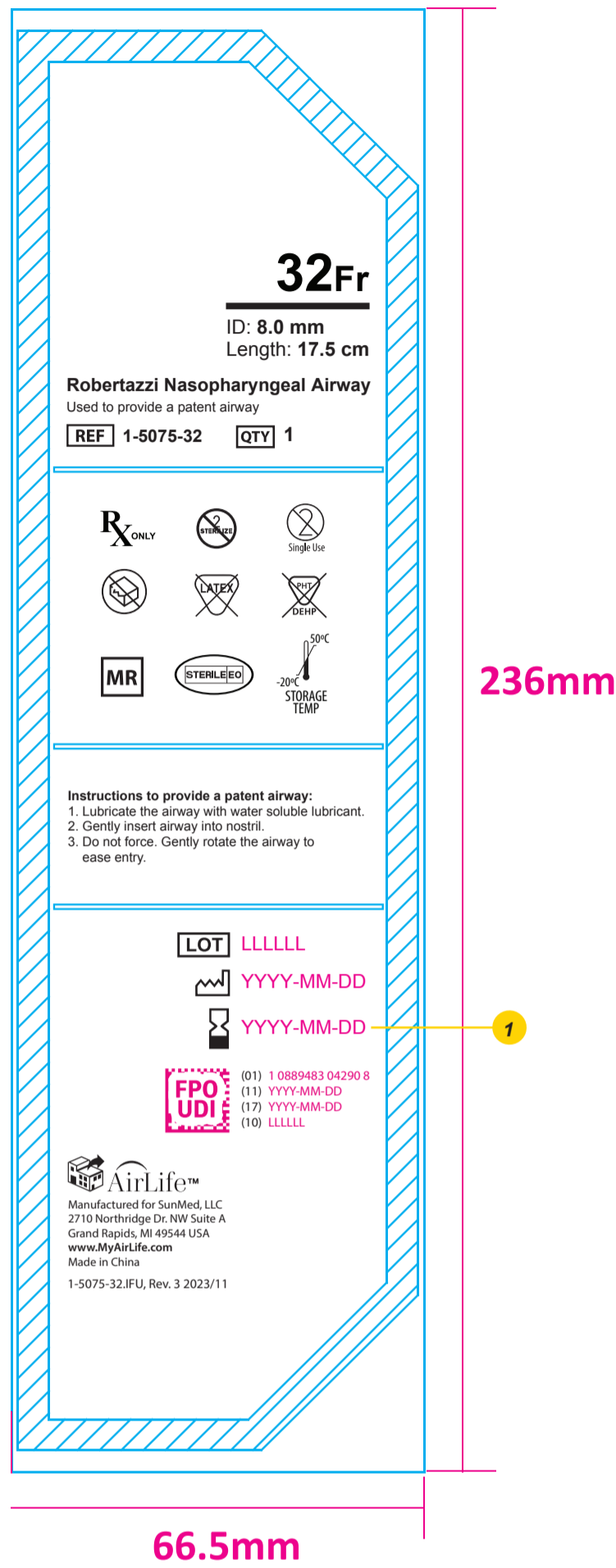

AirLife™ LABELING FILE SPECIFICATIONS	
AIRLIFE FG # <u>1-5075-32</u>	CUSTOMER FG # _____
DCR# <u>13349</u>	RAW MATERIAL # _____
ARTWORK DESCRIPTION <u>Robertazzi Nasopharyngeal Airway Size 32</u>	
DIMENSIONS Flat: <u>66.5 mm (W) x 236 mm (H)</u> Folded: <u>N/A</u>	
MATERIAL <input type="checkbox"/> Paper Insert <input checked="" type="checkbox"/> Printed Pouch <input type="checkbox"/> Printed Box <input type="checkbox"/> Pad Printing <input type="checkbox"/> Label <input type="checkbox"/> Other _____	
INK COLOR(S) <input checked="" type="checkbox"/> Black Ink	
PRINTING INFORMATION Printer: _____ Print Method: <u>Imprint</u>	
DOC CONTROL # <u>1-5075-32.IFU</u>	REVISION # <u>3</u>
GRAPHIC DESIGNER <u>Chelsea Luehrs</u>	DATE <u>11/01/2023</u>

FOOTNOTES

PINK text is a placeholder and does not print

1 Shelf Life is 4 Years

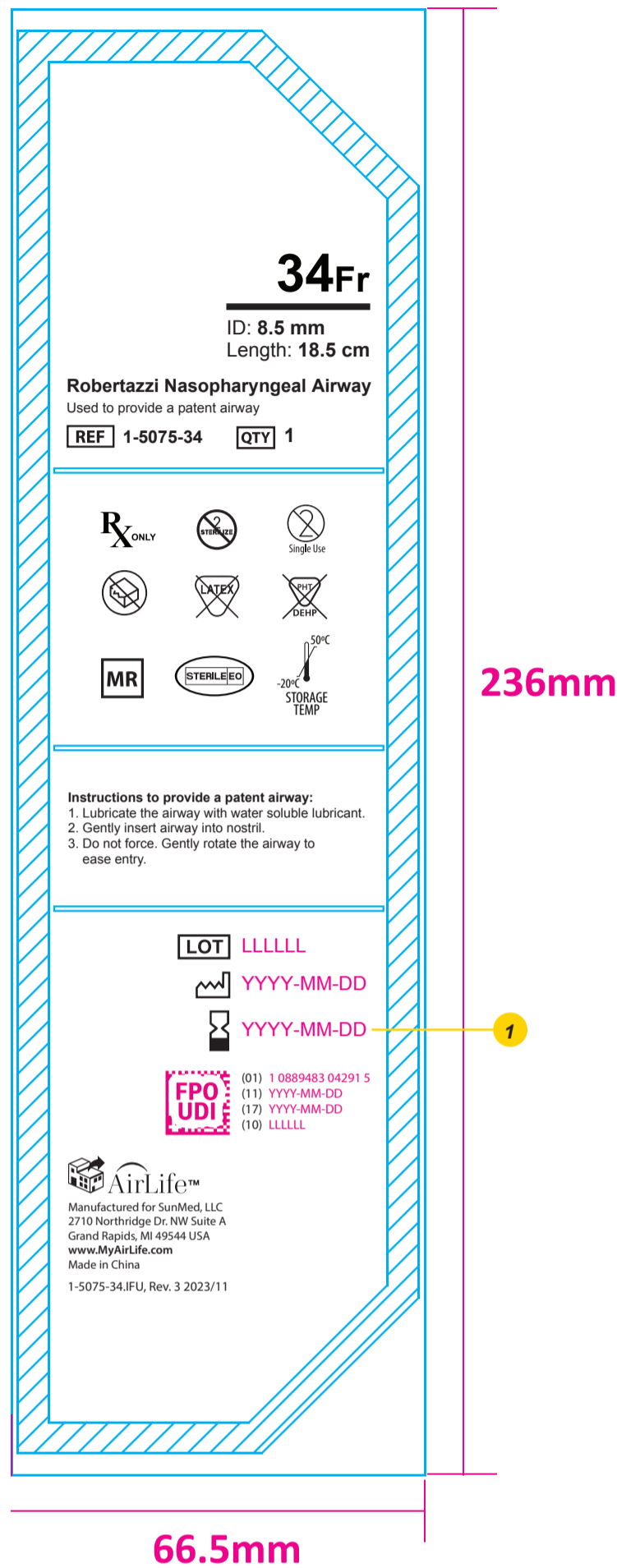

AirLife™ LABELING FILE SPECIFICATIONS	
AIRLIFE FG # <u>1-5075-34</u>	CUSTOMER FG # _____
DCR# <u>13349</u>	RAW MATERIAL # _____
ARTWORK DESCRIPTION <u>Robertazzi Nasopharyngeal Airway Size 234</u>	
DIMENSIONS Flat: <u>66.5 mm (W) x 236 mm (H)</u> Folded: <u>N/A</u>	
MATERIAL <input type="checkbox"/> Paper Insert <input checked="" type="checkbox"/> Printed Pouch <input type="checkbox"/> Printed Box <input type="checkbox"/> Pad Printing <input type="checkbox"/> Label <input type="checkbox"/> Other _____	
INK COLOR(S) <input checked="" type="checkbox"/> Black Ink	
PRINTING INFORMATION Printer: _____ Print Method: <u>Imprint</u>	
DOC CONTROL # <u>1-5075-34.IFU</u>	REVISION # <u>3</u>
GRAPHIC DESIGNER <u>Chelsea Luehrs</u>	DATE <u>11/01/2023</u>

FOOTNOTES

PINK text is a placeholder and does not print

1 Shelf Life is 4 Years

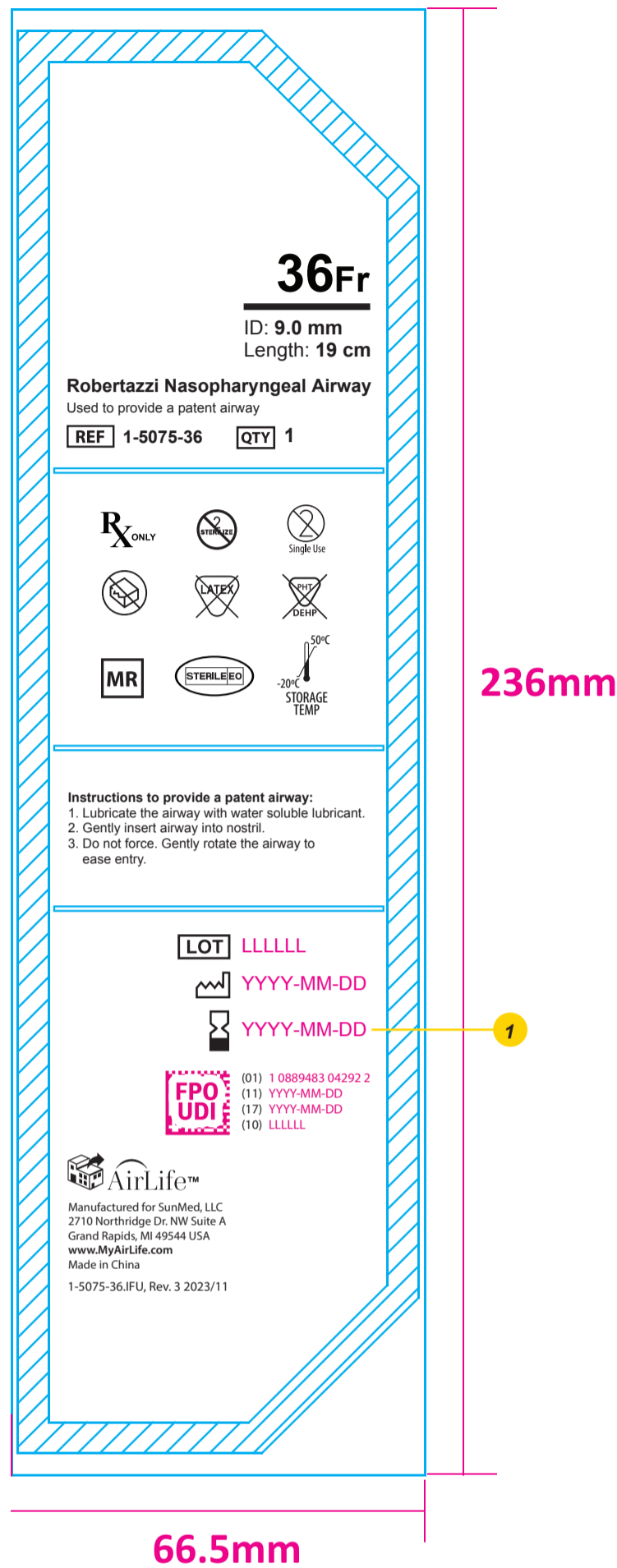

AirLife™ LABELING FILE SPECIFICATIONS	
AIRLIFE FG # <u>1-5075-36</u>	CUSTOMER FG # _____
DCR# <u>13349</u>	RAW MATERIAL # _____
ARTWORK DESCRIPTION <u>Robertazzi Nasopharyngeal Airway Size 36</u>	
DIMENSIONS Flat: <u>66.5 mm (W) x 236 mm (H)</u> Folded: <u>N/A</u>	
MATERIAL <input type="checkbox"/> Paper Insert <input checked="" type="checkbox"/> Printed Pouch <input type="checkbox"/> Printed Box <input type="checkbox"/> Pad Printing <input type="checkbox"/> Label <input type="checkbox"/> Other _____	
INK COLOR(S) <input checked="" type="checkbox"/> Black Ink	
PRINTING INFORMATION Printer: _____ Print Method: <u>Imprint</u>	
DOC CONTROL # <u>1-5075-36.IFU</u>	REVISION # <u>3</u>
GRAPHIC DESIGNER <u>Chelsea Luehrs</u>	DATE <u>11/01/2023</u>

Robertazzi Nasopharyngeal Airway Set with Lubricating Jelly

Used to provide a patent airway.

REF 1-5075-04

SIZE: 20, 24, 28, 32 Fr

R_X ONLY

STERILE EO

50°C
-20°C
STORAGE
TEMP

MR

~~STERILIZE~~



~~2~~
Single Use

~~LATEX~~

~~PHT
DEHP~~



Manufactured for SunMed, LLC,
2710 Northridge Dr. NW, Suite A
Grand Rapids, MI 49544 USA
www.myAirLife.com
Made in China

LOT 123456

 2017-12-18

 2018-12-18

*Kit contains multiple
components with
various expiries.*



(01) 2 0889483 00139 1
(11) 171218
(17) 181218
(10) 123456

1-5075-04.2 Rev. 2 2023/11

Robertazzi Nasopharyngeal Airway Set with Lubricating Jelly

Used to provide a patent airway.

REF 1-5075-05

SIZE: 28, 30, 32, 34, 36 Fr

R_X ONLY

STERILE EO

50°C
-20°C
STORAGE
TEMP

MR

~~STERILIZE~~



~~2~~
Single Use

~~LATEX~~

~~PHT
DEHP~~



Manufactured for SunMed, LLC,
2710 Northridge Dr. NW, Suite A
Grand Rapids, MI 49544 USA
www.myAirLife.com
Made in China

LOT 123456

 2017-12-18

 2018-12-18

*Kit contains multiple
components with
various expiries.*



(01) 2 0889483 22821 7
(11) 171218
(17) 181218
(10) 123456

1-5075-05.2 Rev. 2 2023/11

Robertazzi Nasopharyngeal Airway Set with Lubricating Jelly

Used to provide a patent airway.

REF 1-5075-06

SIZE: 22, 24, 26, 28, 30, 32 Fr

R_X ONLY

STERILE EO

50°C
-20°C
STORAGE
TEMP

MR

~~STERILIZE~~



~~2~~
Single Use

~~LATEX~~

~~PHT
DEHP~~



Manufactured for SunMed, LLC,
2710 Northridge Dr. NW, Suite A
Grand Rapids, MI 49544 USA
www.myAirLife.com
Made in China

LOT 123456

 2017-12-18

 2018-12-18

*Kit contains multiple
components with
various expiries.*



(01) 2 0889483 00140 7
(11) 171218
(17) 181218
(10) 123456

1-5075-06.2 Rev. 2 2023/11

Robertazzi Nasopharyngeal Airway Set with Lubricating Jelly

Used to provide a patent airway

REF 1-5075-09

SIZE: 20, 22, 24, 26, 28, 30, 32, 34 & 36Fr

R_X ONLY

STERILE EO

50°C
-20°C
STORAGE
TEMP

MR

~~STERILIZE~~



~~2~~
Single Use

~~LATEX~~

~~PHT
DEHP~~



Manufactured for SunMed, LLC,
2710 Northridge Dr. NW, Suite A
Grand Rapids, MI 49544 USA
www.myAirLife.com
Made in China

LOT 123456

 2017-12-18

 2018-12-18

*Kit contains multiple
components with
various expiries.*



(01) 2 0889483 00141 4
(11) 171218
(17) 181218
(10) 123456

1-5075-09.2 Rev. 3 2023/11

FOOTNOTES

Pink text is a placeholder for variable information added by supplier.

- 1** 3.75 (W) x 1.75 (H) label placed on printed box: RobtzBox (symbols printed on box art)
- 2** Shelf life is 4 years.

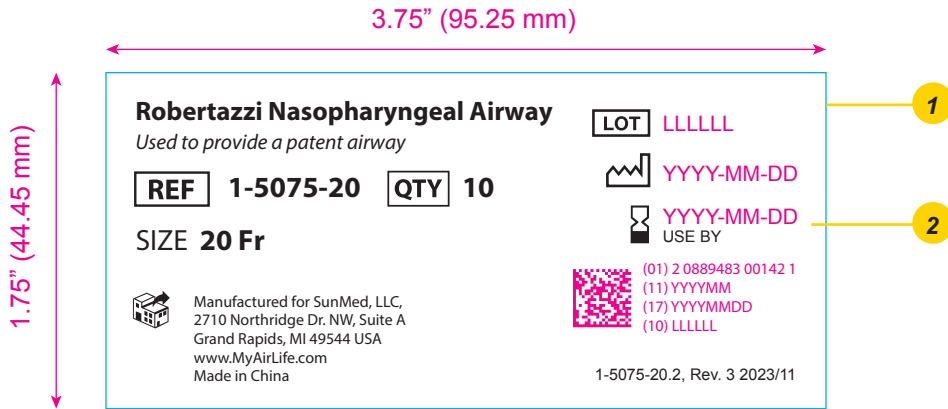

	LABELING FILE SPECIFICATIONS
AIRLIFE FG # <u>1-5075-20</u>	CUSTOMER FG # _____
DCR# <u>13349</u>	RAW MATERIAL # _____
ARTWORK DESCRIPTION <u>1-5075-20.2, Box Label - Robertazzi Nasopharyngeal Airway Size 20 Fr</u>	
DIMENSIONS Flat: <u>3.75" (W) x 1.5" (H) \ 95.25 mm (W) x 44.45 mm (H)</u> Folded: <u>N/A</u>	
MATERIAL <input type="checkbox"/> Paper Insert <input type="checkbox"/> Printed Pouch <input type="checkbox"/> Printed Box <input type="checkbox"/> Pad Printing <input checked="" type="checkbox"/> Label <input type="checkbox"/> Other _____	
INK COLOR(S) ■ Black Ink	
PRINTING INFORMATION Printer: _____ Print Method: _____	
DOC CONTROL # <u>1-5075-20.2</u>	
REVISION # <u>3</u>	
GRAPHIC DESIGNER <u>Chelsea Luehrs</u>	
DATE <u>11/06/2023</u>	

FOOTNOTES

Pink text is a placeholder for variable information added by supplier.

- 1 3.75 (W) x 1.75 (H) label placed on printed box: 2021-181Box (symbols printed on box art)
- 2 Shelf life is 4 years.

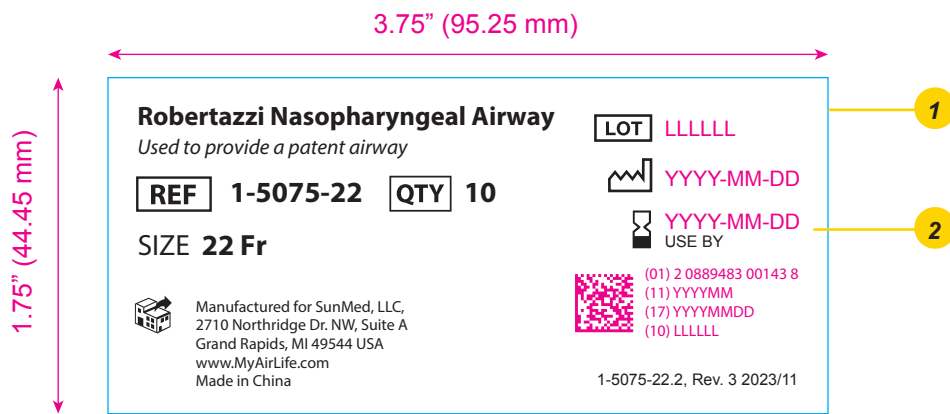

AirLife™	LABELING FILE SPECIFICATIONS	
AIRLIFE FG # <u>1-5075-22</u>	CUSTOMER FG # _____	
DCR# <u>13349</u>	RAW MATERIAL # _____	
ARTWORK DESCRIPTION <u>1-5075-22.2, Box Label - Robertazzi Nasopharyngeal Airway Size 22 Fr</u>		
DIMENSIONS Flat: <u>3.75" (W) x 1.5" (H) \ 95.25 mm (W) x 44.45 mm (H)</u> Folded: <u>N/A</u>		
MATERIAL <input type="checkbox"/> Paper Insert <input type="checkbox"/> Printed Pouch <input type="checkbox"/> Printed Box <input type="checkbox"/> Pad Printing <input checked="" type="checkbox"/> Label <input type="checkbox"/> Other _____		
INK COLOR(S) <input checked="" type="checkbox"/> Black Ink		
PRINTING INFORMATION Printer: _____ Print Method: _____		
DOC CONTROL # <u>1-5075-22.2</u>		REVISION # <u>3</u>
GRAPHIC DESIGNER <u>Chelsea Luehrs</u>		DATE <u>11/06/2023</u>

FOOTNOTES

Pink text is a placeholder for variable information added by supplier.

- 1 3.75 (W) x 1.75 (H) label placed on printed box: 2021-181Box (symbols printed on box art)
- 2 Shelf life is 4 years.

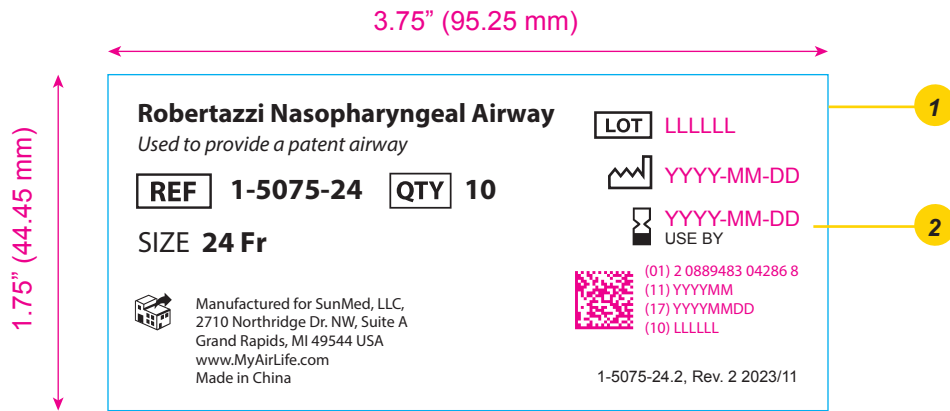

	LABELING FILE SPECIFICATIONS
AIRLIFE FG # <u>1-5075-24</u> CUSTOMER FG # _____	
DCR# <u>13349</u> RAW MATERIAL # _____	
ARTWORK DESCRIPTION <u>1-5075-24.2, Box Label - Robertazzi Nasopharyngeal Airway Size 24 Fr</u>	
DIMENSIONS Flat: <u>3.75" (W) x 1.5" (H) \ 95.25 mm (W) x 44.45 mm (H)</u> Folded: <u>N/A</u>	
MATERIAL <input type="checkbox"/> Paper Insert <input type="checkbox"/> Printed Pouch <input type="checkbox"/> Printed Box <input type="checkbox"/> Pad Printing <input checked="" type="checkbox"/> Label <input type="checkbox"/> Other _____	
INK COLOR(S) ■ Black Ink	
PRINTING INFORMATION Printer: _____ Print Method: _____	
DOC CONTROL # <u>1-5075-24.2</u> REVISION # <u>2</u>	
GRAPHIC DESIGNER <u>Chelsea Luehrs</u> DATE <u>11/06/2023</u>	

FOOTNOTES

Pink text is a placeholder for variable information added by supplier.

- 1 3.75 (W) x 1.75 (H) label placed on printed box: 2021-181Box (symbols printed on box art)
- 2 Shelf life is 4 years.

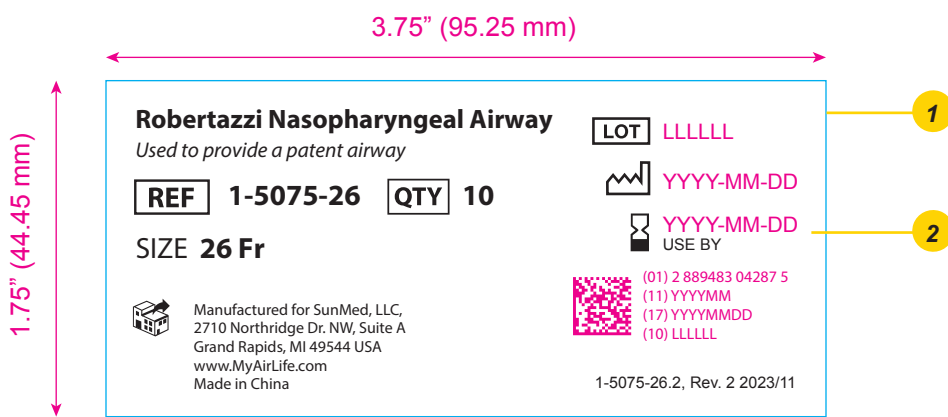

	LABELING FILE SPECIFICATIONS
AIRLIFE FG # <u>1-5075-26</u>	CUSTOMER FG # _____
DCR# <u>13349</u>	RAW MATERIAL # _____
ARTWORK DESCRIPTION <u>1-5075-26.2, Box Label - Robertazzi Nasopharyngeal Airway Size 26 Fr</u>	
DIMENSIONS Flat: <u>3.75" (W) x 1.5" (H) \ 95.25 mm (W) x 44.45 mm (H)</u> Folded: <u>N/A</u>	
MATERIAL <input type="checkbox"/> Paper Insert <input type="checkbox"/> Printed Pouch <input type="checkbox"/> Printed Box <input type="checkbox"/> Pad Printing <input checked="" type="checkbox"/> Label <input type="checkbox"/> Other _____	
INK COLOR(S) ■ Black Ink	
PRINTING INFORMATION Printer: _____ Print Method: _____	
DOC CONTROL # <u>1-5075-26.2</u>	
REVISION # <u>2</u>	
GRAPHIC DESIGNER <u>Chelsea Luehrs</u>	
DATE <u>11/06/2023</u>	

FOOTNOTES

Pink text is a placeholder for variable information added by supplier.

- 1** 3.75 (W) x 1.75 (H) label placed on printed box: 2021-181Box (symbols printed on box art)
- 2** Shelf life is 4 years.

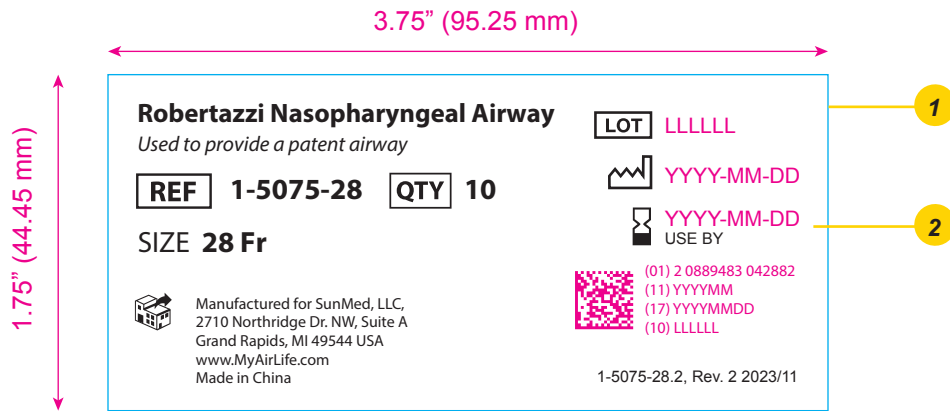

	LABELING FILE SPECIFICATIONS
AIRLIFE FG # <u>1-5075-28</u>	CUSTOMER FG # _____
DCR# <u>13349</u>	RAW MATERIAL # _____
ARTWORK DESCRIPTION <u>1-5075-28.2, Box Label - Robertazzi Nasopharyngeal Airway Size 28 Fr</u>	
DIMENSIONS Flat: <u>3.75" (W) x 1.5" (H) \ 95.25 mm (W) x 44.45 mm (H)</u> Folded: <u>N/A</u>	
MATERIAL <input type="checkbox"/> Paper Insert <input type="checkbox"/> Printed Pouch <input type="checkbox"/> Printed Box <input type="checkbox"/> Pad Printing <input checked="" type="checkbox"/> Label <input type="checkbox"/> Other _____	
INK COLOR(S) ■ Black Ink	
PRINTING INFORMATION Printer: _____ Print Method: _____	
DOC CONTROL # <u>1-5075-28.2</u>	
REVISION # <u>2</u>	
GRAPHIC DESIGNER <u>Chelsea Luehrs</u>	
DATE <u>11/06/2023</u>	

FOOTNOTES

Pink text is a placeholder for variable information added by supplier.

- 1 3.75 (W) x 1.75 (H) label placed on printed box: 2021-181Box (symbols printed on box art)
- 2 Shelf life is 4 years.

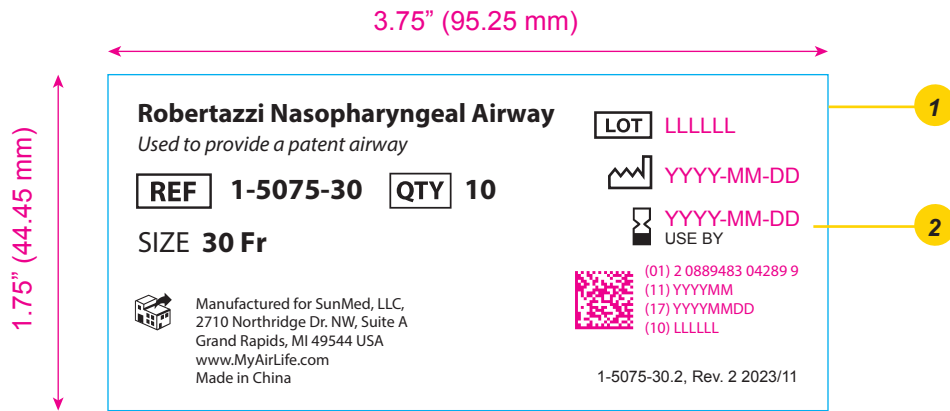

	LABELING FILE SPECIFICATIONS
AIRLIFE FG # <u>1-5075-30</u> CUSTOMER FG # _____	
DCR# <u>13349</u> RAW MATERIAL # _____	
ARTWORK DESCRIPTION <u>1-5075-30.2, Box Label - Robertazzi Nasopharyngeal Airway Size 302 Fr</u>	
DIMENSIONS Flat: <u>3.75" (W) x 1.5" (H) \ 95.25 mm (W) x 44.45 mm (H)</u> Folded: <u>N/A</u>	
MATERIAL <input type="checkbox"/> Paper Insert <input type="checkbox"/> Printed Pouch <input type="checkbox"/> Printed Box <input type="checkbox"/> Pad Printing <input checked="" type="checkbox"/> Label <input type="checkbox"/> Other _____	
INK COLOR(S) ■ Black Ink	
PRINTING INFORMATION Printer: _____ Print Method: _____	
DOC CONTROL # <u>1-5075-30.2</u> REVISION # <u>2</u>	
GRAPHIC DESIGNER <u>Chelsea Luehrs</u> DATE <u>11/06/2023</u>	

FOOTNOTES

Pink text is a placeholder for variable information added by supplier.

- 1 3.75 (W) x 1.75 (H) label placed on printed box: 2021-181Box (symbols printed on box art)
- 2 Shelf life is 4 years.

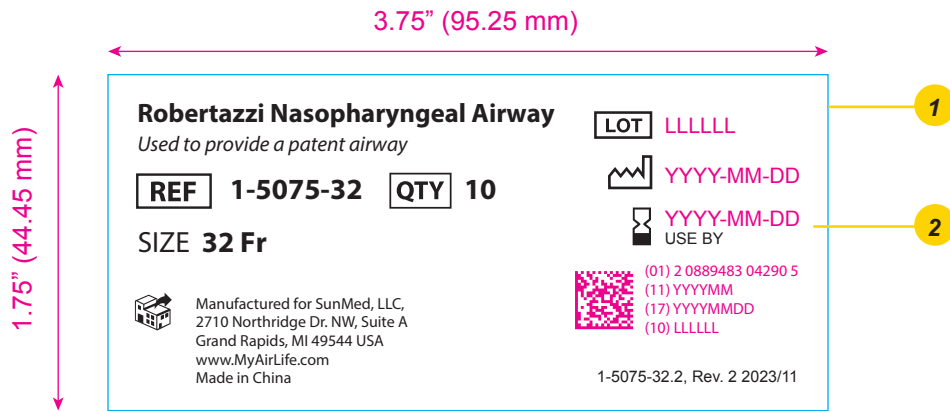

	LABELING FILE SPECIFICATIONS
AIRLIFE FG # <u>1-5075-32</u>	CUSTOMER FG # _____
DCR# <u>13349</u>	RAW MATERIAL # _____
ARTWORK DESCRIPTION <u>1-5075-32.2, Box Label - Robertazzi Nasopharyngeal Airway Size 32 Fr</u>	
DIMENSIONS Flat: <u>3.75" (W) x 1.5" (H) \ 95.25 mm (W) x 44.45 mm (H)</u> Folded: <u>N/A</u>	
MATERIAL <input type="checkbox"/> Paper Insert <input type="checkbox"/> Printed Pouch <input type="checkbox"/> Printed Box <input type="checkbox"/> Pad Printing <input checked="" type="checkbox"/> Label <input type="checkbox"/> Other _____	
INK COLOR(S) ■ Black Ink	
PRINTING INFORMATION Printer: _____ Print Method: _____	
DOC CONTROL # <u>1-5075-32.2</u>	
REVISION # <u>2</u>	
GRAPHIC DESIGNER <u>Chelsea Luehrs</u>	
DATE <u>11/06/2023</u>	

FOOTNOTES

Pink text is a placeholder for variable information added by supplier.

- 1 3.75 (W) x 1.75 (H) label placed on printed box: 2021-181Box (symbols printed on box art)
- 2 Shelf life is 4 years.

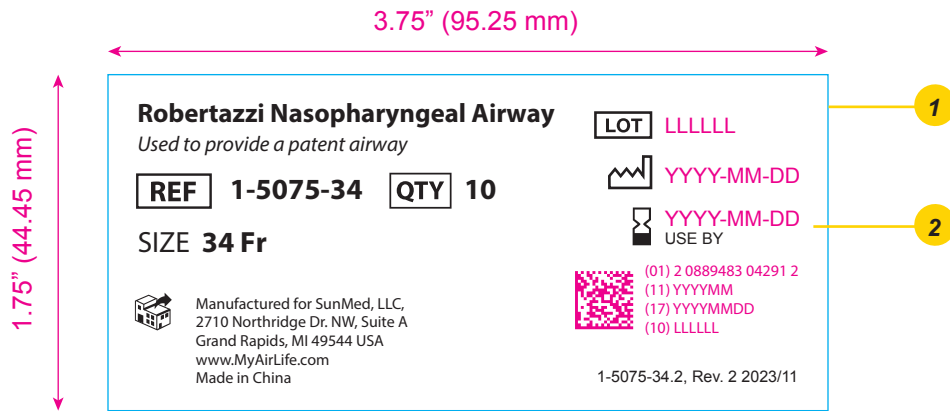

	LABELING FILE SPECIFICATIONS
AIRLIFE FG # <u>1-5075-34</u> CUSTOMER FG # _____	
DCR# <u>13349</u> RAW MATERIAL # _____	
ARTWORK DESCRIPTION <u>1-5075-34.2, Box Label - Robertazzi Nasopharyngeal Airway Size 34 Fr</u>	
DIMENSIONS Flat: <u>3.75" (W) x 1.5" (H) \ 95.25 mm (W) x 44.45 mm (H)</u> Folded: <u>N/A</u>	
MATERIAL <input type="checkbox"/> Paper Insert <input type="checkbox"/> Printed Pouch <input type="checkbox"/> Printed Box <input type="checkbox"/> Pad Printing <input checked="" type="checkbox"/> Label <input type="checkbox"/> Other _____	
INK COLOR(S) ■ Black Ink	
PRINTING INFORMATION Printer: _____ Print Method: _____	
DOC CONTROL # <u>1-5075-34.2</u> REVISION # <u>2</u>	
GRAPHIC DESIGNER <u>Chelsea Luehrs</u> DATE <u>11/06/2023</u>	

FOOTNOTES

Pink text is a placeholder for variable information added by supplier.

- 1 3.75 (W) x 1.75 (H) label placed on printed box: 2021-181Box (symbols printed on box art)
- 2 Shelf life is 4 years.

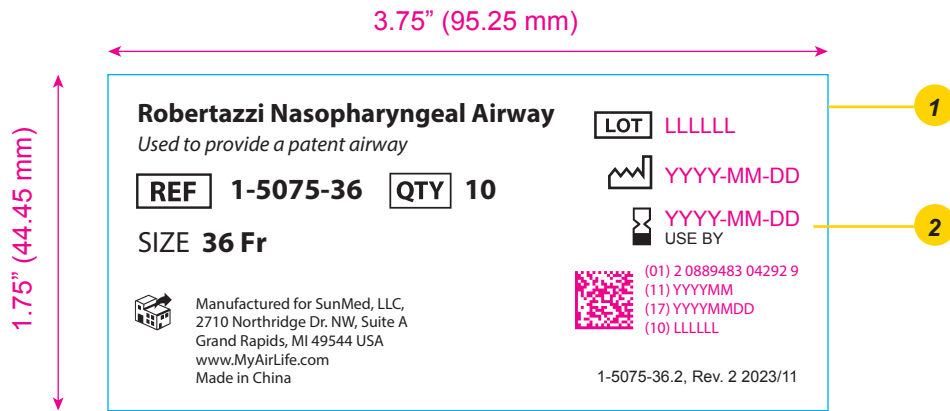

	LABELING FILE SPECIFICATIONS
AIRLIFE FG # <u>1-5075-36</u>	CUSTOMER FG # _____
DCR# <u>13349</u>	RAW MATERIAL # _____
ARTWORK DESCRIPTION <u>1-5075-36.2, Box Label - Robertazzi Nasopharyngeal Airway Size 36 Fr</u>	
DIMENSIONS Flat: <u>3.75" (W) x 1.5" (H) \ 95.25 mm (W) x 44.45 mm (H)</u> Folded: <u>N/A</u>	
MATERIAL <input type="checkbox"/> Paper Insert <input type="checkbox"/> Printed Pouch <input type="checkbox"/> Printed Box <input type="checkbox"/> Pad Printing <input checked="" type="checkbox"/> Label <input type="checkbox"/> Other _____	
INK COLOR(S) ■ Black Ink	
PRINTING INFORMATION Printer: _____ Print Method: _____	
DOC CONTROL # <u>1-5075-36.2</u>	
REVISION # <u>2</u>	
GRAPHIC DESIGNER <u>Chelsea Luehrs</u>	
DATE <u>11/06/2023</u>	

Robertazzi Nasopharyngeal Airway Set with Lubricating Jelly

Used to provide a patent airway.

REF 1-5075-04

SIZE: 20, 24, 28, 32 Fr

R_x ONLY

STERILE EO

50°C
-20°C
STORAGE
TEMP

MR

~~STERILIZE~~



~~2~~
Single Use

~~LATEX~~

~~PHT
DEHP~~



Manufactured for SunMed, LLC,
2710 Northridge Dr. NW, Suite A
Grand Rapids, MI 49544 USA
www.myAirLife.com
Made in China

LOT 123456

 2017-12-18

 2018-12-18

*Kit contains multiple
components with
various expiries.*



(01) 2 0889483 00139 1
(11) 171218
(17) 181218
(10) 123456

1-5075-04.2 Rev. 2 2023/11

Robertazzi Nasopharyngeal Airway Set with Lubricating Jelly

Used to provide a patent airway.

REF 1-5075-05

SIZE: 28, 30, 32, 34, 36 Fr

R_X ONLY

STERILE EO

50°C
-20°C
STORAGE
TEMP

MR

~~STERILIZE~~



~~2~~
Single Use

~~LATEX~~

~~PHT
DEHP~~



Manufactured for SunMed, LLC,
2710 Northridge Dr. NW, Suite A
Grand Rapids, MI 49544 USA
www.myAirLife.com
Made in China

LOT 123456

 2017-12-18

 2018-12-18

*Kit contains multiple
components with
various expiries.*



(01) 2 0889483 22821 7
(11) 171218
(17) 181218
(10) 123456

1-5075-05.2 Rev. 2 2023/11

Robertazzi Nasopharyngeal Airway Set with Lubricating Jelly

Used to provide a patent airway.

REF 1-5075-06

SIZE: 22, 24, 26, 28, 30, 32 Fr

R_X ONLY

STERILE EO

50°C
-20°C
STORAGE
TEMP

MR

~~STERILIZE~~



~~2~~
Single Use

~~LATEX~~

~~PHT
DEHP~~



Manufactured for SunMed, LLC,
2710 Northridge Dr. NW, Suite A
Grand Rapids, MI 49544 USA
www.myAirLife.com
Made in China

LOT 123456

 2017-12-18

 2018-12-18

*Kit contains multiple
components with
various expiries.*



(01) 2 0889483 00140 7
(11) 171218
(17) 181218
(10) 123456

1-5075-06.2 Rev. 2 2023/11

Robertazzi Nasopharyngeal Airway Set with Lubricating Jelly

Used to provide a patent airway

REF 1-5075-09

SIZE: 20, 22, 24, 26, 28, 30, 32, 34 & 36Fr

R_X ONLY

STERILE EO

50°C
-20°C
STORAGE
TEMP

MR

~~2~~
STERILIZE



~~2~~
Single Use

~~LATEX~~

~~PHT
DEHP~~



Manufactured for SunMed, LLC,
2710 Northridge Dr. NW, Suite A
Grand Rapids, MI 49544 USA
www.myAirLife.com
Made in China

LOT 123456

 2017-12-18

 2018-12-18

*Kit contains multiple
components with
various expiries.*



(01) 2 0889483 00141 4
(11) 171218
(17) 181218
(10) 123456

1-5075-09.2 Rev. 3 2023/11

FOOTNOTES

BLUE line does not print



AirLife™ LABELING FILE SPECIFICATIONS	
AIRLIFE FG # <u>1-5075-20</u>	CUSTOMER FG # _____
DCR# <u>13349</u>	RAW MATERIAL # _____
ARTWORK DESCRIPTION <u>Robertazzi Nasopharyngeal Airway Size 20</u>	
DIMENSIONS Flat: <u>66.5 mm (W) x 236 mm (H)</u> Folded: <u>N/A</u>	
MATERIAL <input type="checkbox"/> Paper Insert <input type="checkbox"/> Printed Pouch <input type="checkbox"/> Printed Box <input type="checkbox"/> Pad Printing <input type="checkbox"/> Label <input checked="" type="checkbox"/> Other <u>Product Imprint</u>	
INK COLOR(S) <input checked="" type="checkbox"/> Black Ink	
PRINTING INFORMATION Printer: _____ Print Method: <u>Imprint</u>	
DOC CONTROL # <u>1-5075-20.0</u>	REVISION # <u>1</u>
GRAPHIC DESIGNER <u>Chelsea Luehrs</u>	DATE <u>11/01/2023</u>

FOOTNOTES

BLUE line does not print



	LABELING FILE SPECIFICATIONS
AIRLIFE FG # <u>1-5075-22</u>	CUSTOMER FG # _____
DCR# <u>13349</u>	RAW MATERIAL # _____
ARTWORK DESCRIPTION <u>Robertazzi Nasopharyngeal Airway Size 22</u>	
DIMENSIONS Flat: <u>66.5 mm (W) x 236 mm (H)</u> Folded: <u>N/A</u>	
MATERIAL <input type="checkbox"/> Paper Insert <input type="checkbox"/> Printed Pouch <input type="checkbox"/> Printed Box <input type="checkbox"/> Pad Printing <input type="checkbox"/> Label <input checked="" type="checkbox"/> Other <u>Product Imprint</u>	
INK COLOR(S) <input checked="" type="checkbox"/> Black Ink	
PRINTING INFORMATION Printer: _____ Print Method: <u>Imprint</u>	
DOC CONTROL # <u>1-5075-22.0</u>	REVISION # <u>1</u>
GRAPHIC DESIGNER <u>Chelsea Luehrs</u>	DATE <u>11/01/2023</u>

FOOTNOTES

BLUE line does not print



AirLife™ LABELING FILE SPECIFICATIONS	
AIRLIFE FG # <u>1-5075-24</u>	CUSTOMER FG # _____
DCR# <u>13349</u>	RAW MATERIAL # _____
ARTWORK DESCRIPTION <u>Robertazzi Nasopharyngeal Airway Size 24</u>	
DIMENSIONS Flat: <u>66.5 mm (W) x 236 mm (H)</u> Folded: <u>N/A</u>	
MATERIAL <input type="checkbox"/> Paper Insert <input type="checkbox"/> Printed Pouch <input type="checkbox"/> Printed Box <input type="checkbox"/> Pad Printing <input type="checkbox"/> Label <input checked="" type="checkbox"/> Other <u>Product Imprint</u>	
INK COLOR(S) <input checked="" type="checkbox"/> Black Ink	
PRINTING INFORMATION Printer: _____ Print Method: <u>Imprint</u>	
DOC CONTROL # <u>1-5075-24.0</u>	REVISION # <u>1</u>
GRAPHIC DESIGNER <u>Chelsea Luehrs</u>	DATE <u>11/01/2023</u>

FOOTNOTES

BLUE line does not print



AirLife™ LABELING FILE SPECIFICATIONS	
AIRLIFE FG # <u>1-5075-26</u>	CUSTOMER FG # _____
DCR# <u>13349</u>	RAW MATERIAL # _____
ARTWORK DESCRIPTION <u>Robertazzi Nasopharyngeal Airway Size 26</u>	
DIMENSIONS Flat: <u>66.5 mm (W) x 236 mm (H)</u> Folded: <u>N/A</u>	
MATERIAL <input type="checkbox"/> Paper Insert <input type="checkbox"/> Printed Pouch <input type="checkbox"/> Printed Box <input type="checkbox"/> Pad Printing <input type="checkbox"/> Label <input checked="" type="checkbox"/> Other <u>Product Imprint</u>	
INK COLOR(S) <input checked="" type="checkbox"/> Black Ink	
PRINTING INFORMATION Printer: _____ Print Method: <u>Imprint</u>	
DOC CONTROL # <u>1-5075-26.0</u>	REVISION # <u>1</u>
GRAPHIC DESIGNER <u>Chelsea Luehrs</u>	DATE <u>11/01/2023</u>

FOOTNOTES

BLUE line does not print



	LABELING FILE SPECIFICATIONS
AIRLIFE FG # <u>1-5075-28</u>	CUSTOMER FG # _____
DCR# <u>13349</u>	RAW MATERIAL # _____
ARTWORK DESCRIPTION <u>Robertazzi Nasopharyngeal Airway Size 28</u>	
DIMENSIONS Flat: <u>66.5 mm (W) x 236 mm (H)</u> Folded: <u>N/A</u>	
MATERIAL <input type="checkbox"/> Paper Insert <input type="checkbox"/> Printed Pouch <input type="checkbox"/> Printed Box <input type="checkbox"/> Pad Printing <input type="checkbox"/> Label <input checked="" type="checkbox"/> Other <u>Product Imprint</u>	
INK COLOR(S) <input checked="" type="checkbox"/> Black Ink	
PRINTING INFORMATION Printer: _____ Print Method: <u>Imprint</u>	
DOC CONTROL # <u>1-5075-28.0</u>	REVISION # <u>1</u>
GRAPHIC DESIGNER <u>Chelsea Luehrs</u>	DATE <u>11/01/2023</u>

FOOTNOTES

BLUE line does not print



AirLife™ LABELING FILE SPECIFICATIONS	
AIRLIFE FG # <u>1-5075-30</u>	CUSTOMER FG # _____
DCR# <u>13349</u>	RAW MATERIAL # _____
ARTWORK DESCRIPTION <u>Robertazzi Nasopharyngeal Airway Size 30</u>	
DIMENSIONS Flat: <u>66.5 mm (W) x 236 mm (H)</u> Folded: <u>N/A</u>	
MATERIAL <input type="checkbox"/> Paper Insert <input type="checkbox"/> Printed Pouch <input type="checkbox"/> Printed Box <input type="checkbox"/> Pad Printing <input type="checkbox"/> Label <input checked="" type="checkbox"/> Other <u>Product Imprint</u>	
INK COLOR(S) <input checked="" type="checkbox"/> Black Ink	
PRINTING INFORMATION Printer: _____ Print Method: <u>Imprint</u>	
DOC CONTROL # <u>1-5075-30.0</u>	REVISION # <u>1</u>
GRAPHIC DESIGNER <u>Chelsea Luehrs</u>	DATE <u>11/01/2023</u>

FOOTNOTES

BLUE line does not print



AirLife™ LABELING FILE SPECIFICATIONS	
AIRLIFE FG # <u>1-5075-32</u>	CUSTOMER FG # _____
DCR# <u>13349</u>	RAW MATERIAL # _____
ARTWORK DESCRIPTION <u>Robertazzi Nasopharyngeal Airway Size 32</u>	
DIMENSIONS Flat: <u>66.5 mm (W) x 236 mm (H)</u> Folded: <u>N/A</u>	
MATERIAL <input type="checkbox"/> Paper Insert <input type="checkbox"/> Printed Pouch <input type="checkbox"/> Printed Box <input type="checkbox"/> Pad Printing <input type="checkbox"/> Label <input checked="" type="checkbox"/> Other <u>Product Imprint</u>	
INK COLOR(S) <input checked="" type="checkbox"/> Black Ink	
PRINTING INFORMATION Printer: _____ Print Method: <u>Imprint</u>	
DOC CONTROL # <u>1-5075-32.0</u>	REVISION # <u>1</u>
GRAPHIC DESIGNER <u>Chelsea Luehrs</u>	DATE <u>11/01/2023</u>

FOOTNOTES

BLUE line does not print



		LABELING FILE SPECIFICATIONS	
AIRLIFE FG #	<u>1-5075-34</u>	CUSTOMER FG #	_____
DCR#	<u>13349</u>	RAW MATERIAL #	_____
ARTWORK DESCRIPTION <u>Robertazzi Nasopharygeal Airway Size 34</u>			
DIMENSIONS Flat: <u>66.5 mm (W) x 236 mm (H)</u> Folded: <u>N/A</u>			
MATERIAL <input type="checkbox"/> Paper Insert <input type="checkbox"/> Printed Pouch <input type="checkbox"/> Printed Box <input type="checkbox"/> Pad Printing <input type="checkbox"/> Label <input checked="" type="checkbox"/> Other <u>Product Imprint</u>			
INK COLOR(S) <input checked="" type="checkbox"/> Black Ink			
PRINTING INFORMATION Printer: _____ Print Method: <u>Imprint</u>			
DOC CONTROL #	<u>1-5075-34.0</u>	REVISION #	<u>1</u>
GRAPHIC DESIGNER	<u>Chelsea Luehrs</u>	DATE	<u>11/01/2023</u>

FOOTNOTES

BLUE line does not print



		LABELING FILE SPECIFICATIONS	
AIRLIFE FG #	<u>1-5075-36</u>	CUSTOMER FG #	_____
DCR#	<u>13349</u>	RAW MATERIAL #	_____
ARTWORK DESCRIPTION <u>Robertazzi Nasopharyngeal Airway Size 36</u>			
DIMENSIONS Flat: <u>66.5 mm (W) x 236 mm (H)</u> Folded: <u>N/A</u>			
MATERIAL <input type="checkbox"/> Paper Insert <input type="checkbox"/> Printed Pouch <input type="checkbox"/> Printed Box <input type="checkbox"/> Pad Printing <input type="checkbox"/> Label <input checked="" type="checkbox"/> Other <u>Product Imprint</u>			
INK COLOR(S) <input checked="" type="checkbox"/> Black Ink			
PRINTING INFORMATION Printer: _____ Print Method: <u>Imprint</u>			
DOC CONTROL #	<u>1-5075-36.0</u>	REVISION #	<u>1</u>
GRAPHIC DESIGNER	<u>Chelsea Luehrs</u>	DATE	<u>11/01/2023</u>